

# RADIO CRAFT

GI AMATEUR  
RADIO CLUB  
STATION  
SEE PAGE 828



*In this issue—*

Audio Response Correction  
Rebuilding a Televiser  
Design of Audio Mixers

RADIO-ELECTRONICS IN ALL ITS PHASES

SEPT

1946

25¢

CANADA 30¢

# PANORAMIC RECEPTION

attends the opening of the 20 and 40 meter bands

When the 20 and 40 meter bands reopened for amateur communication with all the excitement and ceremony that usually accompanies a "first night," a Panadaptor sat in on the fun. Below is an account, with illustrations, of the activity that took place before, during and after that long-awaited ham occasion.

(As Viewed by W2LNP)

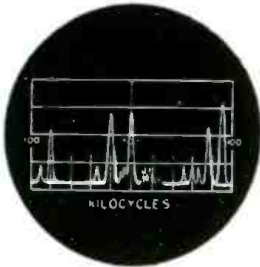

**THE STAGE WAS SET!** At approximately 11:30 P.M. the British Broadcasting Company and a Spanish station were still to be seen and heard on the 40 meter band. Their signals occupied the center of the screen. On the edge of the screen, but outside of the band, were a few cw and phone stations.

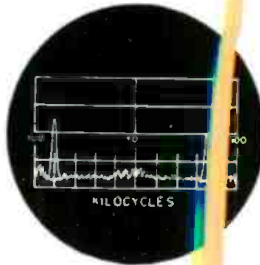

**12 MIDNIGHT!** All activity within the band ceased. The stations on the outside fringe remained on.

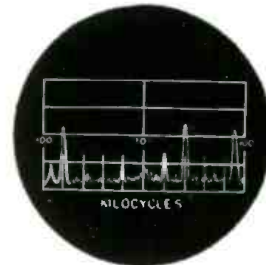

**2:00-2:30 A.M.!** Signals appeared on the band. Patterns of deflections showed that these were only carriers, and not actual communications.

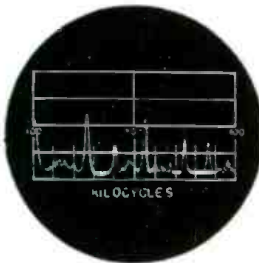

**4 A.M.!** And the official message from the official station of ARRL, W1AW, announced to all amateurs that the 20 and 40 meter bands were again their property.



**4:05-4:30 A.M.!** Within a few minutes of the announcement, about fifteen stations were on the air. . . . early on W2LNP, the station to which the Panadaptor was rigged, exchanged greetings with W5EY in Fontana, California, and a station whose signal appeared on the screen.

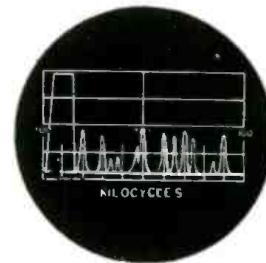

**4:45 A.M.!** The number of stations on the air was growing. And activity on the 40 meter band appeared to be normal for the first time in many years. About the same time, a large signal suddenly sprang up . . . which appeared to be a local station. This was found to come from KZ5AA in Panama, C.Z.

Only with Panoramic Reception was it possible to see a Panoramic picture of what was happening and where. Panoramic Reception permits you to do the same every day of the year! With it, you can see a continuous visible picture of band activity that enables you to spot signals . . . and to identify them. It adds to the efficiency . . . ease of operation . . . fun . . . of amateur radio. See it at your radio parts jobber now.

Get what you're missing



. . . with PANADAPTOR

The PANADAPTOR, Model PCA-2, is a 10 tube electronically tuned superheterodyne with a self-contained scope, complete for 115V, 50-60 cycle operation, at ONLY \$99.75 net. GUARANTEED FOR ONE YEAR.

**PANORAMIC**

CABLE ADDRESS  
PANORAMIC NEW YORK



**RADIO CORPORATION**

242-250 WEST 55<sup>th</sup> ST. New York 19, N.Y.

Exclusive Canadian Representative: Canadian Marconi, Ltd.



Building this  
**A. M. SIGNAL GENERATOR**  
gives you valuable experience. Provides amplitude-modulated signals for test and experiment purposes.

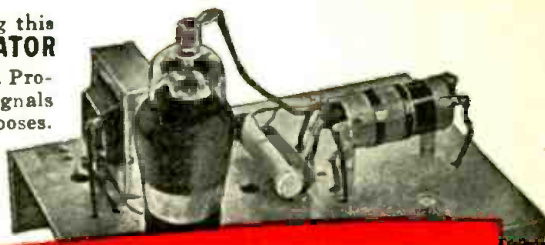

**RADIO SERVICING**

pays good money for full time work. Many others make \$5, \$10 a week EXTRA fixing Radios in spare time.

# Learn RADIO by PRACTICING in Spare Time

## with 6 Big Kits of Radio Parts I Send You



You build this  
**SUPERHETERODYNE CIRCUIT**  
that brings in local and distant stations. You get practical experience putting this set through fascinating tests.

You build this  
**MEASURING INSTRUMENT**  
yourself early in the course—use it for practical Radio work on neighborhood Radios to pick up EXTRA spare time money!

Do you want a good-pay job in Radio—or your own money-making Radio Shop? Mail Coupon for a FREE Sample Lesson and my FREE 64-page book, "Win Rich Rewards in Radio." See how N.R.I. gives you practical Radio experience at home—building, testing, repairing Radios with 6 BIG KITS OF PARTS I send!

**Many Beginners Soon Make Good EXTRA Money in Spare Time While Learning**

The day you enroll I start sending EXTRA MONEY JOB SHEETS. You LEARN Radio principles from my easy-to-grasp, illustrated lessons—PRACTICE what you learn with parts I send—USE your knowledge to make EXTRA money fixing neighbors' Radios in spare time while still learning! From here it's a short step to your own full-time Radio Shop or a good Radio job!

**Future for Trained Men Is Bright in Radio, Television, Electronics**

It's probably easier to get started in Radio now than ever before because the Radio Repair business is booming. Trained Radio Technicians also find profitable opportunities in Police, Aviation, Marine Radio, Broadcasting, Radio Manufacturing, Public Address work. Think of even greater opportunities as Television and Electronics become available to the public! Send for free books now!

**Find Out What N.R.I. Can Do For You**

Mail Coupon for Sample Lesson and my 64-page book. Read the details about my Course. Read letters from men I trained, telling what they are doing, earning. See how quickly, easily you can get started. No obligation! Just MAIL COUPON NOW in an envelope or paste it on a penny postal. J. E. Smith, President, Dept. 6JX, National Radio Institute, Pioneer Home Study Radio School, Washington 9, D. C.

**BE A SUCCESS in RADIO I Will Train You at Home**

**Sample Lesson FREE**



Gives hints on Receiver Servicing, Locating Defects, Repair of Loudspeakers, I.F. Transformer, Gang Tuner, Condenser, etc., 31 illustrations. Study it—keep it—use it—without obligation! Mail coupon NOW for your copy!



**GET BOTH 64 PAGE BOOK SAMPLE LESSON FREE**

MR. J. E. SMITH, President, Dept. 6JX  
NATIONAL RADIO INSTITUTE, Washington 9, D. C.  
Mail me FREE, without obligation, Sample Lesson and 64-page book, about how to win success in Radio and Television—Electronics. (No Salesman will call. Please write plainly.)

Age .....

Name .....

Address .....

City ..... Zone ..... State .....



**My Course Includes Training in TELEVISION--ELECTRONICS Frequency Modulation**

APPROVED FOR TRAINING UNDER GI BILL

# NEW 7-PIECE STORE DISPLAY FOR N.U. DEALERS

store-wide promotion  
in a new, flexible,  
easy-to-fit-in form



## Order yours today from your N. U. Distributor

Be one of the first to show this brand new display idea—that sells your service skill and tells customers how and why you can insure their radio enjoyment. Full of life, action and interest—printed in 10 colors on heavy cardboard—each unit is a complete display with easel and ribbon streamer. Display them as a group or as individual window, counter or shelf cards. Order from your N.U. Distributor now for immediate shipment.

NATIONAL UNION RADIO CORPORATION, NEWARK 2, NEW JERSEY

# NATIONAL UNION RADIO TUBES AND PARTS

Transmitting, Cathode Ray, Receiving, Special Purpose Tubes • Condensers • Volume Controls • Photo Electric Cells • Panel Lamps • Flashlight Bulbs



# CALRAD "hard-to-get" RADIO VALUES!

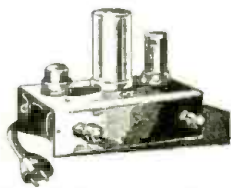

## SPECIAL! Two-Tube Phono Oscillators

Make any record player wireless with brand new TWO-TUBE PHONO OSCILLATORS Operates as far as 100 feet from a radio and can be used with Automatic Record Changers, Players or Microphone.

Uses 1-12SH7 and 1-12H6 Tubes. Complete with tubes \$8.75 net. Supplied in kit form with "easy-to-follow" instructions for assembly. Complete with all parts, instructions and tubes

**\$4.95** net

## 4 Prong Electronic Universal Vibrator

Fits 80% of all replacements. Individually boxed.

**\$1.25** each



**TURNER CRYSTAL MIKE**  
With 100 ft. Shielded Mike Cable  
**\$7.95** each

## VARIABLE CONDENSERS

Single Gang 440 Mmf Variable Condensers **95c ea.**

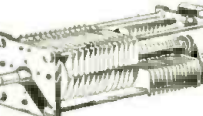

Dual Spaced 110,110 Mfd Variable Condensers **95c ea.**

Dual Spaced 170,170 Mfd Variable Condensers **95c ea.**

## 5 Tube Super AC-DC PARTS KIT

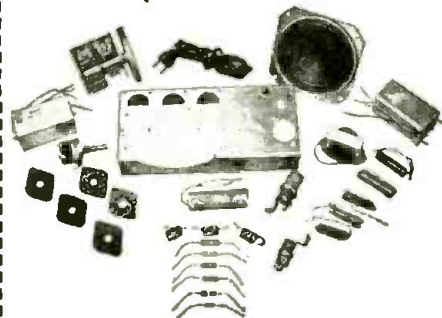

Kits include: Stamped Chassis—Dynamic Speakers—Output Transformer—Volume Control and Switch—2 Shielded I.F. Coils—Antenna and Osc. Coils—Two-gang Super Variable—50 Octal Sockets—20 x 20 Mfd. 150 Volt Filter—5 Tubular Condensers—3 Mica Condensers—6 Resistors—6 ft. AC Cord and Plug—Circuit Diagram.

While They Last **\$8.95 ea.** Lots of 6 **\$50.00**



## BRAND NEW Weston Volt Ohmmeter MODEL 663

Complete with carrying case and leads  
List \$71.50

**\$39.50**

Limited Quantity Special

## AUTO ANTENNAS

• 3 Sections • Brass Tubing  
• 66" Long • Triple Chromium Plated  
• 2 Insulator Type Cowl Individually Boxed  
• Upright aluminum can, 1 1/2 in. x 3/4 in. List \$4.50.  
Replaces 8 mfd. 600 Vo. electrolytic. 95c ea.

**\$30.00**

Lots of 48 **\$55.00**

Immediate Delivery But Quantity Is Limited.

## V.M. TWO POST AUTOMATIC RECORD CHANGER



This Record Changer is a well-made mechanism, will play either 10-in. or 12-in. records. The pickup uses a crystal cartridge. Size 14 in. x 14 in. Packed 2 to a factory-sealed carton, factory guaranteed.

CARTON OF 2 **\$35.00 Special \$18.95 ea.**

## T-17B MICROPHONE

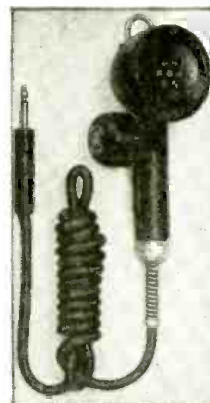

Made of durable plastic. Complete with 5 ft. rubber coated cord and plug PL-68. Press-to-talk button. Can be used with most radio sets as home broadcaster mike for entertainment.

**\$1.95** each

SUPPLY IS LIMITED! ACT QUICKLY

# BUY NOW! LOWEST PRICES! STOCKS LIMITED!

Fully Shielded Power Transformers  
50 Mill—6.3 Vo. @ 2 amp. C.T.—5 Vo. @ 2 amp. C.T.—650 Vo. C.T. \$2.25 ea. Lots of 10 \$2.00 ea.  
90 Mill—6.3 Vo. C.T. @ 3 1/2 Amp—5 Vo. @ 3 Amp. C.T.—750 Vo. C.T.—\$2.95 ea.  
200 Mill—300 Vo. C.T.—6.3 Vo. C.T. @ 5 Amp.—5 Vo. C.T. @ 3 Amp.—\$4.95 ea.

Push Pull 6L6 Shielded Output Transformer  
30 Watt Peak, to 2-4-6-8-16-250 and 500 ohm line. \$3.45 ea. Lots of 12, \$3.25 ea.

Push Pull Input Transformer, 10,000 ohm plate to push pull 6L6—\$1.10 ea. Lots of 12—\$1.00 ea.

Midget Universal Output Transformer—push pull plate to 2-4-6-8-10-16 ohm voice coil—95c ea. Lots of 10—85c ea.

10 Watt Large Universal Output—\$1.35 ea. Lots of 10—\$1.20 ea.

Single Pentode Midget Output—for 50L6, 6V6, 6F6, etc.—55c ea.

50 Mill Filter Choke 300 ohm—65c ea. Lots of 10—60c ea.

75 Mill Filter Choke 250 ohm—95c ea. Lots of 10—85c ea.

100 Mill Filter Choke 250 ohm—\$1.10 each. Lot of 25—\$1.00 ea.

### DYNAMIC AND P.M. SPEAKERS

4-in. 450-Ohm Dynamic—\$1.75 ea.  
4-in. 2500-Ohm Dynamic—\$1.65 ea.  
4-in. P.M. Heavy Slug—\$1.60 ea.  
5-in. P.M. Heavy Slug—\$1.65 ea.  
6-in. P.M. Heavy Slug—\$2.25 ea.

### TUBULAR ELECTROLYTIC CONDENSERS

10 Mfd. 50 Volt—21c ea.  
25 Mfd. 50 Volt—24c ea.  
50 Mfd. 50 Volt—28c ea.  
100 Mfd. 50 Volt—35c ea.  
16 Mfd. 150 Volt—25c ea.  
20 Mfd. 150 Volt—28c ea.  
24 Mfd. 150 Volt—30c ea.  
30 Mfd. 150 Volt—32c ea.

50 Mfd. 150 Volt—35c ea.  
8 Mfd. 450 Volt—30c ea.  
20 Mfd. 450 Volt F.P.—50c ea.  
20 x 20 Mfd. 150 Volt—43c ea.  
30 x 20 Mfd. 150 Volt—47c ea.  
40 x 20 Mfd. 150 Volt—55c ea.  
50 x 30 Mfd. 150 Volt—65c ea.

Standard Brands. Tubular By-Pass Condensers  
.001-.002-.003-.005-.006-600 Volt \$6.75 per 100  
.025-.01-.02-600 Volt \$2.75 per 100  
-05-600 Volt \$8.50 per 100  
1-600 Volt \$9.50 per 100  
25-600 Volt \$15.00 per 100  
5-600 Volt \$19.00 per 100  
4 Mfd. 600 Vo. T.L.A. Oil Condenser, screw base. Upright aluminum can, 1 1/2 in. x 3/4 in. List \$4.50. Replaces 8 mfd. 600 Vo. electrolytic. 95c ea.

### FINEST QUALITY MIDGET MICAS:

.001-.0001 .005-.00005 \$5.00 per 100  
.002-.00025 .006-.0005 \$40 per 1000  
Astatic Low Pressure, curved arm, crystal pickup with Saphire Stylus Permanent Needle, has cartridge which replaces LP6-LP21-LP23. \$3.50 ea.; Lots of 10 \$32.50.

Standard Low Pressure Crystal Pickup. \$2.25 ea.; Lots of 10—\$20.00

Signal Corps Dual Headsets—8000 ohms high impedance, with 2 rubber ear cushions, cord and phone plug. Individually boxed, \$12.50 list, net \$1.95 ea.

456 K.C. Antenna, Oscillator and R.F. Coils, 25c ea.

456 K.C. I.F. Coils Input & Output, medium size can. 59c ea.

Mallory No. 534C—6 prong, 6 Volt, Synchronous Vibrator, Equivalent to Mallory No. 742. \$1.75 ea. Lots of 10—\$15.00.

Kit of 50 assorted Bakelite Knobs for 1/4-in. shaft, with set screws. \$2.50 per kit

Kit of 50 assorted wood knobs for 1/4 in. shaft with set screw—\$3.50 per kit.

Midget Ceramic Trimmers—3-30 mmf., 6c ea.

Western Electric—0-200 Microammeter—3 in bakelite case. \$4.25 ea.

Tinned Copper Shielding—1/4 in., 1/2 in., \$1.50 per 100 ft.

Rubber Sheathed "Mike" Cable, shielded, single Conductor 100 ft. for \$ 5.95

Moulded Octal Sockets 1/2-in. mtg. with metal ring 500 ft. for \$25.00

6 ft. A.C. Cords with plug. 7.00 per 100

Volume Controls, less Switch—1/2-in. shaft 250,000 ohm. Lots of 100 39c each

1 Meg 2 Meg \$30.00

250 ft. Coil Underwriter Approved Zip Cord—\$4.25 per coil.

Single Bearing Midget Condenser 14 Plate—100 Mfd. 50c ea.

Midget two-gang Super Variable Condenser. .00365 Cmp. Cut Oscillator Section—\$1.50 ea.

Midget Open Circuit Jack—Lots of 10—\$1.50

Midget Closed Circuit Jack—Lots of 10—\$2.00

Midget Double Circuit Jack—Lots of 10—\$2.00

Insulated Banana Tip Jacks, red or black \$8.50 per 100

Standard Barrel Type Phone Plug 22c ea.

4 Tap Midget Loop Antenna Size 7 1/4"x5"—35c ea.

500,000 Ohm Volume Control with Switch—2" Shaft 69c ea.

1 Meg Ohm Volume Control with Switch—2" Shaft 69c ea.

10 Watt Wire Wound Resistors, your choice of sizes 25 Ohm to 25,000 Ohm—20c ea.—\$17.50 per 100

Buffer Condensers (Famous Make) .005, .01, .02—1700 Volts—19c ea. Lots of 50—15c ea.

Signal Corps Telegraph Keys lots of 10—60c ea. lots of 50—50c ea.

Webster Model #56 Record Changer—\$25.95 ea. Lots of 3—\$25.00 ea.

Webster Model #50 Record Changer—\$19.95 ea. Lots of 3—\$19.00 ea.

Model A 100 Signal Generator—\$47.00 ea.

Mazda Pilot Light Bulbs #40 and #44 Packed 100 to carton—\$3.75 per 100

## MAIL ORDERS FILLED:

25% deposit, balance C.O.D.

Orders Under \$10.00 Please Remit In Full.

References—Bank of America, Santa Monica and Vermont Avenues, Los Angeles, Calif.

# CALIFORNIA RADIO & ELECTRONICS CO.

Dept. No. C. 711 No. Vermont Ave., Los Angeles 27, California

# RADIO SERVICE MEN

## HERE IS YOUR GUIDE TO BETTER SERVICE TECHNIQUE

It's boom time for the radio service business! Millions of new radios and complicated television, F-M and facsimile equipment—all requiring installation and service—are coming on the market. Sets and systems already in use are crying for expert maintenance service. Yes, from now on, every day will be field day for you radio service men. And you'll want to be fully prepared . . . with up-to-date knowledge of methods, equipment and new developments in the industry. You'll want to know the easiest and quickest ways to do your service jobs and make bigger-than-ever profits. That's why you'll want to subscribe to RADIO MAINTENANCE, the trade magazine published especially for you. RADIO MAINTENANCE covers all problems of a radio shop . . . presents comprehensive, technically complete information on servicing A-M, Television, F-M . . . better use of test equipment, and P. A. Systems . . . brings you authoritative articles by the best-known, best-qualified men in the field. It can be the handiest tool in your kit . . . the most valuable piece of equipment in your shop. It's a magazine you'll read . . . and enjoy . . . and USE!

TO KEEP SERVICE MEN COMPLETELY AND ACCURATELY INFORMED ABOUT:

- TEST EQUIPMENT
- TROUBLE SHOOTING PROCEDURES
- PUBLIC ADDRESS SYSTEMS
- ALIGNMENT TECHNIQUES
- INSTALLATION AND MAINTENANCE



**RADIO MAINTENANCE MAGAZINE**  
460 Bloomfield Avenue, Montclair, N. J.

Please enter my subscription as follows:

For 12 Issues  
at \$2.00   
For 24 Issues  
at \$3.00

NAME \_\_\_\_\_

OCCUPATION \_\_\_\_\_

ADDRESS \_\_\_\_\_

CHECK ENCLOSED CITY \_\_\_\_\_

BILL ME LATER ZONE \_\_\_\_\_ STATE \_\_\_\_\_

NOT SOLD AT NEWSSTANDS  
BY SUBSCRIPTION ONLY

**ONE ISSUE FREE** IF PAYMENT IS ENCLOSED

# LET ME TRAIN YOU

for RADIO ELECTRONICS & TELEVISION

# I'll Supply a FULL RADIO SET

for SIMPLIFIED INSTRUCTION — PRACTICE & TESTING

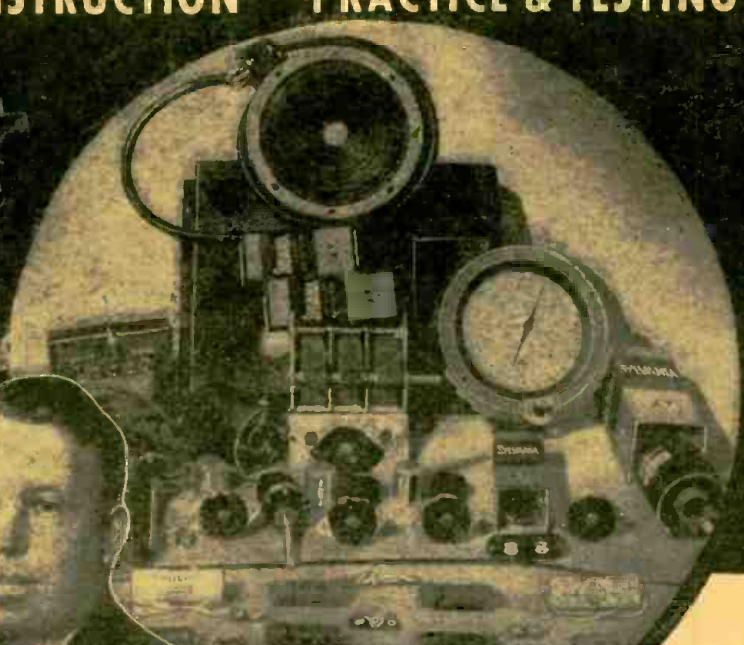

**Beginners Learn FAST**  
**START NOW!** Big Developments  
 Ahead in F. M., Radar, Television

**MAKE GOOD MONEY IN**  
**a Business of Your Own**  
 ...or a Good Radio Job.



Mind training through hand practice with a FULL RADIO SET . . . that's the interesting way I'll teach you Radio. And it's the latest, most practical method of all to fix in your head permanently the essential money-making Radio knowledge. The offer I make you here is the opportunity of a lifetime. I'll prepare you easily and quickly for a wonderful future in the swiftly expanding field of Radio-Electronics INCLUDING Radio, Television, Frequency Modulation and Industrial Electronics. Be wise! NOW'S the time to start. Opportunities ahead are tremendous! No previous experience is necessary. The Sprayberry Course starts right at the beginning of Radio. You can't get lost. It gets the various subjects across in such a clear, simple way that you understand and remember. And, you can master my entire course in your spare time . . . right at home.

**You Do Practical Experiments**

There's only one right way to learn Radio Electronics. You must get it through simplified lesson study combined with actual "shop" practice under the personal guidance of a qualified Radio Teacher. It's exactly this way that Sprayberry trains you . . . supplying real Radio parts for learn-by-doing experience right at home. Thus, you learn faster, your understanding is clear-cut.

**I'll Show You a New, Fast Way to Test Radio Sets Without Mfg. Equipment**

The very same Radio Parts I supply with your Course for gaining pre-experience in Radio Repair work may be adapted through an exclusive Sprayberry wiring procedure to serve for complete, fast, accurate Radio Receiver trouble-

shooting. Thus, under Sprayberry methods, you do not have one cent of outlay for manufactured Test Equipment.

**Succeed As a Radio-Electronician**

My training will give you the broad, fundamental principles so necessary as a background, no matter which branch of Radio you wish to specialize in. I make it easy for you to learn Radio Set Repair and Installation Work. I teach you how to install and repair Electronic Equipment. In fact, you'll be a fully qualified RADIO-ELECTRONICIAN, equipped with the skill and knowledge to perform efficiently and to make a wonderful success of yourself.

**Read What Graduate Says**  
**"One Job Nets About \$26.00"**

"Since last week I fixed 7 radios, all good-paying jobs, and right now I am working on an amplifier system. This job alone will net me about \$26.00. As long as my work keeps coming in this way, I have only one word to say and that is, 'Thanks' to my Sprayberry training, and I am not afraid to boast about it."—ADRIEN BENJAMIN, North Grosvenordale, Conn.

**DON'T PUT IT OFF!**

Get the facts about my training—now! Take the first important step toward the money-making future of your dreams. All features are fully explained in my big, illustrated FREE Catalog which comes to you along with another valuable FREE book you'll be glad to own.

## FREE BOOKS

"How To Read Radio Diagrams and Symbols"

Here's a valuable and wonderfully complete new book which explains in simple, non-technical English how to read and understand any Radio Set Diagram. Provides the quick key to analyzing any Radio circuit. Includes translations of all Radio symbols. This instructive volume is yours for the asking—without obligation. Send for it AT ONCE, and along with it I will send you another big free book, describing in complete, interesting detail my Radio-Electronic training.

**RUSH**  
**COUPON**  
 for **BOTH**



**SPRAYBERRY ACADEMY OF RADIO**  
 F. L. Sprayberry, President  
 Room 2096, Pueblo, Colorado

Please rush my FREE copies of "How to MAKE MONEY in RADIO ELECTRONICS and TELEVISION," and "How to READ RADIO DIAGRAMS and SYMBOLS."

Name ..... Age.....  
 Address .....  
 City ..... State.....  
 (Mail in envelope or paste on penny postcard)

**MAIL COUPON AT ONCE!**

# RADIO CRAFT

AND POPULAR ELECTRONICS

Incorporating  
SHORT WAVE CRAFT TELEVISION NEWS  
RADIO & TELEVISION



**HUGO GERNSBACK, Editor-in-Chief**  
**FRED SHUNAMAN, Managing Editor**  
**M. H. GERNSBACK, Consulting Ed.**  
**R. F. SCOTT, W2PWG, Technical Editor**  
**I. QUEEN, W2OUX, Editorial Associate**  
**ELMER FULLER, Shortwave Editor**  
**A. PASCALE, Production Manager**  
**G. ALIQUO, Circulation Manager**  
**JOHN J. LAMSON, Advertising Director**  
**ALFRED STERN, Promotion Manager**

## IN AN EARLY ISSUE

Instability in Apparatus  
5-Tube Superheterodyne  
Electromagnets in Radio  
Complete Tracer in Probe  
Aviation Radio Servicing

Published by Radercraft Publications, Inc.  
Publication Office: 29 Worthington Street, Springfield 3, Mass.  
Editorial and Advertising Offices: 25 West Broadway, Tel. RE 2-9690, New York 7, N. Y.  
Chicago Advertising Office: Radio-Craft, 308 W. Washington Street, Suite 1413, Chicago 6, Ill. Tel. Randolph 7363.  
Cleveland Advertising Office: 405 Erie Bldg., Cleveland, Ohio. Burdette Phillips, Manager. Tel. Main 9645.  
Detroit Advertising Office: 307-8 Boulevard Bldg., Detroit, Mich. C. Frank Holstein, Manager.  
Los Angeles Advertising Office: 606 South Hill Street, Los Angeles 14, Calif. Ralph W. Harker, Manager. Tel. Tucker 1793.  
San Francisco Advertising Office: 582 Market St., San Francisco 4, Calif. Ralph W. Harker, Manager. Tel. Garfield 2481.  
RADIO-CRAFT is published monthly on the 25th of the month preceding that of date.  
Subscription rates: United States and possessions, Mexico, Central and South American countries, \$2.50 a year, \$4.00 for two years, \$6.00 for three years. Canada, \$3.00 a year, \$5.00 for two years, \$7.50 for three years. All other foreign countries, \$3.25 a year, \$5.50 for two years, \$8.25 for three years. Special rates for members of the Armed Forces in U. S., or those addressed by A.P.O. or P.P.O. mail, \$2.00. Entered at the post office at Springfield as second-class matter under the Act of March 3, 1879. All communications about subscriptions should be addressed to: Circulation Manager, Radio-Craft, 25 West Broadway, New York 7, N. Y.

Notice of CHANGE of ADDRESS should reach us at least one month in advance. When ordering a change, please furnish an address stencil impression from a recent wrapper if you can. Address changes cannot be made without the old address as well as the new.

### Foreign Agents

London—Atlas Publishing and Distributing Co., Ltd., 18 Bride Lane, Fleet St., London, E.C. 4.

Melbourne—McGill's Agency, 179 Elizabeth St., Australia.

Text and illustrations of this magazine are copyright and must not be reproduced without permission of the copyright owners. Copyright, 1946, Radercraft Publications, Inc.

### RADCRAFT PUBLICATIONS, INC.:

Hugo Gernsback, *President*  
M. Harvey Gernsback, *Vice Pres.*  
G. Aliquo, *Secretary*

## Contents September, 1946 Volume XVII No. 12

Editorial: Is Television Really Here? .....	by Hugo Gernsback	821
Radio-Electronics Monthly Review .....		822
Atom Bomb over Bikini .....	by E. A. Witten	824
Transatlantic News .....	by Ralph Hallows	841
Radio Thirty-five Years Ago .....		859

## ELECTRONICS AND TELEVISION

Black-Light Telescope .....	by Sanford Essig	826
Rebuilding a Televiser .....	by Norman Chalfin	832
Television for Today, Part IV, Television R.F. and I.F. Stages .....	by Milton S. Kiver	840

## AMATEUR RADIO

V.H.F. Receiver .....	by R. L. Parmenter	825
Army-Amateur Radio Club (Cover Story) .....	by Capt. L. A. Olson	828

## SERVICING

The Postwar Radios: Arvin Model 444 .....		836
Radio Test Equipment .....	by Shepard S. Litt	837
Radio Data Sheet No. 339 (Olympic Models 6-501, 502, 503) .....		839

## SOUND

Audio Response Correction .....	by John W. Straede	827
Audio Mixer Design .....	by John B. Ledbetter	834

## CONSTRUCTION

Germanium Crystal Probe .....	by R. E. Altomare	830
Link-Coupled Crystal Set .....	by Carroll Utermahlen	831

## DEPARTMENTS

World-Wide Station List .....	by Elmer R. Fuller	842
New Radio-Electronic Devices .....		844
Radio-Electronic Circuits .....		854
Try This One .....		856
The Question Box .....		858
New Radio-Electronic Patents .....		860
Communications .....		880
Book Reviews .....		883

Biographical Portrait drawings by Constance Joan Naar



## ON THE COVER

The Army-Amateur radio station, W2OEC, at Fort Monmouth, New Jersey, is depicted on our cover this month. Home of the Signal Corps, Fort Monmouth is crowded with hams from all districts of the United States, who are able to keep up with the postwar ham world by means of the station.

Chromatone by Alex Schomberg from Signal Corps Photo



SOON WE'LL PHONE HOME FROM AUTO  
 RADIO INDUSTRY POISED FOR BIG BOOM  
 Big Boom in FM Broadcasting  
 Seen  
 MARKET FOR 100 MILLION RADIOS REVEALED BY PENNSYLVANIA SURVEY  
 OVER FIVE- OR SIX-YEAR PERIOD, RESIDENTS  
 COAST TO COAST NETWORK BEING PLANNED FOR FM

Let TODAY'S HEADLINES Guide You to TOMORROW'S OPPORTUNITIES

# Learn RADIO ELECTRONICS THIS MODERN "A-B-C" WAY .. at Home



Plan your future the way business men do: Watch the headlines! Pick a field that's "in the news"—one with many opportunities for interesting, PROFITABLE EMPLOYMENT or a good chance for establishing a BUSINESS OF YOUR OWN with little capital. Pick a field that offers a variety of interesting opportunities—a field with one of America's most promising futures . . . and see how you may MAKE YOUR START TOWARD A PLACE IN THIS FIELD BEFORE JOB COMPETITION BECOMES ACUTE. Write for our Big, Free, Illustrated Book—"VICTORY FOR YOU." Learn how DeForest's Training, Inc. prepares you at home, in your leisure time—without interfering with the work you are now doing—then helps you make your start in the vast BILLION DOLLAR Radio-Electronics field.

### You Get EMPLOYMENT SERVICE

Our Employment Service offers you the advantage of long and favorable contacts with some of America's foremost Radio-Electronics concerns. "VICTORY FOR YOU" tells you how this Service has helped many to their start in Radio-Electronics. You'll see how our students and graduates are prepared to win and to hold good paying jobs—how they start businesses of their own with little, if any, capital.

## A You "LEARN-BY-DOING" at Home with Practical Equipment

Enjoy a "Home Laboratory." We provide you with 8 BIG KITS OF RADIO ASSEMBLIES AND PARTS to give you valuable practical experience at home. Build modern Radio Receivers and Circuits that operate. Build Electric Eye Devices, an Aviation Band Receiver, a Public Address System, a Wireless Microphone and numerous other fascinating experiments—in fact, 133 in all, in your spare time at home. NEW colorful Kit Supplement tells you about our "Home Laboratory," and how you use valuable Radio parts and sub-assemblies to get real practical experience as you learn.

## VETERANS!

Big things are happening at DeForest's Training, Inc. for veterans! See how you can prepare yourself without cost for a good job or a business of your own in the vast Radio-Electronic opportunity field.

## C WELL-ILLUSTRATED LOOSE-LEAF LESSONS

You also receive modern loose-leaf lessons that are easy to read and are well illustrated with many helpful pictures and diagrams. ACT PROMPTLY. See how you can learn Radio this modern A-B-C way by Reading . . . by Doing . . . by Seeing—at Home. Mail Coupon Now!

## B Home MOVIES Help You Learn FASTER...EASIER

You also use a 16 mm. Motion Picture Projector and exciting training films to help you learn some of Radio's fundamentals FASTER . . . EASIER. SEE what happens inside of many circuits you are working on. SEE how electrons function. SEE how RADIO waves are changed into sound. Get our big, free book! Use it as a key to show you the way to Radio-Electronics job opportunities of today and tomorrow—the opportunities the headlines tell about.



SEND FOR FREE BOOK & SUPPLEMENT TODAY!

# DeFOREST'S TRAINING INC., Chicago, Ill.

DeFOREST'S TRAINING, INC.,  
 2533-41 N. Ashland Ave., Dept. RC-C9  
 Chicago 14, Illinois, U. S. A.  
 Send me both your big book "VICTORY FOR YOU" and Kit Supplement, showing how I may make my start in Radio-Electronics with your modern A-B-C home training plan. No obligation.

Name ..... Age .....  
 Address ..... Apt. ....  
 City ..... Zone ..... State .....

If under 16, check here for special information.  If a discharged veteran of World War II, check here.



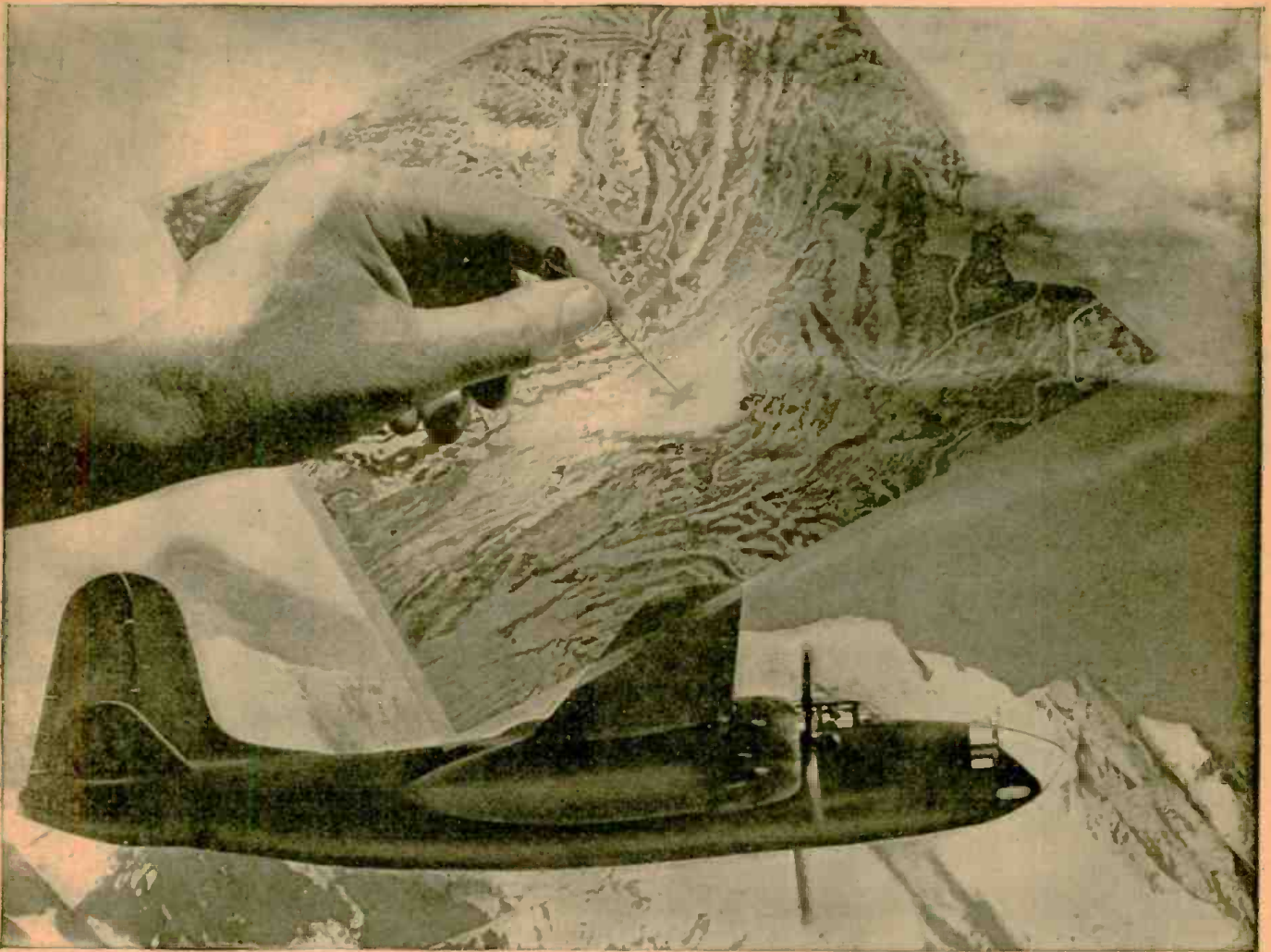

*Developed by RCA as an aid to blind bombing in wartime, Shoran is a new radar yardstick for world mapping*

## **SHORAN—a surveying system**

***with pin-point accuracy!***

One small error in a map can be costly in the location of an oil well or mining property. But with Shoran, vast areas can now be charted by plane with an error of less than twelve inches in five miles—and in a matter of minutes or hours as opposed to weeks or months that would be required by laborious surveys made on the ground. Shoran is called one of the most important geographic inventions since the compass.

Shoran can also direct a plane flying in a blackout or heavy overcast with such accuracy that during the war it

was possible to drop bombs only a few hundred feet ahead of completely invisible advancing troops below with unerring precision.

Just as Shoran is a revolutionary stride forward in map-making, so do all RCA products represent the farthest point of progress in their fields.

And when you buy anything made by RCA or RCA Victor, you are sure of getting one of the finest instruments of its kind science has achieved.

*Radio Corporation of America, RCA Building, Radio City, New York 20. Listen to The RCA Victor Show, Sundays, 2:00 P. M., Eastern Daylight Time, over NBC Network.*



Until recently a closely guarded military secret, Shoran was developed at RCA Laboratories—a world center of radio and electronic research. Here, in this vast community of scientists, the same imagination and skills that developed Shoran keep RCA and RCA Victor the outstanding names in radio, television and recorded entertainment.



**RADIO CORPORATION of AMERICA**

**MAKE MORE MONEY**

**IN**  
**Radio TELEVISION & ELECTRONICS**

**Now!**

**GET THESE 2 BIG BOOKS**

You men already in Radio know how great the demand is for trained, experienced servicemen, operators and technicians. You know how fast the field is growing and how important it is to keep up with developments — F.M. Receivers, Electronics and Television. You know, too, a fellow cannot learn too much about any industry for **REAL SUCCESS**. Whether you have experience or are merely **INTERESTED** in radio as an amateur, you must recognize the **WONDERFUL OPPORTUNITY** right within your grasp to cash in on your natural abilities. Make them pay dividends. Get into the **EXPERT RADIO SERVICE FIELD**. Be an F.M. and **TELEVISION specialist—OWN A BUSINESS OF YOUR OWN**, if you prefer. Fill out and mail the coupon below for all the details of our plan.

Get the Latest Inside Information—Short Cuts—Trade Secrets by

Here's Just a Few of the Interesting Facts you Learn with the **FREE MANUAL**.

1. Routine for diagnosing Radio Troubles.
2. Preliminary Inspection of Receivers.
3. How to Check Power Supply.
4. How to Identify Various Stages of Receiver.
5. How to Trace the Circuit and Prepare Skeleton Diagram.
6. How to Test and Measure Voltages.
7. How to Test Speaker in Audio Stages.
8. How to Test Detector, I. F., R.F., and Mixer Stages.
9. Complete Reference Table for Quickly Locating Receiver Troubles.

**FREE!**



**SHOP METHOD HOME TRAINING**

FROM A REAL ESTABLISHED RESIDENT SCHOOL

Now the famous National Schools brings its exclusive Shop-Method of training right into your own home. You can learn the most up-to-date, approved projects, systems and circuits step by step in your spare time. This is the sound practical training you want and need—the development of experienced instructors working with thousands of students right in shops, NEW F.M. broadcast studios and experimental laboratories of **NATIONAL SCHOOLS**—one of the most advanced trade educational centers in the world.

**National Trained Men Now Making the Best Money in History**

The real value of National training shows up on the quick progress our men make on the job.

Incomes that seemed fantastic only a short time ago are now being reported by National graduates. And this is only a sample of what the future holds for the **MAN WHO KNOWS RADIO, ELECTRONICS, F.M., TELEVISION** and allied subjects. National is proud of the progress its graduates are making all over the world. Read the facts—the actual proof in the books we send you **FREE**.



**LEARN BY DOING**

Work with Real Experimental Equipment Furnished without Extra Cost as Part of Your National Training

*Experience is the best teacher.* You learn by experience with the exclusive National Shop-Method of Home Training. In the course of your study you actually build various types of receivers—a powerful superheterodyne, a signal generator, an audio oscillator and others—You make tests and conduct experiments that *show you the why and how of things*. You understand what makes the various elements of electronics operate because you actually see them work for you. Not only do you gain marvelous experience by this method of learning but you receive valuable equipment you will use on the job in the practice of your profession as an electronics expert. *Mail the coupon* and learn what this means to you.

Send the Coupon and prove to yourself what YOU can do in **RADIO!**

**Be Sure Of Your Success And Security After The War**

Don't let your post-war ambitions lag. Don't let YOUR future depend on others. Build a career for yourself. Never in all history has the returning serviceman, or war worker been confronted with such a great future if he reaches out and grasps it **NOW**. Here is a new world opening before you. Get ready now while you are still in uniform—while you are on your war job. Then you can soon step into an essential, well paid position or, with little capital, **GET INTO BUSINESS FOR YOURSELF**. It isn't a bit too soon to start now. Radio men are vitally needed. Fill out and mail the coupon immediately and examine the **NATIONAL SHOP METHOD HOME TRAINING COURSE** carefully, without obligation.

**FREE LESSON INCLUDED**

Examine the exclusive National Shop Method of Home Training. See for yourself how sound and practical it is. Be convinced that you can learn Radio, Electronics, Television—quickly and easily in your spare time. You can't tell until you try. This trial is **ABSOLUTELY FREE**. Fill out the coupon immediately while you are thinking about it and drop it in the mail at once.

Mail the coupon here for the books that tell you the complete story of the marvelous new system of training in Radio, Electronics and Television. Learn the facts of this exclusive shop-method of home training. See for yourself! **DECIDE FOR YOURSELF!**

This is the **MODERN SYSTEM OF TRAINING**; it matches the rapid progress constantly being made in Radio, Television and Electronics. It is **TIME TESTED**, too. National Schools has been training men for more than a third of a century. It is the very same training that has helped thousands to more pay and greater opportunity.

You owe it to yourself—your future—to read the book "Your Future in Radio, Electronics and Television"—**FREE** to you when you send in the coupon.

**NATIONAL SCHOOLS**

LOS ANGELES 37, CALIFORNIA EST. 1905



**MAIL OPPORTUNITY COUPON FOR QUICK ACTION**

National Schools, Dept. RC-9

(Mail in envelope or paste on penny post card)

4000 South Figueroa Street, Los Angeles 37, California.

Mail me **FREE** the two books mentioned in your ad, including a sample lesson of your course. I understand no salesman will call on me.

NAME ..... AGE .....

ADDRESS .....

CITY ..... ZONE ..... STATE .....

Check here if Veteran of World War II.



## Face the Facts! You Must Keep Pace—or Be Left Behind Because You Lack the Understanding of New Techniques

***It's up to you to do something about your future in radio -- TODAY! The fight to HOLD good jobs is on . . . the opportunities to ADVANCE are here.***

Remember, this new world of radio-electronics demands a radically new technical knowledge. New receivers contain U.H.F., "FM," standard and short wave AM, and Television. Microwave transmission of natural color television is already in daily operation. Projection television receivers for the home employ 20,000 volt power supplies—some have in excess of 40 tubes. These are the jobs you'll have to service from now on.

No matter what your past or present radio experience has been, you must start anew to add to your store of technical knowledge. You must keep pace with the new developments and keep ahead of increasing competition, if you expect to get ahead to the better-paying jobs and comforting security that goes with them.

CREI technical home study training is geared to keep you abreast of the time . . . to provide

you with more advanced technical training and the ability to go after and get the good paying job you want.

CREI offers you a proved program of home study training with individual guidance and supervision from a trained instructor. This is the basis of the CREI method of training for which many thousands of professional radiomen have enrolled during the past 19 years, and which has resulted in a large number of promotions to more responsible positions and larger incomes.

It costs you nothing but a moment's time to send for the interesting facts . . . to learn how CREI can help you enjoy the security you want . . . the better-paying job that can be yours. Write for particulars today! (CREI training for Veterans is available under the G.I. Bill.)

• WRITE  
TODAY for  
FREE  
BOOKLET



"Your Opportunity in the  
New World of Electronics"

If you have had professional or amateur experience—let us prove to you that we have something you need to qualify for a better radio job. To help us to intelligently answer your inquiry—PLEASE STATE BRIEFLY YOUR BACKGROUND OF EXPERIENCE, EDUCATION AND PRESENT POSITION.

## Capitol Radio Engineering Institute

E. H. RIETZKE, President

Dept. RC-9, 3224—16th Street and Park Road, N. W.,  
Washington 10, D. C.

### Branch Offices:

NEW YORK CITY (7)  
170 Broadway

CHICAGO (2), ILL.  
30 N. LaSalle St.

SAN FRANCISCO (2),  
CALIF., 760 Market St.

SAN DIEGO (1), CALIF.  
316 C Street

Member: NATIONAL HOME STUDY COUNCIL • NATIONAL COUNCIL OF TECHNICAL SCHOOLS

# SILVER

## "VOMAX"

### 904 $\frac{C}{R}$ BRIDGE

## "SPARX"



"VOMAX" is more than a multi-meter . . . more than volt-ohm-db.-milliometer . . . more than r.f. vacuum-tube voltmeter of laboratory instrument caliber. "VOMAX" is all of these things. Born out of six years of military research and production, it is new as today. Backed by a name famous for over 35 years . . . designed by radio's only International Grand Prize winner, "VOMAX" is the standard of comparison.

RADIO MAINTENANCE engineers checked and rechecked the market for the best possible meter . . . most-used instrument in all radio service . . . to serve as heart and core of its new "Modern Test Bench." They selected "VOMAX". Your efficiency and profits will be greatest when you, too, use "VOMAX". Outstanding . . .

tested and sworn to by thousands of serious service technicians . . . ordered and reordered by the U. S. Bureau of Standards, the Naval Research Laboratory, Western Union . . . used by Sperry, Monsanto Chemical, DuPont, F.C.C. Grand Island monitoring station, C.A.A., Naval Ordnance Depots, Lapp Insulator, Stackpole Carbon, Fairchild Aviation, etc., etc. This is positive proof that "VOMAX" is the meter you must have to top smart competition. Follow the recommendation by Bendix to all BENDIX RADIO distributors and dealers . . . "Use 'VOMAX'. It's better than we hoped."

Only  
**\$59.85**



Model 904 Capacitance/Resistance Bridge.  $\frac{1}{4}$  mmfd/ohm thru 1,000 mfd/meg-ohms; 0-50% power factor; 0-500 volt adjustable internal polarizing voltage; 0-10 and 0-100 ma. electron-ray leakage current meter; measures resistance, capacitance under actual operating voltages! Also recommended by Bendix. Only \$49.00

"SPARX". Visual/aural dynamic signal tracer; 20 cycles thru 200 mcs.; new crystal rectifier r.f./a.f. probe; 65 db. a.f. amplifier; dynamic speaker Tests speakers, phono pick-ups, amplifiers, receivers from antennae thru speakers; determines presence of operating voltages, hum. Checks individual circuits and overall performance and quality quickly and positively. Only \$39.90



Get a copy of June, 1946 RADIO MAINTENANCE at your favorite jobber—or send 25c to 460 Bloomfield Ave., Montclair, N. J., for radio's newest 100% service magazine. Read all about "VOMAX" in it.

Send penny post-card for new, hot-off-the-press, catalog describing these important, fresh, postwar measuring instruments, plus 3 new communication receivers, 2 new transmitters, factory built and kits, condensers, coils, sockets, new "frequency-meter" 5 thru 500 watt, 6-band transmitting inductor, keying and quality monitor, new AM and FM signal generator covering 90 kcs. thru 170 mcs. on fundamentals! See your favorite jobber at once, for demand far exceeds supply.

OVER 35 YEARS OF RADIO ENGINEERING ACHIEVEMENT

## McMurdo Silver Company Inc.

1249 MAIN STREET • HARTFORD 3 • CONNECTICUT  
IN CANADA—MC MURDO SILVER DIVISION, GENERAL RADIONICS, LTD. 465 CHURCH ST.—TORONTO, ONTARIO, CANADA.



# BE A TELEVISION TECHNICIAN!

## Regularly Scheduled Programs are on the Air!

Two great broadcasting corporations have entered Television and are today producing programs. Other large organizations have applied for licenses to broadcast Television in all parts of the country! The sale of home receivers is now progressing. In other words, we believe it's the beginning of a vast and exciting new business. Regular Television broadcasting is *now* a reality!

### TELEVISION AND YOU

The opportunity in Television is far greater for the properly trained man. You owe it to yourself to investigate Television and to prepare yourself to become a valued part of a fascinating new profession.

### PREPARE THE "AMERICAN" WAY

The American Television Institute is the oldest and largest training organization exclusively for Television. "American" students are trained by top Television engineers with the latest commercial equipment. You will train under actual Television studio conditions. You will learn by doing. You can qualify for your chosen field with the necessary fundamental knowledge plus real studio experience and skill.

#### VETERANS ATTENTION!

The American Television Institute has been approved for Veteran's Training under the G.I. Bill of Rights. During the war, thousands of Signal Corps men were trained under contract with the War Department. Our training methods have been developed to a high degree and our school has up to the minute facilities in every respect. If you are a veteran, mark the coupon for the G.I. Eligibility Questionnaire.

#### WHICH PHASE OF TELEVISION?

The American Television Institute's tremendous facilities offer a complete selection of Television study—broadcast studio and control, broadcast transmitter, receiver installation and service—in fact, all departments are thoroughly covered in our laboratories.

#### WHEN DO YOU START?

The best time is right now! Immediately! New classes are forming every week. Use the coupon to get further details. Mail it today!

## American Television Institute

DIVISION OF

AMERICAN TELEVISION LABORATORIES, INC.

433 E. Erie Street

Chicago 11, Illinois

**MAIL THE COUPON TODAY** 

Studio Photos Courtesy of Television Station WCBW



TELEVISION STUDIO CONTROL

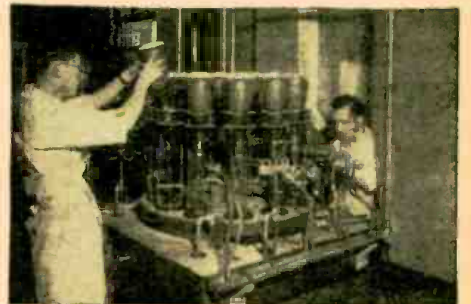

TUBE MAKING AT A.T.L.

#### REQUEST FOR FREE INFORMATION

AMERICAN TELEVISION INSTITUTE, DEPT. A  
433 East Erie Street, Chicago 11, Illinois

- Please send me complete details of your Television training.
- I am a veteran.

NAME .....

ADDRESS .....

CITY & STATE .....

# IS TELEVISION REALLY HERE?

## *The Cathode-Ray Tube Is Not the Final Solution to Television*

WE HEAR continuously from many of our readers who are bewildered—as is the general public—as to the true status of television today. There is a great deal of confusion regarding television as a whole. Nor is it abated by the industry, which itself is at odds on more than one of the art's major questions. The entire video picture is highly complex, to say the least, while little is being done to clarify the situation.

Within the industry certain factions are at odds with each other. Much could be written about such points as the disagreement between the industry and the Federal Communications Commission as to time schedules of operation, freezing of standards, etc. Within the industry one faction is for color television, which is denounced by the other. Then there is the size of screen for best viewing, whether the image should be on the cathode tube screen or whether it should be projected on the wall (or a wall screen). These are but a few points.

Commander E. F. MacDonald, Jr., President of Zenith Radio Corporation, has long taken the stand that commercial television procedure is all wrong in following the paid-advertising broadcast technique. He maintains—not without good reason—that it will never be possible to have nation-wide "free" television reception as we have "free" broadcasting. The cost of good television broadcasts is in the order of making good motion picture films. And as everybody knows, production of a good motion picture film costs anywhere from a quarter of a million dollars to two million dollars.

What makes matters worse in television is that there cannot be any "retakes." Inasmuch as a television production must be carefully rehearsed and must be letter-perfect at the moment of broadcast, the television director has no way of correcting any mistakes, as is the case in motion pictures.

Therefore, a good television broadcast program would of necessity cost more than a like motion picture production. Commander MacDonald thinks that the excessively high cost of television broadcasts cannot be met by sponsored advertising, as it is in broadcasting today, but that television programs should be paid for in some other way; either over line wires or by radio using special equipment, where only those who pay for the service would have sets that could receive such paid programs. That is one angle.

Dr. Lee deForest, of radio fame, has pointed out in an article in RADIO-CRAFT (April and May 1945 issues), the simplest way would be to take a motion picture film of the production. This could then be edited *before* the

broadcast; the final film would *then* be run at the television transmission studios and broadcast. This would make it as cheap, or cheaper than motion picture practice. Sponsored advertising programs could be presented in this way whereby the admittedly still high production costs would leave a profit to the television broadcasters. That is another angle.

This suggestion, however, is not at all welcomed by the television industry who wants none of it, but believes that television's credo is that events should be broadcast *when the event actually occurs*, instantaneously, as for instance, the recent Louis-Conn fight.

This is only one part of the story. So as not to lose our perspective, let us turn the clock back to 1921 when broadcasting started. At that time anyone with a \$10 bill—or less—could receive radio broadcast programs simply by either buying a crystal detector and a pair of headphones, or by making the detector himself and buying the phones. From such small beginnings broadcasting began.

A little later the radio tube came into its own and then with one- or two-tube sets which gave better selectivity, stronger and clearer reception, broadcasting marched on its triumphant way. Still later loudspeakers were added. Millions of enthusiasts in the United States now were building their own sets, and the radio age was here to stay. Soon—with tens of millions of listeners getting programs—the advertised products via the radio waves paid handsomely for the broadcast effort.

Now let us turn to television. The situation here is far from parallel. To begin with, television must in its very nature be broadcast on higher frequencies (low wave lengths). That means that the reception range cannot be greater than an average of 25 to 30 miles from the transmitter. Now then, if the entire country is to be blanketed with television, this requires thousands of television transmitters. The capital outlay, therefore, for the television broadcast industry will be immeasurably greater than was the case with the broadcast industry. At the present time we only have a handful of television transmitters in this country, in actual numbers only six stations, now operating on a schedule, plus three *experimental* stations.

Against this the radio broadcast industry has 1003 transmitters as of December 1945. Even if we soon had a like number of television transmitters in the U.S., they would by no means blanket the entire country to support an advertising-sponsored television program that could conceivably pay out. To cover the entire nation with television trans-

(Continued on page 853)

# RADIO-ELECTRONICS

## Items Interesting

**TELEVISION PICKUP** relay apparatus capable of relaying signals from the pickup point to a television transmitter within a 15-mile range, was announced last month by the Radio Corporation of America.

This new radio relay equipment produces a frequency-modulated signal with approximately 100 milliwatts of power for the picture carrier. The band width permits reproduction of the finest detail in the camera picture. It operates at any selected frequency in the 6500 to 7050-megacycle band.

The use of a highly directional parabolic transmitting antenna provides a signal gain of about 5000 times, with a 4-foot reflector, or 11,500 times with a 6-foot reflector, thereby providing an equivalent power of 500 or 1150 watts, depending on reflector size, in the direction of the receiving antenna. To obtain this high gain, a hook-shaped wave guide literally pours power into the focal point of the saucer-like reflector, much as the filament in an automobile headlight sends its light to a concave reflector for intensification. The same principle is employed at the receiver unit, where the parabolic reflector receives the signal and concentrates the beam into a wave guide to add another gain of 5,000 or 11,500 times. The total effective signal gain from the transmitter waveguide to the receiver waveguide is therefore approximately 25,000,000 times with the smaller reflector or 132,250,000 times with the larger one.

The control unit of the microwave receiver, which is usually located at some distance from the antenna, is mounted in a small carrying case containing the remainder of the receiver stages, the video unit, and automatic frequency-control amplifier, and a master meter, as well as other adjustment controls.

The transmitter control unit is also built into a carrying case. It contains all the necessary operating and monitoring controls, plus a regulated power supply for transmission. Either of these control units can be removed from its carrying case and mounted in a rack for permanent installations.

**WIDE-BAND** amplification will take on a new meaning, as a result of a new tube announced last month by Bell Telephone Laboratories.

Conservative figures for the tube show a power gain of 10,000 times over a band width of 800 megacycles. By comparison the present pentode tube can give a power gain of only 10 times over a band width of 20 megacycles, and a velocity-modulation tube, operating in the microwave range, gives the same amplification over a band width of 10 megacycles.

The tube is remarkably simple. It is a little more than a foot long and only a few inches across.

It does not even look much like an ordinary tube for it has a narrow, glass stem about a foot long, flaring into a bulb on one end.

Inside the stem, a long coil of thin wire, or helix, runs from one end to the other. The wave which is to be am-

plified is fed onto the coil at the bulb end through a wave-guide and then drawn off at the other end in the same way.

The wave travels along the coil at the speed of light but because it follows the winding, it moves along the length of the tube at only a thirteenth of this speed. Meanwhile, from the bulb—actually, an electron gun—a beam of electrons is shot through the inside of the coil down the stem in the same direction the wave is moving and at approximately the same speed, i.e., one-thirteenth the speed of light.

The speeds are not exactly matched, however, and on the average the electrons go faster than the wave. They tend to slow down, though, and in so doing, they give up some of their energy to the wave. As a result the wave gains a tremendous amount of energy and becomes many times amplified.

Preliminary tests indicate the tube may amplify dozens of full color or black and white television programs simultaneously—should anyone want to send that many at once. Or it might theoretically handle more than 10,000 simultaneous cross-country telephone conversations or over a hundred million words a minute by telegraph!



The new tube which can handle 10,000 phone conversations at once. Left—Television pickup and relay set, with its recurving waveguide.



# MONTHLY REVIEW

## to the Technician

### ITEMS OF THE RADIO MONTH

"Television is getting off on the wrong foot because the screen on receivers is wider than it is high," says James T. Mangan, industrial designer and public relations expert. "This shape (foolishly copied after the shape of the movie theater screen) necessitates a small image and makes impractical the televising of dancing acts and other features requiring full-length views.

"Before the television industry goes much farther," said Mangan, "someone ought to be brave and different enough to experiment with an image and a screen that is about one-third higher than it is wide. Television must be an art by itself and shouldn't try to copy or use the movies in any way!"

New trend in servicing may be marked by the recent establishment by *Hallicrafters* of six service centers for the checking, repairing and servicing of their amateur, home, aircraft and marine radio equipment.

Set up at strategic points with a complete stock of parts for replacement, the centers will be manned by personnel selected for their ability and experience in the servicing of Hallicrafters' radios.

Milwaukee reports its first postwar ham meeting. About 325 hams—members and friends of the Milwaukee Radio Amateurs' Club—participated. Numbers of amateurs from Iowa and Minnesota, as well as Wisconsin hams, were present, and there were visitors from Illinois, Michigan, and even two hams from California. The meeting was addressed by Cy Read of the Hallicrafters.

Tests made by Bendix on the lines of the B. & O. Railroad prove v.h.f. communication practical in tunnels. A special system which includes antennas at the tunnel mouths and a single wire running through it, produces loud signals.

Largest television audience at the Louis-Conn fight was at Princeton, N. J., where 3000 saw the fight projected on a 16 x 22-foot screen. The exhibition was put on by RCA Laboratories, using a 60,000-volt kinescope.

Facsimile transmission from ground to plane was demonstrated last month by Finch Telecommunications of New York City.

A battery for use with lifeboat and life raft transmitters, developed during the war, employs ordinary sea-water as the electrolyte.

**POLICING PLANS** to minimize interference and confusion in the greatly expanded postwar radio spectrum went into effect July first, states the FCC.

Wartime technological developments have increased the usable spectrum space from a prewar limit of 300,000 kilocycles to 30,000,000 kilocycles and beyond. Hundreds of thousands of additional channels will be licensed in this added space to augment existing radio services and to introduce many new ones. Despite the vast new spectrum space available, the demand for radio channels still far exceeds the supply, making efficient policing of paramount importance.

When the federal government began policing the spectrum in 1911, after the passage of the first radio legislation, it was concerned only with a few ocean-going steamers. Today, the government, through the FCC, is confronted with the problem of preventing traffic snarls or law violation on radio highways which were not even imagined before the war.

"PIRATE AMERICANS" have drawn up plans for a commercial radio invasion of England, the *London Sunday People* charged last month.

The paper states that regular broadcasts are planned by a string of stations on the Continent and in Iceland. These would be supplemented by powerful broadcast stations on ships moored just outside British territorial waters.

Purpose of the "invasion" is, of course, to profit from the rich harvest of advertising expected on these broadcasts. Advertising is not accepted by the BBC, but British manufacturers and distributors found such advertising—over Radio Luxembourg—very profitable in the period just before the war.

The rumors were important enough to be discussed in Parliament, where a government hint that outside commercial broadcasters might be subjected to "jamming" was fiercely attacked by Winston Churchill, who charged that the citizens' "right to listen" was being threatened.

**RADIO SURPLUS SALES** are being handled in a "scandalous" manner, Senator Wiley of Wisconsin charged last month in a letter to Representative Slaughter, head of the House Committee now investigating war surplus disposal.

Senator Wiley pointed particularly to sales of \$200,000,000 worth of electrical equipment, from \$400,000,000 worth declared surplus. Radio, radar and communications equipment are included in this surplus material.

He said priority claimants, such as veterans and schools, had obtained supplies to the value of only \$2,120,000, "while private, commercial sources got \$198,000,000 worth."

Veterans and schools and colleges, despite priority rights, said Mr. Wiley, "are being intentionally ignored by WAA (War Assets Administration)," although they desperately need equipment. He estimated that "at the most" veterans obtained \$50,000 worth and schools and colleges another \$50,000 worth out of the total of \$200,000,000 that has been sold.

### RADIO COMMUNICATION

growth has increased, due to wartime technological developments, to such an extent that some believe the art has been pushed forward a whole generation, the Federal Communications Commission reported last month. Expected increases in radio services are illustrated graphically in the accompanying chart. In tabular form, they are:

Standard broadcast stations, from 1000 to 1400.

Frequency modulation (FM) stations from 50 to 3000.

Television stations from six to 200 or 300.

Radio-equipped planes from 3000 to 50,000.

Aviation ground stations from 700 to 2500.

Two-way service for autos, taxicabs, etc., from one city to 200 cities.

Radio-equipped railroads from one road to 150.

Fire department radio from no cities to 5000.

Citizens walkie-talkie from none to 200,000.

Amateur operators from 60,000 to 100,000.

In addition there will be thousands of channels for radar, for point-to-point communication, for diathermy and many other safety and special services.

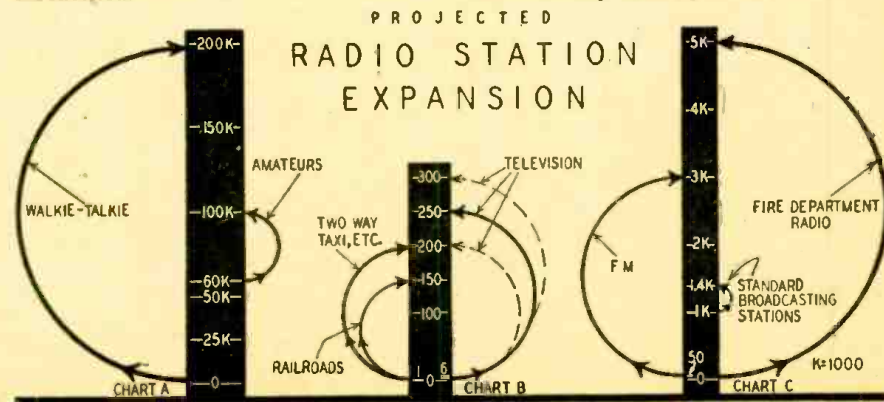

# ATOM BOMB OVER BIKINI

## A Radioman's Eye-Witness Story of the Great Experiment

**S**EVENTY million dollars worth of time, energy, equipment and incidental expenses literally went up in a blaze of glory—and light and color—when the fourth atomic bomb to be dropped in the history of the world was unloaded on a phantom fleet of seventy-seven ships at anchor in Bikini Lagoon. From the standpoint of scientific advance it was money well



Radars used in gathering atomic test data, on the island of Aemende, Bikini Atoll, spent. While \$70,000,000 seems like a lot, actually it comes down to fifty cents for every person in the United States—surely a small price to pay for a ticket on Peace, the possible winner in the World Sweepstakes.

No one—not even the scientists—quite knew what to expect as direct and in-

direct results of the tests. Comic strip writers injected Bikini into their adventure strips and predicted all sorts of things. Human guinea pigs volunteered for the privilege of being aboard the target ship, but were turned down by the Navy for obvious reasons. Publicity-mad scientists and pseudo-scientists predicted that

all the observers of the tests were doomed to die at Bikini.

In short, everybody and his brother rushed in to predict what not even the scientists who actually worked on the bomb were ready or able to comment on.

The Navy found it necessary to create the position of *staff phenomenologist*. A top scientist from the Army's Manhattan Engineer District was chosen to fill this job. His duty was to *scientifically venture* to predict what has never happened before and what was likely to happen during this test, the first of its kind over water. In the course of preparing for the Bikini tests, his estimates were revised from time to time. For example, at first it was believed that the

burst would blow a hole in the water of the lagoon approximately 150 feet deep and 500 to 600 feet across, and that the water falling back into this hole would force itself into the air in a column—a gigantic water spout four or five miles high. The original estimate had to be revised when in scale tests

Elliott A. Witten, RADIO-CRAFT's special correspondent at the Bikini atom-bomb test, is well known to our readers as a former Technical Editor of the magazine and author of a number of articles, chiefly on problems of the ex-GI and serviceman. He was also the author of the article "Radio and the Atom Tests" which appeared in the July issue.

Like many another radioman, he came up by the servicing road, having been a radio repairman no less than seven of his twenty-five years. Joining the Army in 1942, he was given specialized radio training at New York University and the Universities of Iowa and Wyoming, later acting as instructor and radar operator. Invalided out of the Army after combat service in the Air Forces, he worked as technician in a New York war plant, later as radio writer and editor.

Is now a free-lance writer. Hobbies: Instructing radio classes in the Civil Air Patrol; painting.



Joint Army-Navy Task Force One Photos

Mother plane in background turns after releasing drone, in rehearsal for Bikini bomb tests.

with small TNT bombs, only a slight depression was made in the surface.

The oceanography section of the technical staff started with a wave motion unit, added oceanographic surveys, and later radiological safety reconnaissance, which was discussed in the first article in the July issue of RADIO-CRAFT. The measurement of wave motion is the first phase of the oceanographic program. In this respect, the atomic bomb is a wonderful oceanographic fool. Knowing the point of release of the bomb, its time and the amount of energy released, the oceanographers were able to make exact measurements of the height of waves, their action in shallow water, their effect on the sea bottom, and their eroding effect on the beaches, in terms of both time and distance. Instruments for the measurement of wave motion fall into three general categories as follows: supersonic echo sounders, aerial photography, and surface photography. In addition, there were maximum water height recorders on Bikini Island and water level meters on several of the other islands of the atoll.

The supersonic echo sounders or fathometers recorded the larger waves while eleven supersonic sounders on buoys recorded the passage of the short-

(Continued on page 872)

# V.H.F. RECEIVER

## This 144-148 Mc Set Has an Interesting Tuning Unit

INTEREST in very high frequencies has resulted in a demand for a good, modern receiver for the very short waves. Some of this demand has been supplied by modified war surplus gear. The v.h.f. war surplus receivers are a bargain to the experienced radio man who can alter them to suit his purposes. For the beginner and probably for the average experimenter and ham the superregenerative receiver would still seem to be the best bet.

This receiver is easily built, the circuit is simple, the total cash outlay (even if all new parts are used) is nominal and its performance is very satisfactory.

The circuit is the self-quenched

A relatively new tuning system—the butterfly tuning capacitor—is used. This provides practically linear tuning and completely eliminates the noise from the moving rotor. A manufactured type would have been used but none were available at the time. Cardwell has advertised two units, one having a range of 11 to 14  $\mu\text{f}$  and the other of 6 to 11  $\mu\text{f}$ . If the reader prefers a ready-made part we recommend the smaller size. It will provide better Q at the frequencies desired.

A 6SF5 was used in the first audio stage. Greater gain is thus realized even if the plate voltage supply is low. A 6K6 was used in the output section. Plate and screen connections are

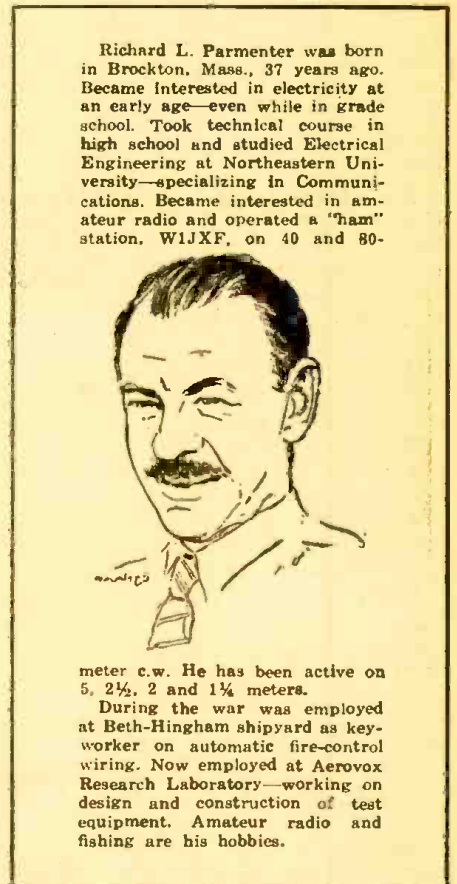

Richard L. Parmenter was born in Brockton, Mass., 37 years ago. Became interested in electricity at an early age—even while in grade school. Took technical course in high school and studied Electrical Engineering at Northeastern University—specializing in Communications. Became interested in amateur radio and operated a "ham" station, W1JXF, on 40 and 80-

meter c.w. He has been active on 5, 2½, 2 and 1¼ meters.

During the war was employed at Beth-Hingham shipyard as key-worker on automatic fire-control wiring. Now employed at Aerovox Research Laboratory—working on design and construction of test equipment. Amateur radio and fishing are his hobbies.

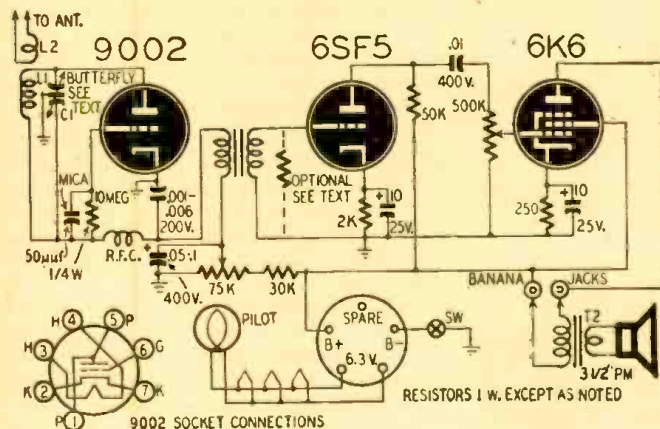

Fig. 1—Except for the butterfly-tuned superregenerative detector the circuit is a plain three-tube s.w. radio.

superregenerator. A 9002 tube is used for the detector. It mounts in a "button" type miniature socket whose contacts are very secure as compared to some types of new sockets. A base connection plan is shown on the circuit diagram (Fig. 1).

brought out to two banana jacks on the rear of the chassis for speaker connection. The switch (SW) is for standby.

### SIMPLE CONSTRUCTION JOB

Construction of this receiver is not difficult. A 7 x 10 inch chassis was used. This allows plenty of room to add an

r.f. stage later if desired. This extra space also permits placing the audio section at some distance from the detector. No dimensions are given for actual layout of parts since the photos show approximate locations.

The panel is a piece of masonite 6 inches high by 11 inches long. Holes for  
(Continued on page 866)

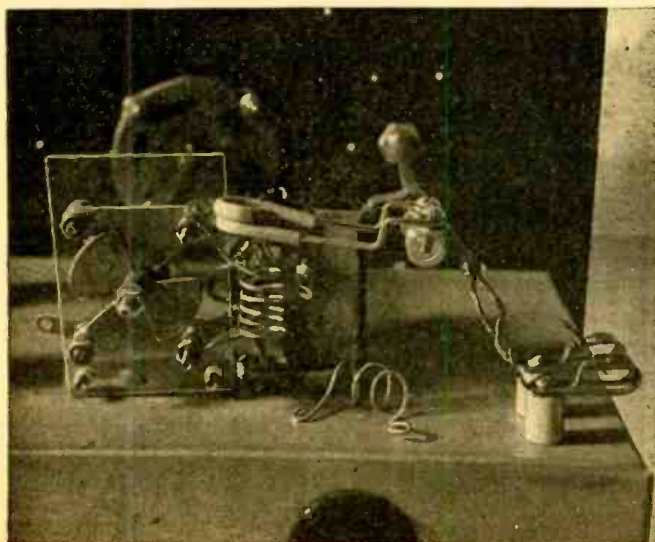

Left—Rear view of the receiver, showing the antenna-coupling link. Below—A front view. Note the boundaries of the 144-148 mc band.

# BLACK-LIGHT TELESCOPE

## New Infra-Red Tube Permits Sight in Total Darkness

SEVERAL animals are popularly accredited with the ability of night vision. Such sight is dependent solely upon a faster eye lens and they are helpless in the complete absence of light. Man now truly possesses clear vision in *total darkness*.

Such vision is made possible by an electron-image tube designated the 1P25, which was manufactured in large quantities during the war by the Farnsworth Television & Radio Corporation and others. Instruments based upon the tube were extensively employed in wartime activities, particularly in the Pacific Theatre. They assisted all manner of nocturnal activities, such as night driving, shooting, reconnaissance in air-borne, land and naval operations.

Operating on the principle of infra-red detection, they were used in conjunction with infra-red searchlights, large and small—even with flashlights!

Light of weight and small in size,

\*Research Dept., Farnsworth Television and Radio Corp., Fort Wayne, Indiana.

they were attached to the service helmet much as a miner's lamp, giving complete hand freedom while observing the objective through the eyepiece. This model was used by pilots of aircraft and made possible night driving at speeds up to 40 m.p.h. with infra-red filtered headlamps; greater speeds with more powerful lamps.

Properly dubbed the "sniperscope," a smaller type was mounted in sighting position on rifles. Closely resembling a telescopic sight in appearance, it formed gunsights, making possible hits on a target the size of a man at seventy-five yards in total darkness—a very formidable device for night fighting.

A third model, the "snooperscope," is an instrument intended for hand operation in general use and reconnaissance. A small battery-powered infra-red searchlight is mounted below the telescope or pickup device, the entire assembly attached to a pistol-grip handle. Illustrating ease of operation, one typical general purpose instrument weighs but seven pounds, including battery and

power supply, and is readily held in one hand.

Extensive use of these infra-red telescopes applies also to signaling, to night landing of aircraft, to assembly of paratroopers after landing and to all operations demanding that black-out conditions prevail.

The image tube—the essential element in infra-red electron telescopes—converts an invisible infra-red image into a visible image. It consists of a semi-transparent photo-cathode sensitive to the infra-red radiation, an electrostatic electron lens system and a fluorescent screen. An infra-red image on the photo-cathode causes electrons to be released in conformity with the image. These electrons are accelerated and focussed by the electron optical system, shown in the figure, onto the fluorescent screen where a visible reproduction of the original image is formed.

Response of the photo-cathode is confined to between 8000 and 10,000 angstrom units, the limit of human eye response being approximately 6750 angstrom units. Therefore, the subject under observation is wholly unaware of his vulnerability.

Alkali metals form the basis of all known best emitters, long wavelength response increasing with atomic weight. Therefore, caesium is used for a surface of high infra-red sensitivity.

In processing the cathode, a layer of silver so thin as to readily transmit light is evaporated on the inside glass surface. The amount of silver deposited is, in fact, determined by its light transmission. The silver surface is partially oxidized and exposed to caesium vapor, then subjected to thermal treatment. Caesium reacts with the silver oxide to form caesium oxide and free silver. The final surface then consists of silver, a layer of mixed silver and caesium oxide with metallic silver interspersed in it, and a bound layer of caesium.

The 1P25 tube, as shown in the figure, contains a four-element electron lens assembly, the final anode operating at 4100 volts; operation, in principle, is similar to that of the cathode-ray tube, electron microscope and other electrostatically-focused devices.

A fairly large class of materials, termed phosphors, become luminous when bombarded with particles or radiation. The materials within this class which can be excited by electron bombardment are useful as fluorescent screens in image tubes.

In view of several desirable screen requirements, such as high efficiency at

(Continued on page 884)

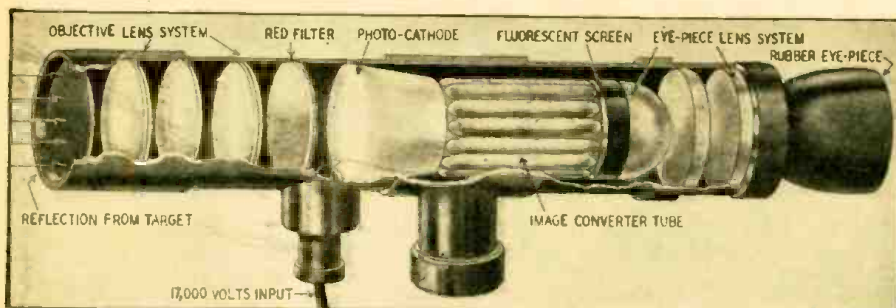

This captured German night-sight telescope worked with the aid of an infra-red image tube.

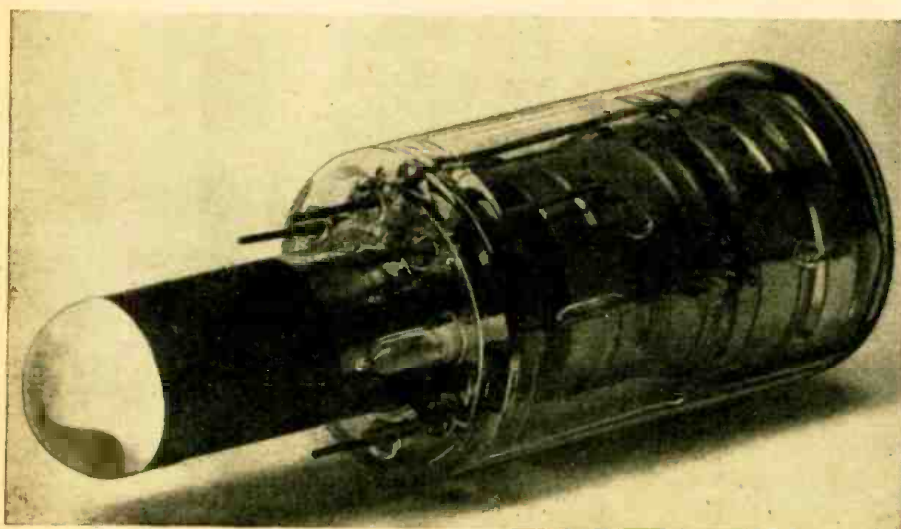

The Farnsworth and RCA 1P25 image tube, heart of Sniperscope and Snooperscope equipment.

# AUDIO RESPONSE CORRECTION

## Compensation Circuits for Phonograph Record Amplifiers

THE average magnetic pickup should be followed by some equalizing circuit for two or three of the following reasons:

1—The lower frequency (bass) notes are attenuated in most recordings, usually at a rate of from 3 to 6 db per octave below some frequency called the "change-over frequency." The rate of attenuation is usually 6 db per octave because such a rate corresponds to "constant amplitude" recording.

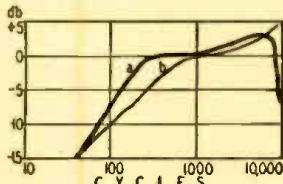

Fig. 1—American and English record curves.

2—In some recording systems the higher frequency notes are given a slight boost—there may be a gradual rise of about 1 db per 1000 cycles above about 1500 cycles or there may be a broad peak around the 4000 to 8000 mark.

3—Any pickup contains two resonant frequencies; the lower or bass resonance due to the pickup head vibrating to and fro and the upper or needle resonance due to the armature vibrating against the needle-tip (needles are not perfectly rigid).

The lower resonance is sometimes used—especially in cheap pickups—to partially compensate for the bass cut in recording, but the upper resonance is just plain nuisance as it occurs at a very audible frequency and is excited to a large degree by surface irregularities in the record.

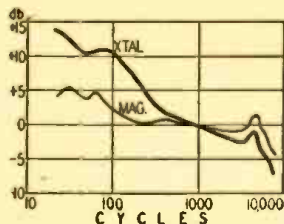

Fig. 2—Crystal and magnetic pickup response.

Scratch and surface noise occurs at all frequencies, high and low, but mostly around the resonant frequencies.

A pickup filter is necessary then for three reasons: To compensate for lack of bass, to reduce excessive high-frequency response and to reduce the response around the resonant frequencies. In Fig. 1, the frequency char-

acteristics of various records are shown. That labelled *a* corresponds to a large number of English records and that labelled *b* applies to many American discs. However, individual discs vary. It will be noticed that the crossover frequency is generally lower for the English records while these also have a more pronounced rise in the "lower highs." Generally speaking, American discs have more upper highs and less bass than the English records. The different frequency characteristics require different compensation circuits.

In Fig. 2, the frequency responses of a typical good-quality magnetic pickup and an average crystal pick-up are shown. It will be noticed that while in both cases there is a peak at about 4500 cycles, because both employ steel needles, the crystal pickup has a rising bass characteristic in addition to bass resonance.

### OVERALL RESPONSE

Now suppose we combine the four graphs so far presented and see what we get.

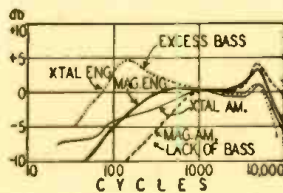

Fig. 3—Combination of the previous graphs.

In Fig. 3, the rising bass of the crystal pickup gives just about the correct bass response to the American disc while the bass resonance of the magnetic pickup provides almost enough compensation for the lesser bass cut of the English records. Possibly this is why cheaper American radio-phonograph combinations almost invariably use crystal pickups while most English "radiograms" employ magnetic pickups. (It should be noted that the vertical scale of these graphs has been greatly exaggerated.)

The high frequency end of the graph is still to be considered. High frequency attenuation is usually obtained in the amplifier by means of a shunt condenser.

Overall frequency characteristics do not tell the whole story. Although a resonance peak may be levelled out, there is still no compensation for the longer time a note (recorded or "scratch") is played if it occurs at that resonant frequency. When a sound is heard for a fairly short time, its audibility is largely proportional to the

product of its intensity and its duration, so a partial compensation for excessive duration can be achieved by over-reduction in response at the peaks.

In designing correction filters, it is necessary to know just what is being aimed at, otherwise the filter is apt to be a flop. A simple but correctly designed filter consisting of only two or three elements can easily give results superior to those from an elaborate but badly designed one.

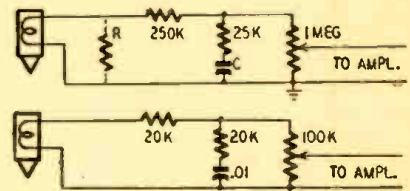

Fig. 4—Circuits used for boosting the bass.

### POSITION OF FILTER

The position of a filter affects its action. If connected directly after the pick-up, reactive elements in the pick-up must be considered. If connected after the first tube, the type of tube must be taken into account. In simpler amplifiers, some compensation can be left until the output stage.

Three main types of correction circuits will be considered:

1—Resistance-capacity circuits (these are probably the most interesting to the amplifier enthusiast and the easiest to build).

2—Tuned circuits, including acceptor (series) and rejector (parallel) circuits.

3—Circuits in which compensation is made by varying the amount of negative feedback.

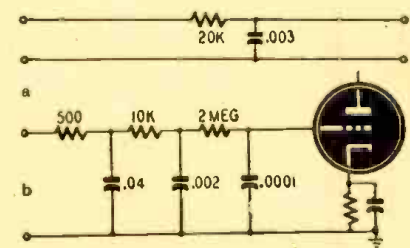

Fig. 5—Two circuits for cutting the highs.

No account is given of low-pass or band-pass circuits because—although restriction of unnecessary frequency response is sometimes helpful in eliminating background noise and in scratch reduction—the circuits are difficult to adjust and not at all suitable for the average amplifier enthusiast.

(Continued on page 877)

# ARMY-AMATEUR RADIO CLUB

## Signal Corps Ham Organization at Fort Monmouth, N. J.

**F**ORT MONMOUTH, New Jersey, world renowned as "the home of the Signal Corps" is making a new claim to fame. The idea of having the world's outstanding amateur radio station at Fort Monmouth was conceived in the mind of Colonel Brooke E. Sawyer, W6CV, (now Mr. Brooke E. Sawyer of Redlands, California). Already The Fort Monmouth Radio Club has been organized, chartered, and is operating under the call W2OEC in an effort to earn the reputation envisioned by Col. Sawyer. The trustee and secretary of the club, Major John M. Moss,

W2OEC (formerly of Moss Radio Company, Russellville, Arkansas) obtained FCC approval of the club charter and the station license. The club charter, patterned on the American Radio Relay League model charter, was adopted by the members of the club on April 10, 1946.

The club will primarily serve the enlisted, officer and civilian personnel stationed in the Signal Corps schools and laboratories. It is expected that many messages to and from military and civilian personnel on overseas duty will be handled. Round-the-clock

operating schedules will be maintained with amateur stations all over the world to relay routine amateur traffic, as well as emergency messages. The Field Director of the American Red Cross at Fort Monmouth will keep in close touch with the club so that certain emergency messages may be transferred to usual commercial facilities by the Red Cross. Code and theory classes will be conducted by the club to assist members in obtaining amateur radio licenses.

Due to the concentration of Signal Corps personnel as well as the presence of a number of commercial radio research laboratories, the area has an unprecedented concentration of hams and ex-hams, many of whom are divorced from their own means of communication. The officers of the Club have calls from the First, Second, Third, Fourth and Eighth Districts, and there is an equal spread of calls in the membership. Indeed, there are rumors of a new over-the-air club, composed of amateurs who have worked all United States districts within Monmouth County, New Jersey.

A wide assortment of communications gear has been obtained by the club and it is planned that a one-kilowatt transmitter will be maintained on each of the amateur bands below 30 megacycles. The equipment now installed includes four radio transmitters BC-610 (major component of the famed SCR-299 and SCR-399), two radio transmitters BC-452 and one radio transmitter BC-339. See Figs. 1 and 2 for block diagrams of the BC-610 and BC-339 transmitters. The BC-452 transmitter consists of an 837 crystal oscillator, 807 buffer stage, and a pair of 813's in push-pull as the final radio frequency amplifier modulated by a pair of 805's.

A ten-meter rotatable horizontal beam antenna built by Cpl. Jack D. Rodebaugh, W8L10 (formerly of Brush Development Company) has been erected on a fifty-foot pole. This beam antenna consists of a single fed element, and two stacked untuned reflectors, as shown in Fig. 3. The excited element is fed by a 72-ohm coaxial cable. Two eighty-foot poles were obtained for mounting the eighty-meter folded dipole antenna of Fig. 4. When the holes for the eighty-foot poles were being dug water was struck at a depth of four feet, consequently six-foot concrete aprons had to be built around the base of each pole. Additional guys were required to give adequate support to the poles, which

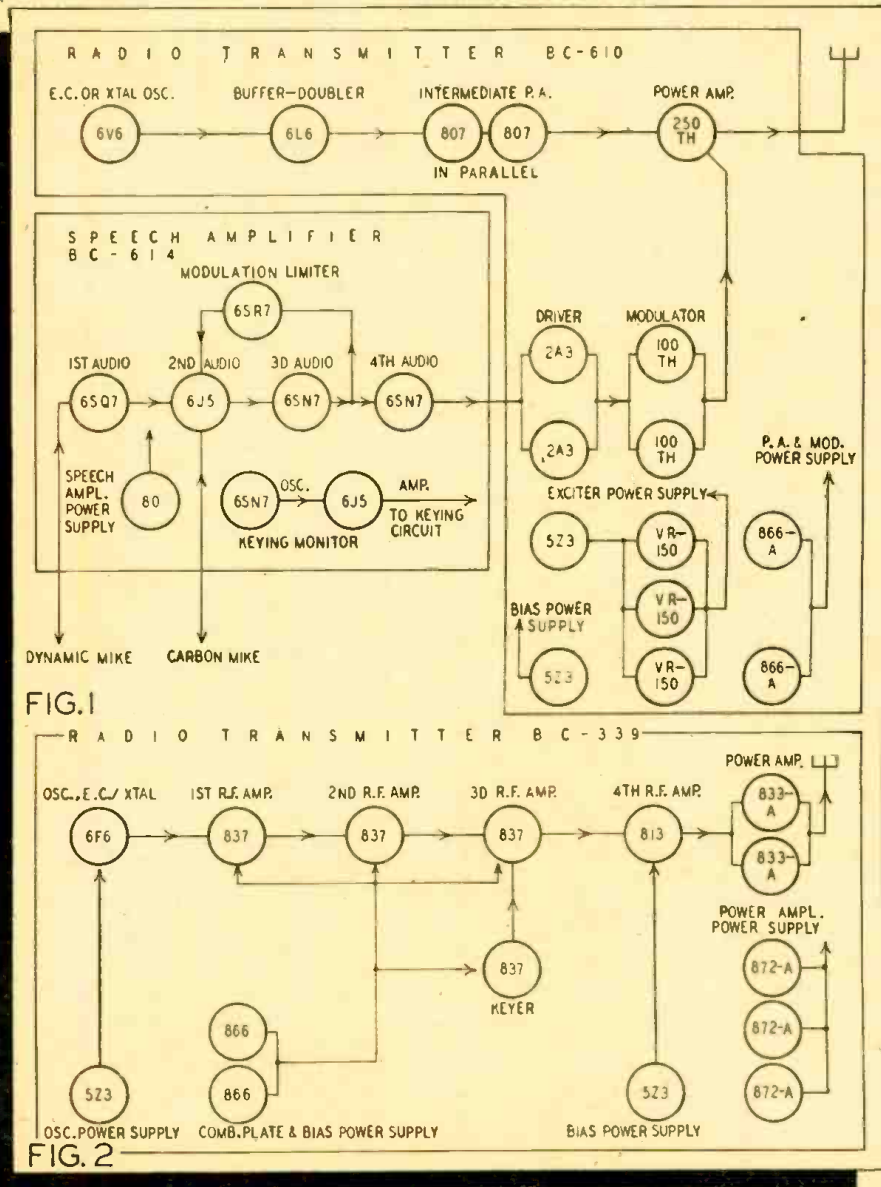
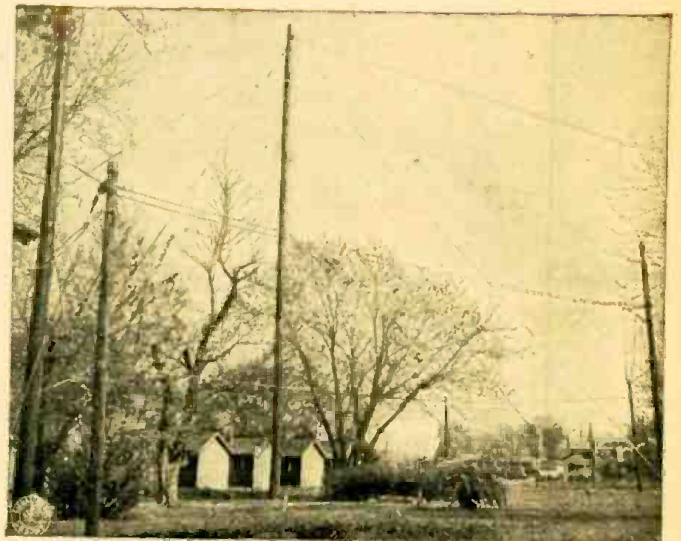

Fig. 1, above and Fig. 2, below—Block diagrams of the BC-610 and the BC-339 transmitters, first to be installed in the new club.



An interior view of the ham shack. Adjustments are being made on the BC-610, which was actually on the air as the photo was taken.



Part of the 80-meter folded dipole antenna, with the transmission line which is brought in on telephone poles to the shack at left.

now extend approximately 76 feet above the ground. This 80-meter antenna is oriented so that its directivity centers on the middle of Missouri. It is expected that it will give fairly complete coverage of the United States.

At present the club has only two receivers, but more are expected shortly. A BC-1004 (Hammarlund Super-Pro) is used for the lower frequencies while a Hallicrafters Model SX-24 with a converter is used on the higher frequencies.

Building 498 at Fort Monmouth has been authorized by Colonel Hugh Mitchell (Commandant of the Eastern Signal Corps Schools) as the club headquarters. The building has two rooms, one of which will be used as a lounge for visitors and as a classroom; the other room will house the equipment and will be the operations room. Two small shelters will be used as workshops for persons who want to build their own amateur equipment. One shelter will contain equipment for drilling and punching chassis while the other will be

used for wiring and testing equipment.

As can be seen in the photos, there is already a considerable amount of equipment in the transmitting shack, and though the skids under one of the transmitters indicate that some of the material is still in the process of installation, it is expected that by the time this appears in print everything will have been "shaken down" and the Club will be operating on a regular routine.

The following is a roster of club officers:

President—Capt. Edward L. Neilsen, W4IAI.

Vice President—M/Sgt. Phillip H. Huston, W3EHB (who served in China with the Office of Strategic Service as a major).

Secretary—Major John M. Moss, the trustee of W20 EC.

Treasurer—Pfc. Francis E. LaJoie, ex-W1HXD.

Property Officer—1st Lt. E. J. Mazzi. Activities Manager—Cpl. Jack D. Rodebaugh, W8LIO.

Chief Operator—Pfc. Peter N. Borsie.

Already excellent contacts have been made with amateur radio telephone stations in California on the 80-meter band and it is expected that many GI and ex-GI amateurs will maintain contact with the Signal Corps and Fort Monmouth through W20EC. Schedules will be increased in number and operating time expanded to a full twenty-four hours daily, as soon as traffic increases sufficiently to make it practical.

The Club would like to make contacts with any similar Army-Amateur clubs throughout the United States (and elsewhere, if such exist).

Right, foreground—10-meter, background—80-meter antenna. Below, Figs. 3 and 4—Details of 10- and 80-meter antennas, respectively.

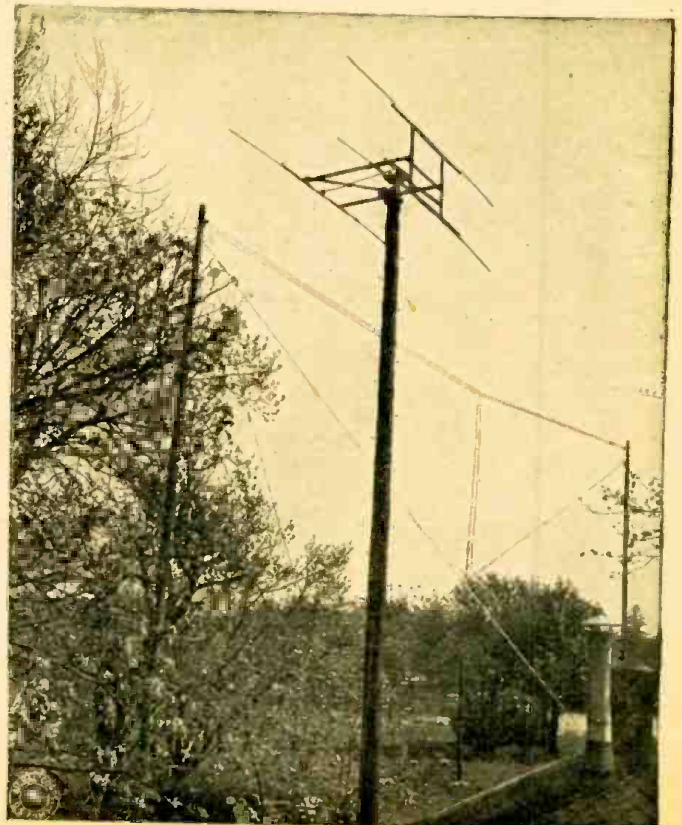
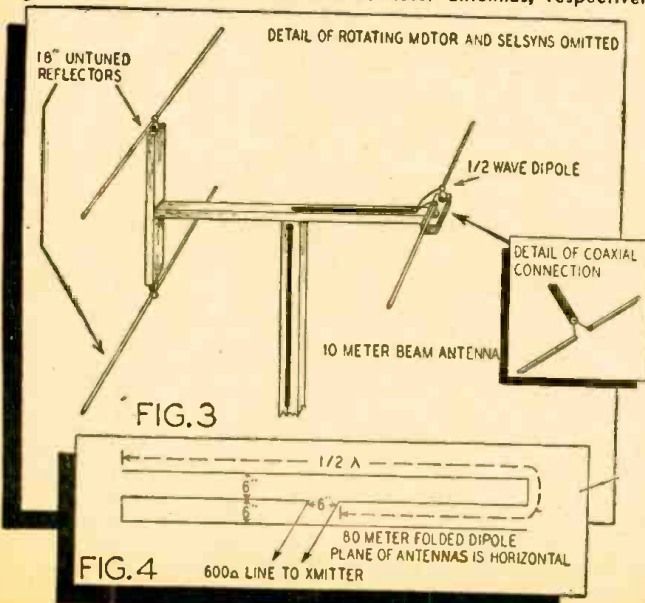

# GERMANIUM CRYSTAL PROBE

## Another Valuable Application of the Germanium Crystal

THE majority of present-day Vacuum Tube Voltmeters are essentially d.c. indicating devices. A rectifier unit is employed to permit measurement of a.c. voltages.

Many factors influence the choice of the rectifier unit and its arrangement with respect to the d.c. indicator. Since operation over a wide frequency range is desirable, it is necessary to make all a.c. leads as short as practicable. Moreover, linear rectification is preferable so the d.c. indicator deflection will be directly proportional to the magnitude of the a.c. voltage.

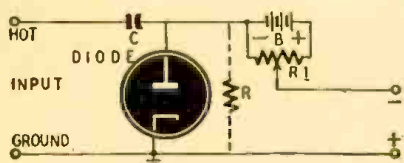

Fig. 1—Diagram of standard type diode probe.

A vacuum-tube diode rectifier, mounted in a convenient probe and arranged to feed the d.c. section by means of a shielded cable, is admirably suited to this purpose.

A wide variety of small vacuum tubes may be conveniently used. In general, it is necessary to choose tubes having a low input capacity. Thus the input impedance will be sufficiently high to preclude loading of the external circuit.

With the advent of the new Germanium crystal-diode (Sylvania 1N34), the constructor has a useful device which simplifies probe design. Most of the disadvantages of vacuum-tube diodes are eliminated.

A comparison of Figs. 1 and 2 will show immediately the simplicity of the crystal version. Fig. 1 illustrates a typical vacuum diode circuit. Fig. 2 shows its crystal counterpart. Note that a small battery and variable resistor are needed to balance out the contact potential of the diode. The properties of the Germanium crystal have been adequately described in the literature.\* Hence no attempt will be made to discuss the theory of operation. An actual probe will be described.

The probe is simple to fabricate. It was built into a small penlite flashlight case details of which may be seen in the photo, which shows its use in conjunction with radio enthusiast Russell Suthard's version of the "Electronic-Omnichecker".\*\* Note the extremely

small size. The circuit is that of Fig. 2. The capacitor C is .01  $\mu$ f and the function of R is taken over by the divider resistors across the input of the vacuum tube voltmeter. In operation the VTVM is set up to measure negative d.c. voltage. Full scale meter reading of 1.5 volts d.c. may be obtained with the circuit of Fig. 2 when 1.5 volts a.c. is applied to the probe. To increase the d.c. output voltage, the value of C must be increased. A value of .01  $\mu$ f or less is to be preferred, however, in order to keep the input impedance at a high value.

An exploded view may be seen in the second photo. The front row of this photo shows (left to right) the capacitor, C, as it is soldered to a short length of pointed No. 8 wire and the tiny crystal and its mounting. The bakelite tubing fitted into the plastic case cap and the case proper are shown in the second row. In the background of the first photo rests the 7-prong plug which feeds the d.c. indicator.

The crystal will operate well at fre-

quencies as high as 100 mc. The input



Fig. 2—A diode probe with germanium crystal.

impedance of the unit shown was found to approximate one megohm at 1000 cycles per second. The output is non-linear on the lowest range and the meter must be calibrated accordingly. A linear scale, however, is sufficiently accurate for most purposes.

It is to be emphasized that the a.c. voltage applied to the probe must be limited to somewhat less than 50 volts. To double the applicable voltage, two crystals may be used in series.

The above material is considered merely suggestive. It is hoped the experimenter will find many new uses for the crystal. Doubtless, variant circuits can be adapted to special requirements to suit the user.



The crystal probe in its small penlite case.

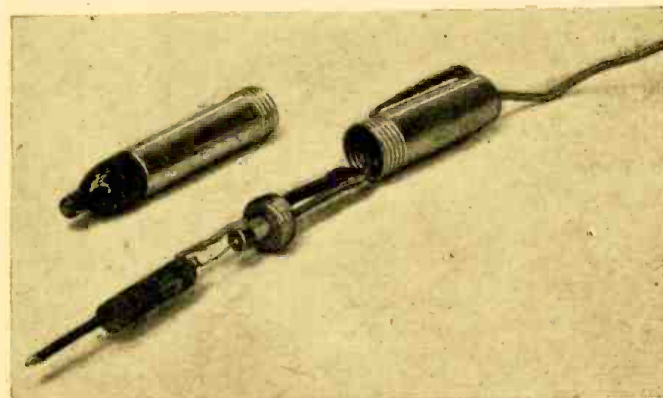

Exploded view of probe. Crystal is at center.

\* See "Germanium Crystal Diodes"—Cornelius, *Electronics*, February, 1946.  
 \*\* "H.F. Crystal Diodes"—LeDuc, *RADIO-CRAFT*, March, 1946.  
 \*\* *RADIO-CRAFT*, June and July, 1945



# LINK-COUPLED CRYSTAL SET

## A Selective Receiver with Surprising Distance Range

THE *Two Timer* is a new and different type of crystal set, and should appeal to those who have been searching for a truly dependable mineral operated receiver. Unlike the average set of its class the *Two Timer* offers extreme flexibility, a feature that

times exceeded that of local WITH! Ordinary "run-of-the-mill" DX includes WWVA, WBBM, and WGY.

All stations heard were positively identified; and, for the most part, the signals were loud enough so that the programs heard were perfectly understand-

able. The best dx "catch" to date was KOY (Phoenix, 1000 watts on 550 kc) heard while local WCAO (Baltimore, 5000 watts on 600 kc) was still on the air! There seems to be no limit to the dx possibilities of the *Two Timer*, and yet the antenna requirement of this set is such that a 100 ft inverted "L" with a 50 ft lead-in is sufficient for most

locations. A shorter antenna may be employed for purely local reception.

The "Cut-your-antenna-to-the-listening-frequency" theory was given the well known "Bronx cheer" when such long wave stations as the Altoona (Pa.) and Washington (D.C.) airport control towers were heard, along with the aircraft beam stations BO, KW, WA, and NHK; while on short wave the police stations WCK, WPDP, WPF5, and WPFH were heard; as were the International phone stations WNRX and WLWK.

Before starting the actual construction of the receiver it would be wise to make a thorough study of the schematic diagram. It should be particularly noted that the *Two Timer* consists of two separate units. They may be mounted on the same baseboard and panel, yet they are, electrically, as much separated as if they were miles apart. This means that the coils should be mounted at right angles to each other; or on a different plane to each other; and that the set should be wired in such a manner that the antenna coupler

and the detector will not be coupled by stray capacities. This is most important, because if the units are jammed together in a small space the operating efficiency will be but mediocre.

The coils L1 and L4 are exactly alike, and are wound with No. 26 enameled wire on forms 1½-inches in diameter as follows: Wind 10 turns and make a tap; from this point make taps at the following numbers of turns: 15, 20, 25, 30, 35, 40, 45, 50, 55, 60; which means a total of 11 taps and a total of 385 turns of wire. The 11th tap is the end wire on the coil. L2 and L3 are alike in that each is wound on 1½-inch diameter forms. Consisting of 30 turns (each coil) of No. 26 enameled wire, tapped at the 10th, 20th and 30th turn, these coils fit inside L1 and L4 and are joined together by a twisted-pair link-line. Any suitable wire may be used, and the length is unimportant, though it will seldom exceed 20 inches in actual practice. When the coils are completed a thin coat of Duco household cement will do much to preserve them and will keep the works from falling apart with constant use.

Band switching is accomplished by one of two methods: battery clips or tap switches. The author made his own tap switches from antique rheostats, but battery clips were used to advantage in the original experimental model. If you use switches DO NOT attempt to "lase" or bind the wires to and from the coils and switches. This might make for a neat job but was found to be detrimental to the overall efficiency of the receiver.

Assuming that the antenna and ground and earphones are connected, and that a "hot spot" has been found on the crystal, the first procedure is to  
(Continued on page 875)

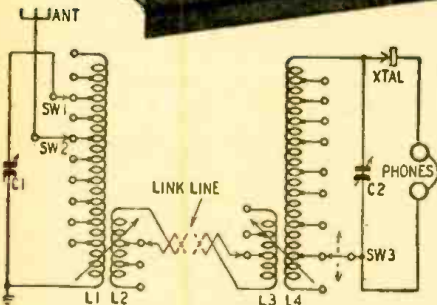
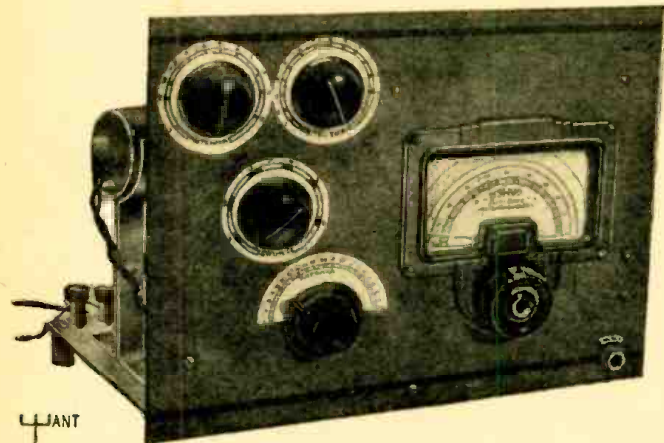

Above—The *Two Timer* from the front. Link lead extends from coil. Below—Schematic of the set. Coils L1 and L4 have 12 taps each.

is wholly responsible for its unusual bandspread and extended frequency range.

Consisting of two separate units (antenna tuner and detector) and employing link coupling, the receiver is operated much in the same manner as a one-tube regenerative set; one dial is used for tuning while the other is used as a sensitivity control.

Living just outside Baltimore (Maryland) the author has heard such stations as WGN, WOR, WABC and CBL, shortly after sunset of a winter's evening. Later in the evening it was not uncommon to log other stations like WSB, WWL, and WKBW. After our local stations sign off (excepting one, WITH, an all-night station) the dx really rolls in. . . . with XEG, CBM, CMAC and CMAQ, WIBC, and KXEL being heard regularly. WLW, WTOP, WCKY and WHAS are logged nightly. The signal strength of WLW and WHAS has at

Right—Rear view of the *Two Timer*. Twisted lead is the link coupling line.

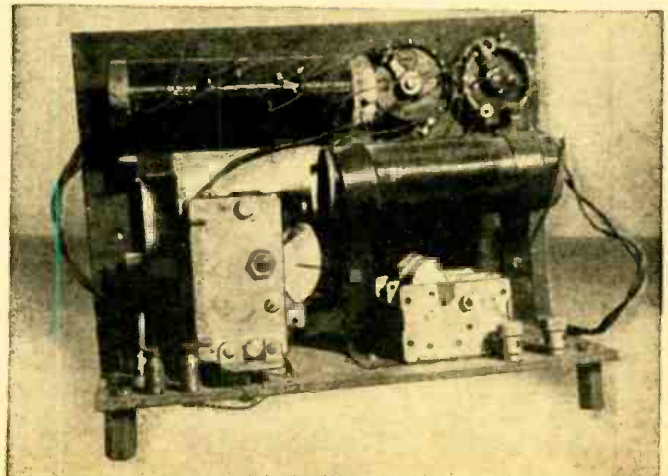

# REBUILDING A TELEVISER

## Modernizing the Pre-War Television Receivers

It will be at least a year before many new television sets can be produced. Those who now have kit-constructed television receivers may be interested in improving their sets with a few simple changes and additions.

The circuit diagram of a typical television receiver kit (Andrea KTE5) is shown in Fig. 1. Changes that have been made are shown in the circuit at the points marked with letter designations. Separate drawings show each of these changes in detail.

At "A" the original circuit was revised to include a type 6AG7 as the video output amplifier in place of the 6V6 which was used in the original circuit. In addition to base connection changes the dropping resistor in the screen circuit must be reduced to a value of 25,000 ohms, 5 watts. This change will result in an improvement in brightness and overall detail. When wired for the 6AG7 an 1852/6AC7 can be used interchangeably if the lower filament drain of the latter is preferred. Its lower transconductance will make no difference. Changes "B" and "C" are substitution of the 6SN7GT tubes for the 6F8G's used as vertical and horizontal deflection voltage amplifiers. A number of base connections must be changed. This brings all connections below the chassis. The cathode-coupled circuit shown in "D" applied to the vertical amplifier improves the vertical uniformity. This can be seen in the equalization of the lengths of the vertical wedges in the test pattern.

The change made at "E" reduces hum pickup in the vertical height control leads. It consists of shielding the lead from the plate coupling capacitor of the 6N7 vertical sweep oscillator to the picture height control, and also shielding the lead from the slider connection of this control to the grid of the first half of the 6SN7GT (or 6F8G), vertical amplifier.

Hum picked up in the video circuits is evidenced in the appearance of horizontal dark areas across the picture which may remain stationary or move slowly in the vertical direction. Another indication of hum is in the appearance of "S" shaped sides in the raster, with consequent picture distortion. This type of hum is generally the result of either hum voltage in the horizontal deflection circuits, or is picked up directly at the deflection plates from electromagnetic fields surrounding components on the chassis. A soft iron or "mu" metal pipe of suitable diameter used as a shield around the neck of the cathode ray tube will reduce the pickup from such fields. Separation of power components from

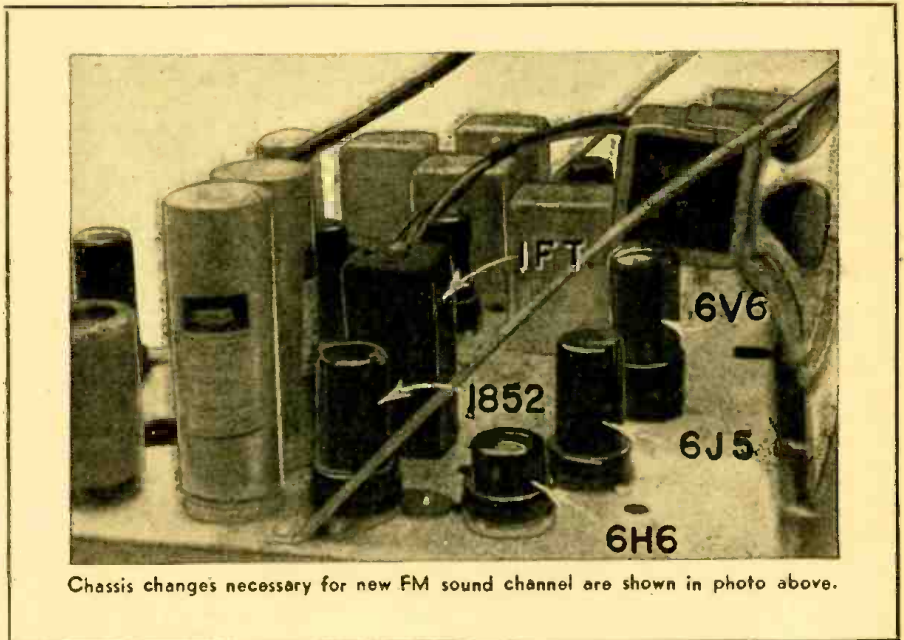

Chassis changes necessary for new FM sound channel are shown in photo above.

the chassis is desirable but impractical in this case unless a separate power supply is constructed, as described later.

At F, the insertion of additional differentiator elements as shown will give improved horizontal synchronization and prevent "tearing" of the picture by random noise, static or ignition pulses. The values indicated were satisfactory for the author's equipment. Experiment may provide better values for the reader's set. A similar addition of elements in the low-frequency (vertical) sync separator string will prevent random pulses from triggering the vertical sync out of control, resulting in the picture rolling vertically. This is shown along with circuits for horizontal sync in Fig. F.

Use of the contrast control on the author's set to lower the picture signal level or reduce contrast also brought the sound level down. This condition is eliminated by lifting the 1000-ohm cathode bias resistor in the 1852 mixer off the contrast control and grounding it. Thus the contrast control operates only on the video i.f. and cannot affect the sound level. This is illustrated at G. If the cathode bias resistor is changed from 1000 ohms to one of 250 ohms, increased signal will result in remote locations. The unby-passed 40-ohm resistor in the modulator cathode above the 1000-ohm resistor improves high frequency performance of the modulator tube. Some of us have either shorted out this resistor or by-passed it with

a .006  $\mu$ f capacitor to ground with consequent increase in signal.

The changes described above are all designed to improve the overall performance of the receiver in its present form. The balance of this article is devoted to the discussion of more ambitious changes of an experimental nature designed to make the author's set adaptable to larger tubes without necessitating further changes.

As this is being written the new channel assignments for the New York area

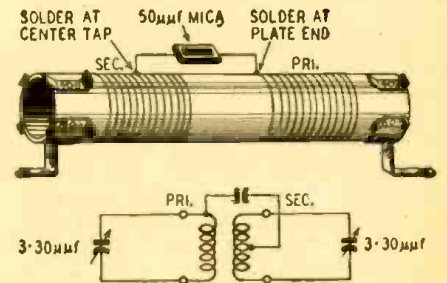

Fig. 2—How the discriminator coil is made.

are announced. They are Nos. 2, 4, 5, in the range below 100 megacycles. The removal of one full turn each on the grid and tickler of the oscillator coil, and the grid and antenna secondary winding of the antenna-input coil will make possible tuning all three channels. This appears at H in Fig. 1. A new switch will be required to accomplish the change. It will more than likely be necessary to revise some existing  
(Continued on page 879)

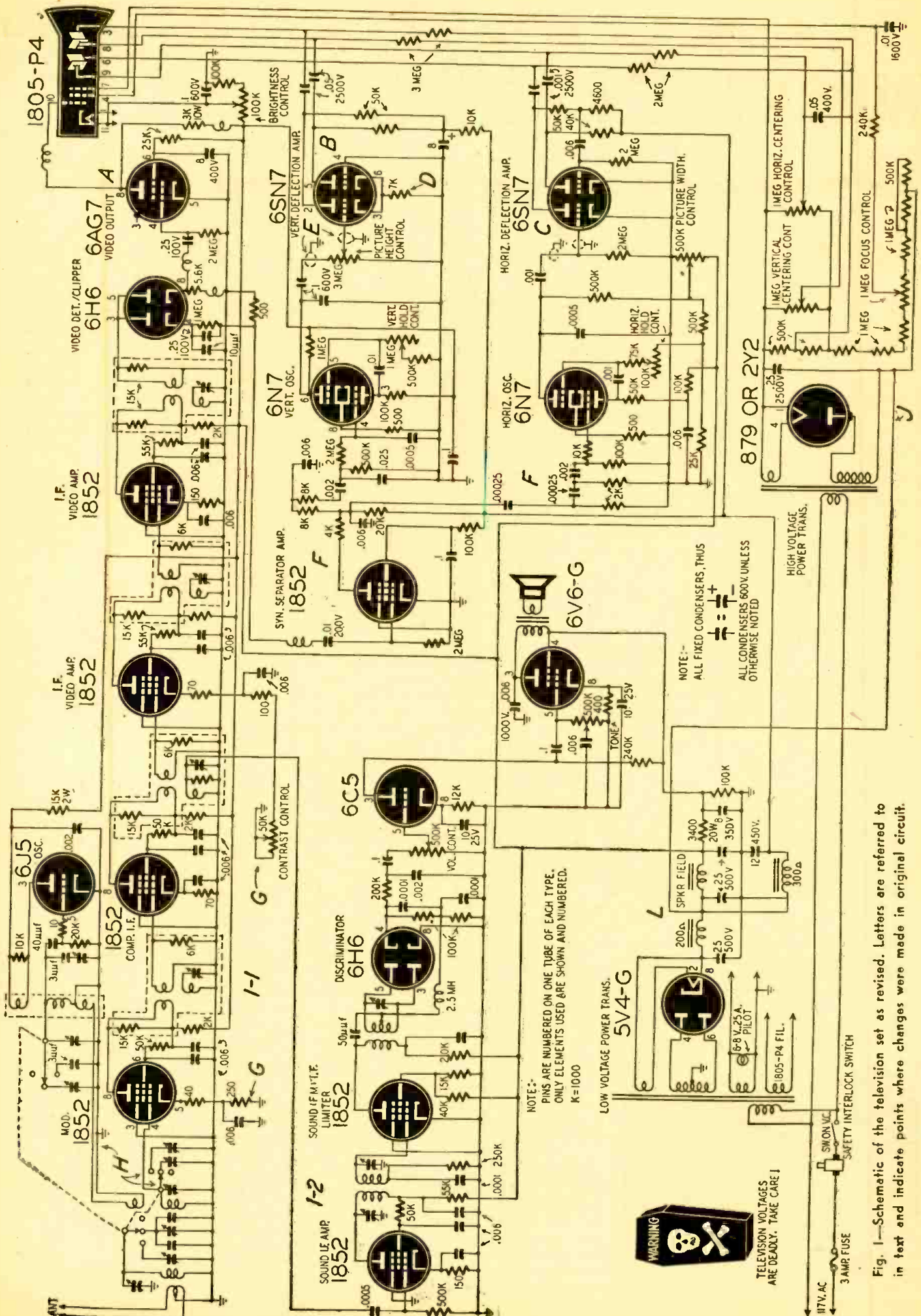

Fig. 1—Schematic of the television set as revised. Letters are referred to in text and indicate points where changes were made in original circuit.

# AUDIO MIXER DESIGN

## How These Important Devices Are Constructed and Used

**I**MPORTANT factors in the design of broadcast audio equipment are operational and structural problems presented by the audio control panel or mixing console.

Since various types of fixed and variable attenuators go to make up the greater part of audio mixing equipment it may be well to touch upon some of their more important circuit applications before discussing the conventional audio mixer.

Attenuators are essentially resistive networks, accurately calibrated to give a known *insertion loss* and designed to match the terminal impedances of associated input and output circuits between which they are used.

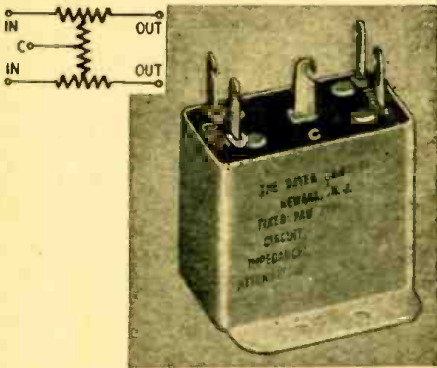

Fig. 1—Fixed attenuator (balanced-H type).

Attenuators may be divided basically into two classes, fixed, and variable. The fixed type is more often referred to as a *pad*, while the variable attenuator is commonly known as a *fader*, *pot* or *volume control*.

A fixed pad usually consists of a number of card-type resistors non-inductively wound on thin strips of bakelite and designed to give constant impedance over a wide range of frequencies. Well-designed pads have been found to maintain a constant-impedance



Another balanced-H network of lower wattage.

characteristic to frequencies beyond 10 megacycles when the terminal leads were properly shielded. A typical fixed pad is shown in Fig. 1.

Fixed pads are generally classified as either "T" or "Balanced H". There are also a number of additional types known as "Ladder", "Pi", "U", Balanced "U", "O", Balanced "O", "L", etc. These are derived from the two general types "T" and Balanced "H". Pads may be made to match any circuit impedance to another at any desired insertion loss.

Fixed pads are probably used more extensively than any other single piece of broadcast equipment. Some of their more common uses are:

- 1—As impedance transformers (for example, to match a 500-ohm output to a 600-ohm line).
- 2—To isolate each branch of a multiple-feed circuit from the program bus.
- 3—To bridge a program bus and provide a simultaneous feed to a network of monitoring speakers, at different levels if desired.
- 4—To combine multiple-channel circuits.
- 5—To allow switching of a volume indicating meter from one circuit to another of different level or impedance.
- 6—To balance the output of several monitoring speakers connected across amplifiers of different output levels.
- 7—To provide the proper amount of insertion loss in frequency response measuring equipment.
- 8—As a standard reference in comparison resistance measurements.
- 9—To provide isolation between pre-amplifiers, mixing circuits, program amplifier and transmitter, at the same time attenuating or reducing the output of each unit to the proper level to prevent overloading, distortion and cross-talk.

In a typical application, four pre-amplifiers feed into a high-level mixer. Two of them are used for microphones, the other two for turntable equipment. Output of microphones ranges approximately from -85 db to -75 db; that of the turntables is about -50 db. Since it is desirable to provide an equal level in each leg of the mixer circuit, both to maintain similarity of fader control settings and to prevent cross-talk or overloading of one mixer leg, a pad of the required insertion loss (about 30 db) and proper terminal impedance is placed in the output circuit of the turntables. It is usually connected between the pre-amplifier output circuit and the input of the fader.

Potentiometers, rheostats, ladders, "L" networks and "T" or "H" networks are the basic types of attenuation networks, the latter three types being more commonly used in mixing circuits.

From the above types of networks have sprung derivatives such as the balanced and unbalanced forms of rheostat, potentiometer, "LL", "LR", bridged "T" and bridged "H". Some of these are shown schematically in Fig. 2.

Because it cannot maintain a constant impedance at various settings the type

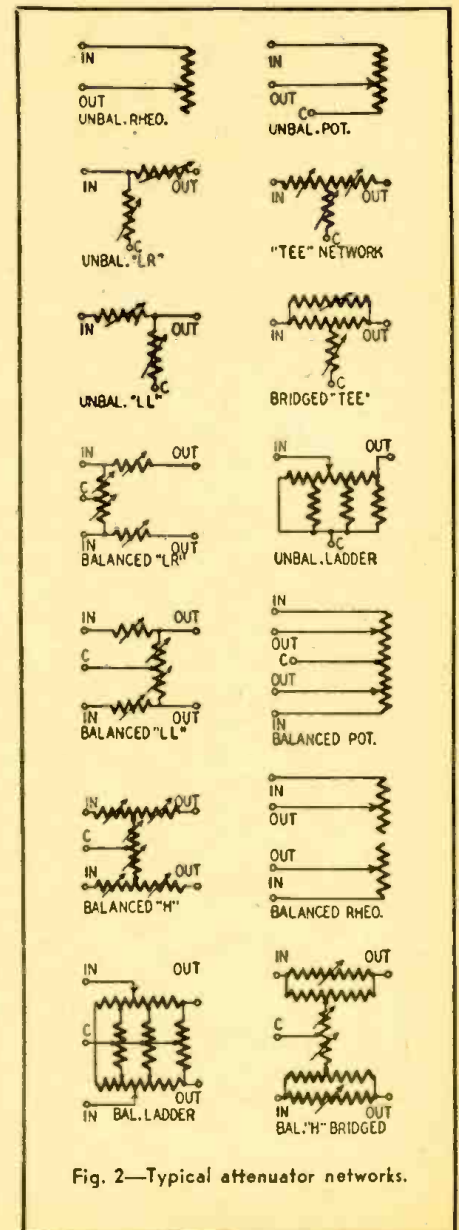

Fig. 2—Typical attenuator networks.

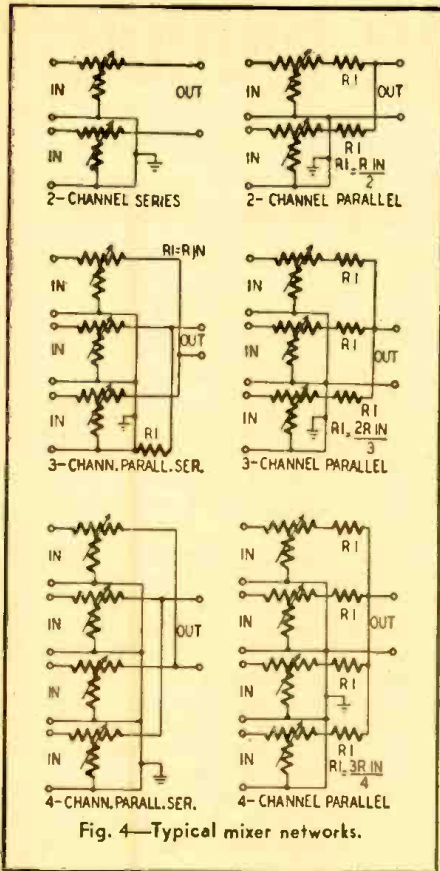

Fig. 4—Typical mixer networks.

"L" fader is used only in circuits where such variance may be tolerated or desirable. In mixer circuits and other constant-impedance networks, attenuators such as the "T", "H", and Ladder must be employed. The "T" is used in unbalanced circuits, and the type "H" fader where balance must be maintained.

The ladder-type attenuator is more commonly found in mixer circuits. Part of its popularity is due to its noiseless operation and excellent frequency characteristics. It represents a distinct advancement over the "T" and "H" types, affording a constant impedance in both input and output circuits over an attenuation range from 0 to 45 db, beyond which the attenuation gradually increases to infinity. The dial is calibrated in 1.67 db steps (Fig. 3).

The resistance elements of attenuators are composed of unifilar windings on thin bakelite strips or non-inductive wire-wound spools, either type of construction allowing production of pads capable of a noise level lower than -150 db. Contact arms are of heavy, multi-leaf construction. One set of leaf fingers makes contact with the outside resistance-contact studs while the inner set makes contact with a rotor slip-ring. The aluminum back cover is removed to allow access to the contact points for cleaning, a process which consists mainly of wiping the contact points and rings with either carbon tetrachloride or a mixture of half alcohol and half ether, and lubricating with a very small amount of Daven or fine clock oil. A small amount should be applied to the wiping arm, the arm rotated several times, and then the oil wiped off. This

action removes any dirt or other matter from between the rotor blades. A thin film of lubricant is then applied to the blades and the cover replaced.

#### HIGH VS. LOW-LEVEL MIXING

Faders are usually connected in series or series-parallel, depending on the number of channels used. They are fed to subsequent stages of amplification through a 1:1 ratio isolating transformer which has an electrostatic shield between windings and a grounded center-tap on each coil winding. The transformer eliminates cross-talk and stray noise pickup, in addition to acting as an impedance-matching coil where 50-ohm or 200-ohm faders are connected to a 500-ohm line.

Two types of mixing systems, high-level and low-level, are in use. Each has its own merits. (See Fig. 4). High-level mixing is accomplished by feeding each microphone or turntable output through a stage of pre-amplification and thence to the mixer, the action taking place at the comparatively high level of approximately -40 db. In low-level mixing, outputs of the various microphones are fed directly into a mixing circuit and thence to a pre-amplifier.

In the field, low-level mixing makes compactness possible in remote amplifier design. Only one amplifier unit need be used, instead of one for each microphone circuit. In the studio, the advantages of high-level mixing more than outweigh the slight disadvantage of increased unit cost. High-level systems have an inherent noise level 10 db lower than the best type of low-level circuits, and a corresponding decrease in sensitivity to tube hiss and the "shot" effect of amplifier input tubes.

#### STUDIO CONTROL CONSOLE

Since the mixing panel or console is the central control and distribution point for all programs originating in or outside the studio, it may well be termed the "heart" or "brain" of the entire program facilities. In fact, one can hardly name a type of program in which at least two mixing points are not employed. A certain type of network program includes mixing and pickup points in a number of widely separated cities, with the master control point being located in still another city. In another case, a remote pickup, constituting one mixing point, is fed through a studio mixer (the second

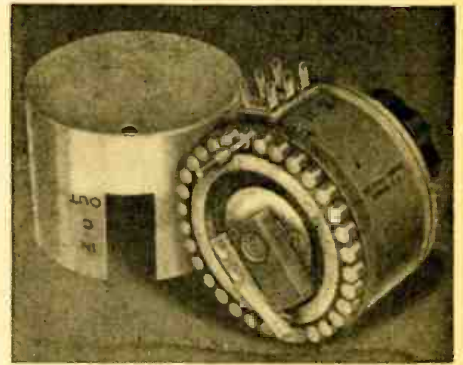

Typical variable attenuator (ladder network).

mixer point), where local announcements are inserted, and the combined programs fed to either the third mixing point at Master Control or to the speech input equipment of the transmitter.

Keynote in studio console design should be simplicity, flexibility, ease of operation and quick access to all associated gear, with neatness and compactness playing important parts. Design simplicity reduces percentage of operating error by eliminating elements

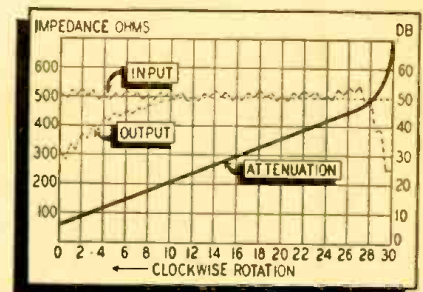

Fig. 3—Curve of attenuator pictured above.

of confusion, while flexibility of operation allows adaption to a wide variety of programs, and facilitates easy switching or circuit patching in case of equipment failure. Flexibility is greatly increased by terminating the input and output circuits of all pre-amplifiers, amplifiers, attenuators, keys and other operating facilities in a jack strip or panel, the circuits being *normal* to allow transfer of any part of equipment to another circuit.

The input and output terminations of the line or program amplifier are usually connected to a "multiple" set of jacks which allow patching into either circuit without program interruption.

(Continued on page 863)



Appearance of the RCA 76-B2 Studio Control Console, a typical and commonly-used type.

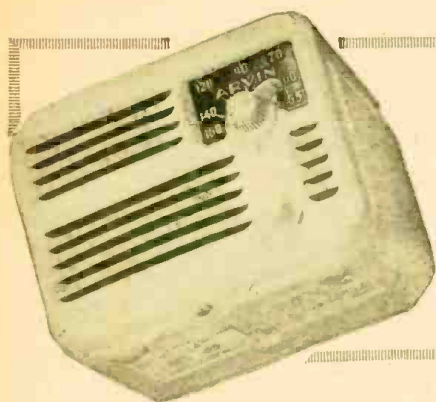

# THE POSTWAR RADIOS

## Arvin Model 444

**T**HE Arvin Model 444 is one of the more unusual post-war radios in its class. It uses four full-size tubes in an efficient a.c.-d.c. superheterodyne circuit. It is housed in a cabinet of modern design 6½ inches long by 5 inches high by 4 inches deep. From all outward appearances, the cabinets seem to be made of thin plastic. Close examination shows that they have been stamped from heavy sheet metal. Careful tests discovered no cabinet resonance or "ringing" even at high volume levels.

The Model 444 uses a 12SA7 mixer-oscillator, 12SQ7 second detector, a.v.c. and a.f. amplifier, 50L6-GT a.f. output and 35Z5-GT half wave rectifier.

A 25-foot "hank" antenna replaces the relatively inefficient loop antenna commonly used on sets of this type. The secondary of the antenna coil is tuned by one section of the cut-plate ganged tuning condenser.

The smaller condenser section tunes the oscillator, which is a modified Hartley circuit with the tickler coil connected in the cathode circuit. The tuning

condenser gang is insulated from the chassis and cabinet to prevent the user from being shocked by coming in contact with a "hot" chassis. The rotors of the condensers are connected to the a.v.c. line.

There is no i.f. stage in this receiver. The 455-kc i.f. signal from the plate of the mixer is transformer coupled direct to one detector diode. The B-plus lead to the mixer plate is connected to a tap on the primary of the i.f. transformer instead of to the bottom of the coil in the conventional manner. This connection increases the amplification and selectivity of the set.

The second detector uses a standard half-wave circuit. A 2-megohm volume control is connected so that it will serve as a diode load for the detector. The d.c. voltage drop across this resistor is filtered by a 4.7-megohm resistor and 100-μf condenser and used as a.v.c. voltage for the mixer. The a.f. signal is fed to the grid of the triode section of the 12SQ7. Resistance-capacity coupling is used between the plate of the 12SQ7 and the 50L6-GT; a pentode connected, beam-power amplifier supplies more than 2 watts of audio power to a 4-inch PM speaker.

The tuning dial, 2 inches long by 1½ inch high, is calibrated at 550, 600, 700, 900, 1200, 1400 and 1600 kc. In each  
(Continued on page 873)

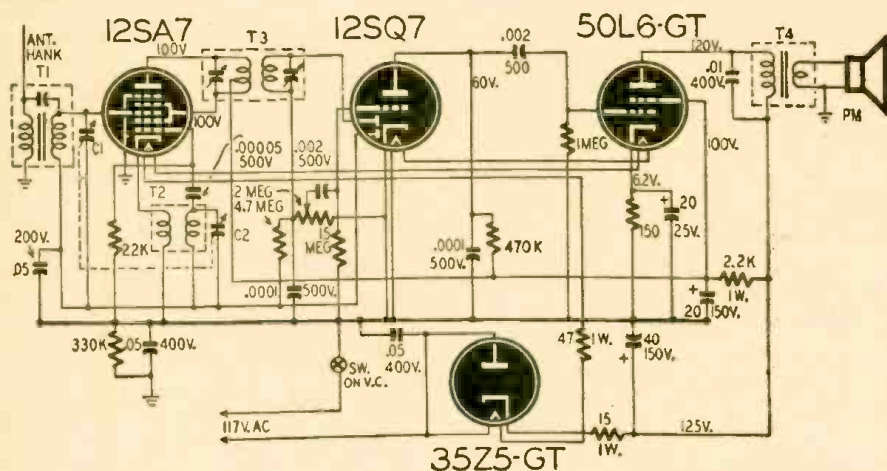
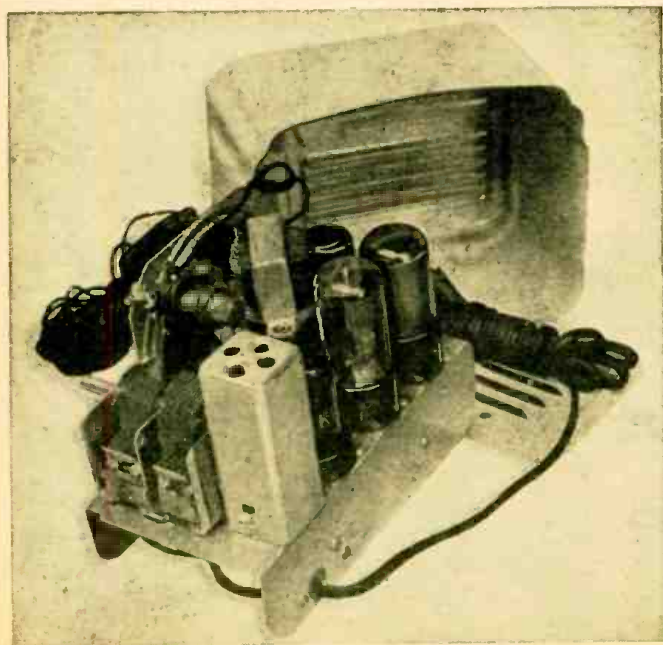
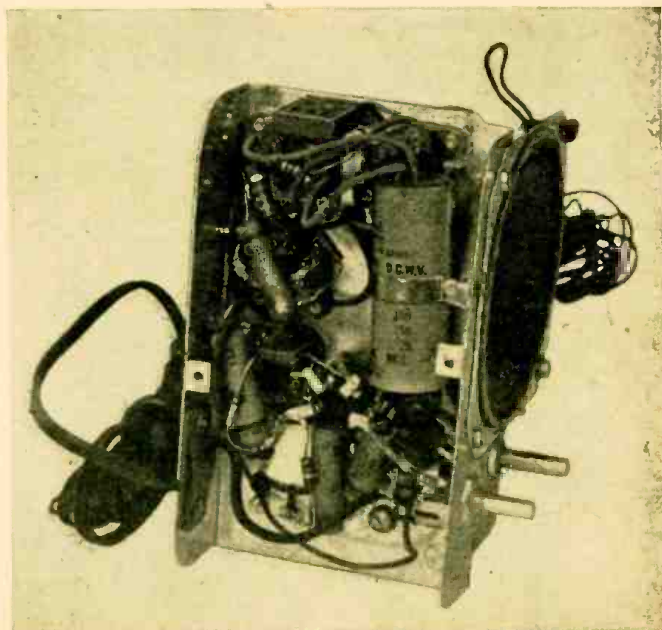

Diagram of the Model 444. Positive feedback in the i.f. circuit is especially interesting.



The Arvin out of its case. Cut-plate condenser is plainly seen.



Under-chassis view of the receiver. Parts are standard midget type.

# RADIO TEST EQUIPMENT

## Realizing the Most from a Meter in Radio Servicing

**T**EST equipment used by radio-servicemen must cover a large voltage, current, and resistance range. Voltages may be as low as a few microvolts in radio receivers and as large as 10,000 volts on peaks in television receivers. Currents may be as high as 10 amperes in automobile receivers and as low as a few microamperes in the plate and a.v.c. circuits. Resistances may be a fraction of an ohm and may run as high as several million ohms. The extreme ranges, make it imperative that the user know exactly what is happening in his tester. A working knowledge may mean the difference between a quick repair and a burnt-out tester and the loss of the money invested.

The D'Arsonval is the foundation movement for most radio test equipment in use today. This part is the heart of the tester.

It consists of a wire coil rotating on pivots, set in jewels and mounted in the field of a powerful magnet. Springs mounted above and below the coil serve as connectors to the coil, allowing the entry and exodus of current, and also as the restoring torque to return the coil and attached pointer to its original position. Sensitivity of the meter is governed by the strength of the magnet, number of turns on the coil, and strength of the springs.

The most common sensitivity in use today is one milliamper (1,000 microamperes) full-scale deflection. (200-microampere and 50-microampere movements are also in use, but their high price and extreme delicateness limit their popularity.) D'Arsonval meters are made with current sensitivities of 40  $\mu$ a to 10 ma (self-contained). Meters with higher ranges than 10 ma usually have shunts built into their cases. The D'Arsonval movement is usually made with a scale arc of either 90° or 100°. 270° meters are available. A 4-inch meter having a 270° arc, has the same scale length as a 7-inch meter having a 90° arc. The accuracy of the smaller model is 2 percent of full scale. Larger models can be built to an accuracy better than 1/10th of one percent. When it is necessary to measure currents in excess of about 10 milliamperes, most of the current is made to flow around the meter. The device which permits this is a *shunt*. Shunts are made in two movement types, the single-range and the multiple-range or *Ayrton shunt* (sometimes called the *ring shunt*).

The single-range shunt (Fig. 1) consists of a resistor placed across a meter, thus reducing its sensitivity. If we assume a meter with a sensitivity of 1 ma and a resistance of 100 ohms (100 millivolts), and desire to measure 10 ma

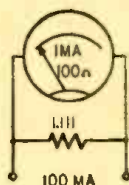

Fig. 1—A simple shunt, designed to step up the current-carrying capacity of the meter by a multiplication factor of one hundred.

of current, a shunt is constructed so that 9 ma flows through the shunt.

Therefore the shunt must furnish 9 1-ma paths in parallel, while the meter is the tenth. This gives us a formula for calculating the shunt resistance, which is

Resistance of the meter

No. of times range is multiplied - 1

If the shunt is to have 9 times the current-carrying capacity of the meter, obviously it will have one-ninth the resistance. This, paralleled with the resistance of the meter, will result in a 10-fold increase in the reading. In mathematical language this is expressed:  $RM/N-1$ , where RM is the meter resistance and N is the number of times the range is to be multiplied. In this case:

$$\frac{RM}{N-1} = \frac{100}{10-1} = \frac{100}{9} = 11.1 \text{ ohms}$$

The single-range shunt has many disadvantages. In a multi-range instrument, the meter is not protected when changing ranges unless a shorting type switch is used. Since a different resistance is across the meter for each range, damping of the meter will vary. This means that for the higher currents, it will become more and more sluggish, the pointer requiring more time till it comes to rest. Any pivot friction or dirt in the jewels or on the springs will show up, causing the meter to stick.

The Ayrton shunt (Fig. 2) consists of several resistances, all connected in series, connected across the meter. The total of all the resistances can be any value consistent with good damping upon the meter movement.

Assume a 400  $\mu$ a (.4 ma) meter having a resistance of 150 ohms. It is desired to build a multi-range ammeter having full scale ranges of 3, 15, 60 and 150 ma and 3, 15, and 30 amps. The

total circuit resistance is 1350 ohms for all the resistances and 150 ohms for the meter or 1500 ohms.

R total

R needed =

N (multiplication factor)

The multiplication factors for the various ranges would therefore be x7.5, x37.5, x150, x375, x7,500, x37,500 and x75,000;

the resistances would be— 200 ohms, 40 ohms, 10 ohms, 4 ohms, .2 ohm, .04 ohm, and .02 ohm.

An additional 1150-ohm resistor completes the circuit. The higher shunt resistance is for improved damping. The actual resistances used are 160 ohms, 30 ohms, 6 ohms, 3.8 ohm, .16 ohm, .02 ohm, and .02 ohm, as they are all in series.

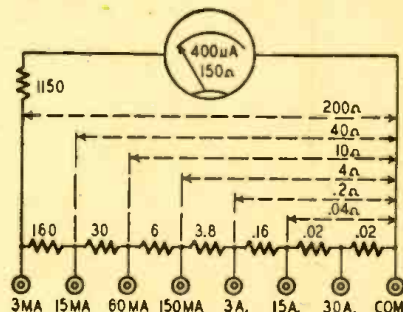

Fig. 2—The Ayrton shunt applied to a meter.

Since the meter "looks into" a resistance of 1350 ohms for all ranges, meter damping remains the same throughout.

### D'ARSONVAL MOVEMENT AS VOLTMETER

A multiplier resistance is used in conjunction with the meter to measure voltage. If we have a 1-ma meter, having an internal resistance of 100 ohms (100 mv.), and desire to extend the range of the meter to 10 volts, a resistor is added in series. The resistor is so chosen that a 9.9 volt drop appears across the resistance and only .1 volt (100 mv) appears across the meter. (See Fig. 3). The resistance of the multiplier would then be:

$$R = \frac{E}{I} = \frac{9.9}{.001} = 9,900 \text{ ohms}$$

A multiplier to extend the range of the meter to 100 volts would be:

$$R = \frac{99.9}{.001} = 99,900 \text{ ohms}$$

It is customary to disregard meter drop for ranges above 50 volts on all

except the highly precise laboratory volt-meters.

Many test equipment manufacturers use series multipliers in place of individual multipliers. A series multiplier to extend our 1-ma 100-ohm meter to 1, 10, and 100 volts would be 900 ohms, 9000 ohms, 90,000 ohms. (Fig. 4) The 900 ohms section is used for the 1 volt range. The 900 ohm and 9,000 ohm resistors are used for the 10-volt range.

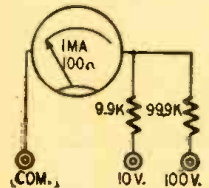

Fig. 3—A milliammeter hooked up with a pair of voltage-dropping resistors as a two-range voltmeter.

All three are used for the 100-volt range.

When measuring a.c. voltage with a D'Arsonval or any other meter that does not respond to a.c., a means must be employed to convert the a.c. to d.c. Several methods are employed.

Thermocouples are used when the frequency range varies and precisions is of prime importance. Rectifiers (thermionic), copper-oxide, copper-sulfide,

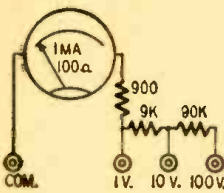

Fig. 4—A voltmeter with the resistors hooked up in series.

selenium, germanium are used where cost is important.

Copper-oxide rectifiers are the most common rectifiers in use today for changing a.c. to d.c. in instruments. Copper sulfide and selenium are also used, and all circuits described can use either of these rectifiers in place of the copper-oxide.

The rectifier can be connected several ways. The simplest method is to insert it in series with one of the leads of the d.c. meter. There are several disadvantages. The meter scale would be far from linear. The ohms-per-volt and cali-

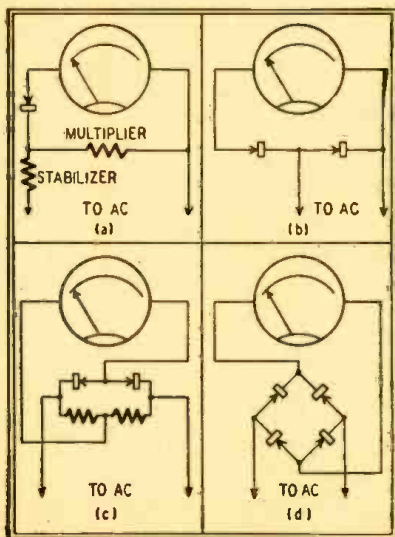

Fig. 5—Rectifier circuits described in text.

bration of the meter would be different for each range in a multirange instrument. These changes are caused by the varying load presented to the rectifier by the various multipliers and by the ratio of multiplier resistance to inverse resistance of the rectifier.

The simple rectifier arrangement can be greatly improved by inserting a resistor in series with the rectifier and placing both across the meter, with connections as in Fig. 5-a. It is immaterial whether the resistor or the rectifier is in shunt with the multiplier.

The resistor tends to both equalize the load of the rectifier and reduce the inverse current, giving a better scale distribution and the same ohms-per-volt for each range. The resistor should be preferably less than 1,000 ohms. Although higher values give a more linear scale, they also tend to increase the inverse voltage across the rectifier. A better arrangement is to use a second rectifier unit in place of the resistor, as shown in Fig. 5-b. The second rectifier acts as a "short" during the conducting cycle and as a very high resistance during the non-conducting cycle. With such an arrangement, the scale is almost linear and the ohms-per-volt of the meter is increased.

The above are half-wave circuits and are popular in multi-range instruments. Full wave circuits are also used. The full wave version of the first example (Fig. 5-c) has two rectifiers connected back-to-back and two resistances. The full wave version of the second example is the bridge rectifier (Fig. 5-d). The only real advantage of the full wave circuit over the half-wave is the ohms-per-volt, which is greater in the full wave circuit.

#### OHMMETER CIRCUITS

Two general circuits are used for measuring resistances in radio test equipment. For resistances below 250 ohms, a shunt ohmmeter is usually used. For resistances above 100 ohms, the series ohmmeter is used.

In the shunt ohmmeter, a meter, resistor, and battery are connected in series and the resistor is adjusted so that the meter reads full scale. The unknown resistance is then placed across the meter (acting as the single-range shunt described previously). The current flowing through the battery and resistor will then divide and flow through both the meter and unknown resistor (Fig. 6) thus causing the meter reading to decrease. As an example, assume a meter with a full scale sensitivity of 1 ma and a resistance of 50 ohms. A 1450 ohms resistor used with a 1.5-volt cell will cause the meter to read full scale. If an unknown resistor is placed across the meter and the reading drops to 1/2 scale, the unknown will be 50 ohms. This is true since 1/2 of the current (.5 ma) would flow through the meter and 1/2 through the 50 ohms shunt. The meter would then register only 1/2 ma. This can be written as a formula

$$\frac{I_1}{I_1 - I_2} \times R_m,$$

when  $I_1$  = full scale current of instru-

ment,  $I_2$  = new scale current with shunt added and  $R_m$  = Resistance of meter.

An unknown resistor causing the meter to read 1/2 of the scale will therefore be:

$$\frac{.25 \text{ ma}}{1 \text{ ma} - .25 \text{ ma}} \times 50 = \frac{1}{3} \times 50 = 16 \frac{2}{3} \text{ ohms.}$$

The shunt ohmmeter scale would therefore have its zero point to the left as in

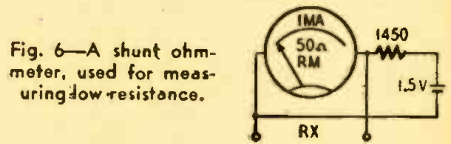
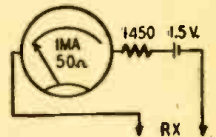

Fig. 6—A shunt ohmmeter, used for measuring low resistance.

voltage and current readings. Such a resistance scale is called a "kick-back" scale since the meter kicks backwards when a resistance is measured. The shunt ohmmeter is a milliammeter with a variable shunt.

The series ohmmeter is basically a voltmeter with a variable multiplier. It is more common than the shunt ohmmeter and will read higher resistance values. It consists of a meter, battery, and current-limiting resistor such as used in the shunt ohmmeter, but the unknown resistance is placed in series

Fig. 7—Simple series ohmmeter circuit, as commonly employed in cheap test equipment.



with the circuit (Fig. 7). If the same 1-ma, 50-ohm meter, 1450-ohm resistor, and 1 1/2-volt battery is used, and the unknown resistor causes the meter to read half-scale, the unknown resistance is equal to the circuit resistance, 1500 ohms. The circuit resistance is composed of the 1450-ohm series resistor and the 50-ohm meter resistance. This can also be written as

$$\frac{E_1 - E_2}{E_2} \times RT,$$

where  $E_1$  is the full scale reading in volts,  $E_2$  is the new scale reading in volts with the unknown resistance added, and  $RT$  is the total circuit resistance with the unknown resistance out of the circuit. If the above meter should read 1/3 scale with the unknown resistance in circuit, the resistance would therefore be

$$\frac{1.5 - .5}{.5} \times 1500 = 3000 \text{ ohms.}$$

The series ohmmeter has the zero (Continued on page 861)

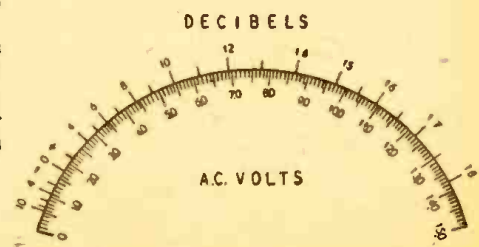

Fig. 8—Decibel adaption chart for voltmeter.



# RADIO DATA SHEET 339

## OLYMPIC RADIO—Models 6-501, 6-502, 6-503

Frequency Range ..... 535—1700 K.C.  
 Power Requirement ..... 105—125 volts Alternating or Direct current  
 Power Consumption ..... 30 Watts

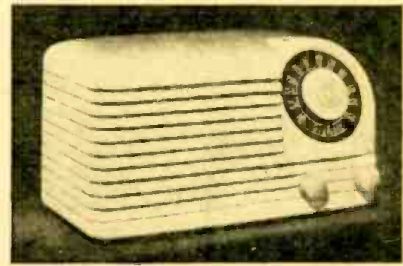

Models 6-501, 6-502, 6-503 are five tube AC or DC operated superheterodyne radio receivers employing a built-in loop antenna which will provide satisfactory reception under all normal conditions. This type of antenna is directional and noise or interference from other stations can be minimized by rotating the receiver. If the receiver is used in locations where signal strength is very low, as in steel buildings, or in locations remote from broadcast stations, an outside antenna may be connected to the screw protruding through the back of the cabinet. A GROUND CONNECTION IS NOT REQUIRED AND MUST NOT BE USED.

### REPLACEMENT PARTS

- Part No. Description  
 CO-107—Capacitor—Electrolytic 40+40/150WV  
 CV-501—Condenser—2 gang variable tuning condenser  
 RCM20A101M—Capacitor—100 mmf ± 20% mica  
 RCM20A221M—Capacitor—220 mmf ± 20% mica  
 RCM20A331M—Capacitor—330 mmf ± 20% mica  
 RCP10W2203A—Capacitor—.02 mfd., 200 volts tubular  
 RCP10W4503A—Capacitor—.05 mfd., 400 volts tubular  
 RCP10W6103A—Capacitor—.01 mfd., 600 volts tubular  
 REB106M—Resistor—10 meg., ± 20% 1/2 watt  
 REB121K—Resistor—120 ohms ± 10% 1/2 watt  
 REB225M—Resistor—2.2 meg., ± 20% 1/2 watt  
 REB474M—Resistor—470,000 ohms ± 20% 1/2 watt  
 REB822K—Resistor—8200 ohms ± 10% 1/2 watt  
 REC221K—Resistor—220 ohms ± 10% 1 watt  
 SK-110—Speaker—5" Dynamic with output transformer  
 TR-186—Transformer—1st or 2nd I.F. transformer

### NOTES

- All resistors ± 20% tolerance, 1/2 watt, unless otherwise specified.
- All mica condensers ± 20% tolerance.
- All voltages measured to chassis (B-) with 20,000 ohms-per-volt meter, with volume control full on.

### ALIGNMENT PROCEDURE

WHEN SERVICING THIS RECEIVER DO NOT PLACE CHASSIS ON A GROUNDED METALLIC BENCH.

Equipment Required:

Modulated R.F. signal generator; output meter; insulated screw-driver; two .1 mfd 400 volt and one 50 mmfd 400 volt condensers.

To align the receiver it is necessary to remove the chassis from the cabinet, check that the pointer is horizontal and coincides with the two horizontal reference lines on the dial. In this position the condenser should be completely closed. Connect the output meter and signal generator to the receiver as follows:

Output meter—Connect across voice coil and turn volume control to maximum. Signal generator—Connect the low side of the signal generator to the receiver chassis through a .1 mfd condenser and keep the output as low as possible, then proceed in the sequence shown on the alignment chart.

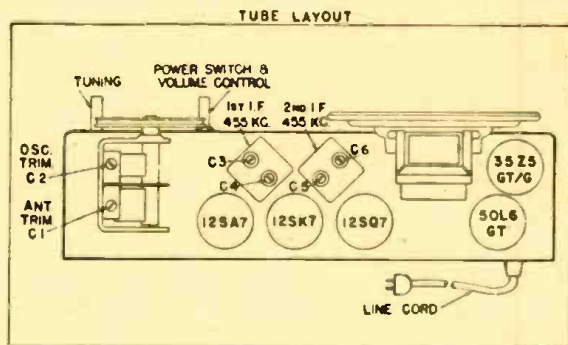

### ALIGNMENT PROCEDURE CHART

Step	Connect High Side of Signal Generator To—	Set Signal Generator To—	Turn Receiver Dial To—	Adjust the Following for Maximum Output. (Keep Signal from Signal Generator as Low as Possible.)
1	Antenna Section Tuning Cond. in Series with .1 mfd Cond.	455 KC.	Full Clockwise Position. (Cond. Plates Fully Open)	C6, C5, C4, C3 and repeat in same order (1st and 2nd I.F. Transformers)
2	Antenna Term.	1700 KC.	1700 KC. (170 on Dial)	C2 (Oscillator)
3	of Antenna Loop in Series with	1400 KC.	Maximum Signal (Approx. 140 on Dial)	C1 (Antenna)
4	50 mmfd Cond.	Repeat Steps 2 and 3		

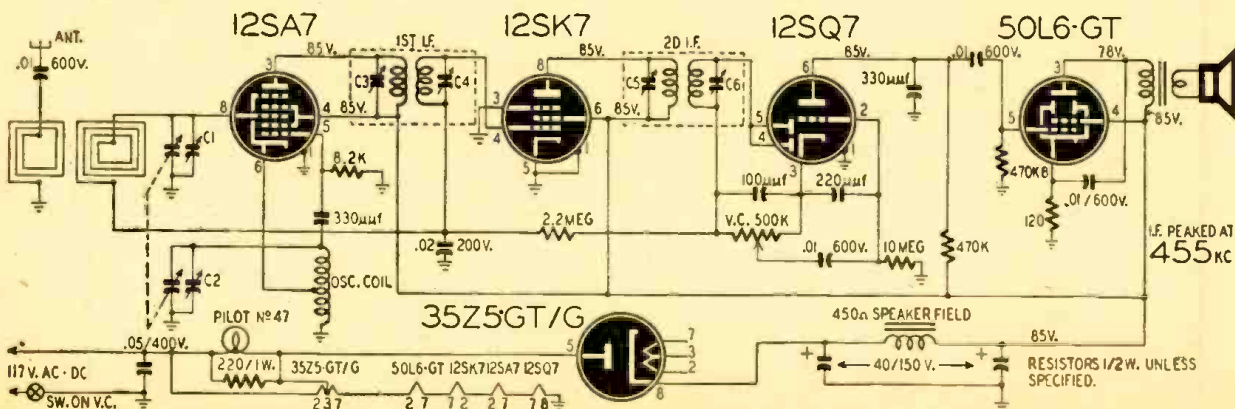

# TELEVISION FOR TODAY

## Part IV—Television R.F. and I.F. Stages

**A**N R.F. STAGE in any super-heterodyne receiver is designed to:

1. Increase sensitivity.
2. Increase selectivity.
3. Improve the signal-to-noise ratio.
4. Reject image signals.
5. Reject signals at intermediate frequency.

At the frequencies allocated to television (44-216 mc) we find that the usefulness of an r.f. amplifier is not as great as it would be at the considerably lower broadcast frequencies (550 to 1700 kc). The reason: use of a higher signal frequency coupled with the greater separation between the range of frequencies at which the r.f. amplifier operates as compared to the i.f. frequency.

Consider, for example, item 5. Present RMA standards place the video i.f. at 25.75 mc, while the sound i.f. is 21.25 mc. These signals would hardly be capable of developing sufficient voltages at the receiver input to cause interference in the i.f. channel. The lowest television channel is at 44-50 mc, which is a full 19 mc removed. At the higher frequencies the conditions are even more favorable.

Rejection of image frequencies is important. It is well-known that as long as the intermediate frequency chosen

is greater than half the band allotted for transmission, no trouble will be encountered from image frequencies. The thirteen television channels are divided into two groups: those from 44-88 mc and those from 174-216 mc. The width of one band is 44 mc, the other 42. Half of the largest is 22 mc, which is less than the 25.75 mc video i.f. frequency. Hence practically no trouble may be expected from image frequencies.

At high frequencies selectivity contributed by an r.f. stage is low. Fig. 1 illustrates a comparison between the selectivity curves of two receivers, one with, one without an r.f. stage. The only apparent difference occurs at the edges of the band.

The gain of an r.f. stage, in most high-frequency receivers tested, averaged between 5 and 8. A comparable i.f. stage would be capable of a gain of 20 to 30. Hence, from the standpoint of gain alone, an additional i.f. stage would be preferable to an added r.f. stage. It is questionable, too, whether this comparatively small gain would be sufficient to raise an otherwise weak signal to the point where it can produce satisfactory reception. Observers are very sensitive to even slight distortions or poor quality in images. It has been the author's experience that an r.f.

stage seldom proved decisive in raising a really weak signal to the point where enjoyable reception became possible.

The foregoing does not infer that no r.f. stages will be incorporated in television receivers. It does mean, however, that the question of whether or not an r.f. stage is to be incorporated must be tempered with the problem on hand. Television is a special design requiring its own solution. An r.f. amplifier will definitely prove helpful in borderline cases, where the additional gain is sufficient to bring the signal in and produce a clear

signal. But when the signal is quite weak, an r.f. stage does *not* help it clear the hurdle. In these instances the antenna should either be improved, or else the station forgotten.

The form of the r.f. stages follows conventional lines. In Fig. 2, we have a typical r.f. stage using any of the newer tubes, such as the 6AU6, the

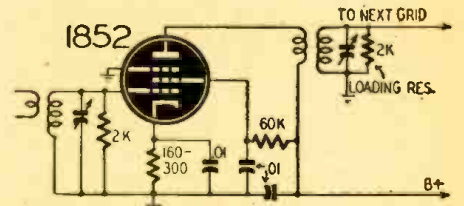

Fig. 2—Typical r.f. stage in television set.

6BA6, 7AG7, or the 6AC7/1852. High  $G_m$  and low internal capacitances are the criteria by which such tubes chosen. In fact, these quantities are so important, they are oftentimes combined into a ratio

$$\frac{G_m}{C_{in} + C_{out}}$$

known as the "Figure of Merit."

Because the internal tube capacitance is part of the input tuned circuit, special efforts are made to minimize the inevitable changes that occur in these capacitances with tube operation. One

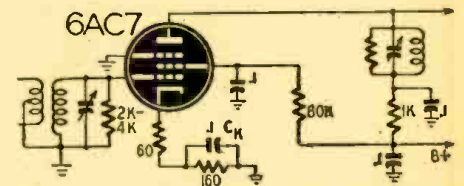

Fig. 3—A small amount of degeneration cuts down the effect of changes in tube capacity.

common arrangement is shown in Fig. 3 and consists of a small amount of degeneration introduced by the unby-passed portion of the cathode resistor. In doing this, however, the cathode is no longer directly connected to the condenser  $C_k$  and is not at a.c. ground potential. Under these circumstances, the screen condenser and the suppressor grid should be tied directly to ground instead of the cathode itself.

The resistor loading of the tuned circuit flattens out the response, as shown in Fig. 1. Its greatest disadvantage lies in the fact that this likewise decreases the gain. This is the main reason for the low gain of television tuned amplifiers. A tuning circuit, when connected across the output of tube, is essentially in series with the plate resistance of that

(Continued on page 864)

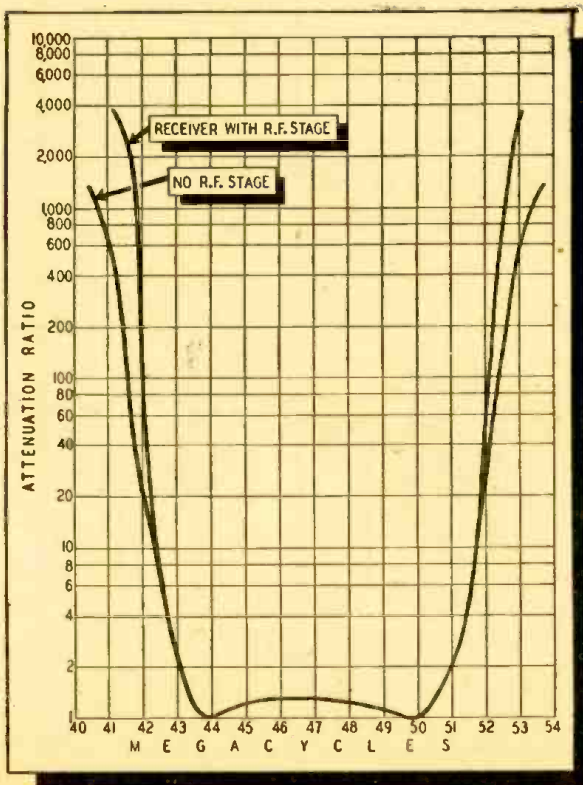
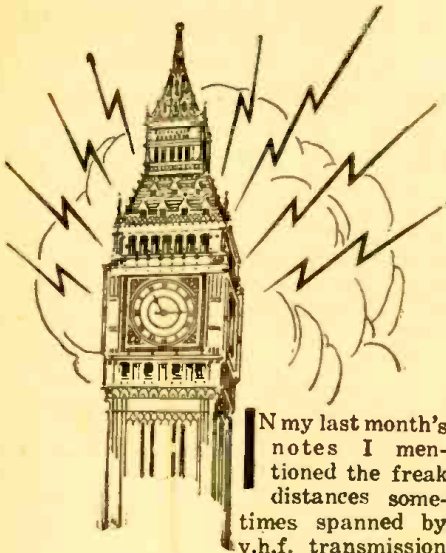

Fig. 1—Increased selectivity due to r.f.

# TRANSATLANTIC NEWS

From our European Correspondent, Major Ralph Hallows



In my last month's notes I mentioned the freak distances sometimes spanned by v.h.f. transmission just now. A remarkable instance occurred here on June 8, when our television service reopened with a broadcast of the victory procession through London. Both sound and vision on frequencies of the order of 42 mc were well received by an amateur enthusiast on a home-built set at Minehead, Somersetshire. Minehead is on the Bristol Channel, over 170 miles from the transmitter at the Alexandra Palace, near London. Between London and Minehead are several ranges of hills and Minehead itself is, one would have thought, heavily screened from the direction of London by the heights of

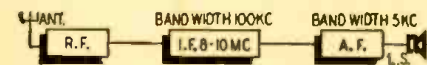

Fig. 1—Diversity reception with one receiver.

Exmoor, at whose foot it lies. There is a lot that we still don't know about the behavior of the meter-waves. Certainly their range may often be a long way beyond the visual horizon, which was once thought to be their limit.

## THE TONE-CONTROL PROBLEM

Sometime ago I raised over here the question why in nine out of ten homes one finds the radio receiver operating with the tone control knob turned as far anti-clockwise as it will go. The effect of this in most cases is to cut completely the audio frequencies above about 3,500-4,000 cycles. At first sight the thing is most mysterious. Apart from radio the normal man and woman obviously likes the high-pitched sounds of music. The violinist who does gymnastics in concert hall or music hall on the harmonies of the E string and the soprano who hits high-C are certain to receive rapturous applause. But with his radio set the average listener firmly deprives violinist and soprano of the opportunity of properly hitting any high spots. There must be some scientific reason for this, but no one yet seems to have been able to find it.

The most likely explanation of people's dislike of "top" in radio reproduction is that the effects of many kinds of distortion, particularly harmonic dis-

tortion, high-frequency beaming and the results of misaligning preset tuned circuits, are much less distressing when the top is cut. This seems to open a promising field for research and invention, for people want the high audio frequencies, but not as the radio receiver now reproduces them.

## STILL PICTURES IN COLOR

The great British telecommunications corporation, Cable & Wireless, conducts world-wide still picture transmission services in addition to its activities in the sphere of telegraphy. It has recently made an outstanding advance in the matter of still pictures in color. Hitherto all such pictures have suffered from one shortcoming which detracted very much from their appeal to the eye. No doubt you have seen many in your illustrated journals and you can hardly have failed to be struck by the undue predominance of greenish-yellow hues in them. The blues, reds and browns are there, but they are to a large extent swamped and the whole picture gives an unpleasing impression of sallowness. I have just lately seen colored stills transmitted between Britain and Australia which are vastly better than anything of the kind produced by any other process. The trouble experienced in the past has been found to be due to what is called the yellow image.

When a still picture in color is transmitted by radio by the four-color process no less than six transmissions of the

image have to be made. Four of these are made through colored screens; red, blue, green and yellow. The fifth shows the blacks. The sixth is a kind of key diagram, showing the relative intensity of the tints. From the first five of these the block-maker makes the blocks and with them the printer superimposes one color upon another. Till now a proper balance has been unobtainable, possibly because the yellow tints in the original forced their way, so to speak, on to other images besides the yellow, with the result that the cumulative effect of the successive printings was to give undue emphasis to this color.

## V.H.F. DIVERSITY AM TRANSMISSION

A remarkable system of multi-carrier amplitude-modulated radio on frequencies of the order of 100 mc has been developed for the British police and fire fighting services. The first experiments were made with FM, two stations, 28 miles apart being used. Operating on 81.7 mc, with temperature-controlled transmitter crystals, the stations had common modulation applied from a central control point. It was found that there was a large area, the "area of no-capture," in which neither transmitter took complete charge of a mobile receiver and serious distortion of speech took place.

Experiments were therefore made with AM. It was decided not to attempt to synchronize the two carriers, but to

(Continued on page 873)

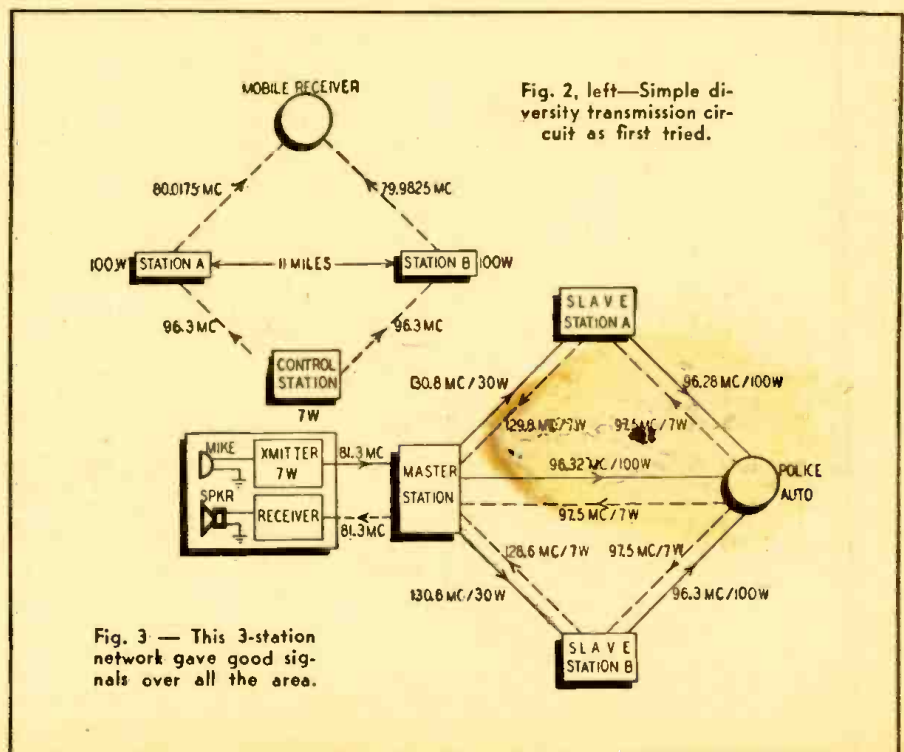

Fig. 2, left—Simple diversity transmission circuit as first tried.

Fig. 3 — This 3-station network gave good signals over all the area.

# WORLD-WIDE STATION LIST

**F**ROM Africa the signals of "Radio Dakar" go booming through the ether to the antennas of radio sets the world over. Reports reach the studios daily telling how the station is received in Australia, the British Isles, and the Americas, as well as France, Sweden and the Near East.

For the benefit of those listeners this story has been written by William S. Duggan, Jr., of Goshen, New York; as he saw it in Dakar, at the studios and transmitter site of *Poste Fédéral Radio-Dakar*.

Poste Fédéral Radio-Dakar is supervised and controlled by the French government. Its daily transmissions are confined to the area of Africa known technically as *Afrique Occidentale Française*. All programs are in the French language, although some discs are cut with English music on them. The studios of the stations are located on the Rue Felix Faure, in the military district of uptown Dakar.

Radio Dakar, using the call letters FGY, operates at present time on two frequencies, namely 25.61 meters (11.715 megacycles) and 43.37 meters (6.917 megacycles) with transmitter powers of 12 kilowatts and 1200 watts respectively. As a general call to all African listeners, the station transmits a carrier wave upon which is superimposed a group of modulated tone signals, which are used to help listeners identify the station. The identification broadcast consists of high-medium-low tones, which are emitted for fifteen minutes prior to the general transmission.

Every general transmission from FGY begins with the playing of the

"French Infantry Hymn," which has a duration of three minutes. Transmissions from Radio-Dakar begin each day at 0700 hours GMT (2 am EST), 1200 hours GMT (7 am EST), and 1800 hours GMT (1 pm EST). News in French comes at 0715 to 0730 hours GMT; 1230 to 1245 hours GMT; and from 1930 to 1945 hours GMT. A final

## RADIO TERM ILLUSTRATED



"Link Coupling"

broadcast of World Wide news is at 2115 hours GMT. A special programme for the Oualof tribe of Senegal is also broadcast in the service from Radio-Dakar. In tribute to the gallant service of this tribe in the French forces during the 1st World War the program is broadcast at the following times: In French on the 1st Monday of each

month at 1235 hours GMT and in the Oualof native tongue on every second Tuesday of the month at 1235 hours GMT.

Transmitter sites for FGY are at Hann, a small village about eight miles from Dakar. The monitoring receiver is a Hallicrafters SX-28 receiver with a Panoramscope of 200 kilocycles bandwidth.

Here is a feature that may be of interest to all of you. Radio-Dakar runs a musical request program every week whose selections are requested by listeners to the service. Those wishing to have their favorite classical or light music played should write to the studios giving the name of the request, along with their name and address. Send all requests to: Musical Request Department; Poste Fédéral Radio-Dakar; Rue Felix Faure; Dakar, Sénégal; *Afrique Occidentale Française*.

All correct reception reports concerning the reception of FGY's signals abroad by listeners are very cordially welcomed and will be verified by letter or postal card. At the present time Radio-Dakar does not have an official printed verification card, but all reports will receive a reply. Please inclose an International Reply Coupon. All reception reports should be addressed to M. LaCroix; Poste Fédéral Radio-Dakar; Rue Felix Faure; Dakar, Sénégal; *Afrique Occidentale Française*.

We wish to thank Mr. Duggan, who was a reporter for this department prior to his service with the armed forces; and the officials of Radio-Dakar, who cooperated with Mr. Duggan in making this information available.

*All Schedules are Eastern Standard Time*

Location	Station	Frequency and Schedule	Location	Station	Frequency and Schedule	Location	Station	Frequency and Schedule		
EL SALVADOR	YPSA	10.400 evenings								
San Salvador					12:30 am; Ceylon beam, 9 to 11 pm; Middle East beam, 11 pm to 1 am; Italian beam, midnight to 4 am; 12:15 to 4 pm; Southwest Pacific beam, 1 to 4 am	London	GVW	11.700		
ENGLAND	GRC	2.880						am; Northwest Pacific beam, 7 to 9:30 am		
London	GRB	6.010						Southwest Pacific beam, 1 to 5 am; Indian beam, 11 pm to 1 am; South African beam, 10:30 am to 4 pm; Near East beam, 1 to 4 pm		
London	GWS	6.035						South African beam, 12:30 to 3 am; 10:30 am to 4 pm; West African beam, 1 to 3 am; South American beam, 4:15 to 10:15 pm; Central American beam, 4:15 to 9 pm; Mediterranean beam, 1 to 4 am; 6 to 10 am; 10:30 am to 2:30 pm; North African beam, 2 to 4 am; 6 to 10 am; 10:30 am to 4 pm		
London	GRR	6.070	Central American beam, 8 to 10:15 pm	London	GWB	9.550		West African beam, 3 to 4 pm; Mediterranean beam, 12:30 to 1:45 am		
London	GWM	6.090	Near East beam, 11 pm to 12:30 am; Italian beam, 11 pm to 12:30 am	London	GSC	9.580	Central American beam, 6 to 10:15 pm; Indian beam, 8 to 9:15 pm	London	GSD	11.750
London	GSL	6.110		London	GRY	9.600	South African beam, noon to 4 pm; Near East beam, 3 to 4 pm; Far East beam, 11 pm to 2:30 am; Northwest Pacific beam, 11 pm to 1:45 am			
London	GWA	8.125								
London	GRW	8.150								
London	GRK	8.165								
London	GRM	7.120	Australia beam, 1 to 4:45 am; New Zealand beam, 1 to 8:45 am; Indian beam, 9 to 11 pm; Southwest Pacific beam, 1 to 4 am	London	GW0	9.625	West African beam, 11:30 pm to 1:45 am; 4:15 to 5:45 pm; Mediterranean beam, 12:30 to 1:45 am	London	GSN	11.820
London	GSW	7.200		London	GVZ	9.640	North American beam, 7 to 11 pm; New Zealand beam, 1 to 3 am	London	GSU	4.280
London	GSU	4.280	North American beam, 7 to 11 pm	London	GWP	9.660	Far East beam, 8:45 to 10:15 am	London	GRJ	7.320
London	GRJ	7.320	Northwestern Pacific beam, 11 pm to 12:30 am; Italian beam, 11 pm to 12:30 am; Far Eastern beam, 11 pm to 12:30 am; South American beam, 6 to 10:15 pm; Near East beam, 11 pm to 12:30 am	London	GRM	9.825	North American beam, 5 to 11 pm; Central and South African beam, 11 pm to 1:45 am; North African beam, 11 pm to 1:45 am	London	GRV	11.840
London	GRV	11.840		London	GRN	9.825	North American beam, 5 to 11 pm; Central and South African beam, 11 pm to 1:45 am; North African beam, 11 pm to 1:45 am	London	GRF	12.095
London	GRF	12.095		London	GRU	9.915	North African beam, 12:15 to 4 pm; South African beam, 12:15 to 4 pm	London	GRG	11.680
London	GRG	11.680	Far East beam, 7 to 9							
London	GWF	9.490	Near East beam, 11 pm to 12:30 am; 12:15 to 4 pm; South American beam, 4:15 to 10:15 pm; Indian beam, 11 pm to							
London	GSB	9.510								

(Continued on page 857)

# WE'LL "LEND" YOU ANY OF THESE 3 GREAT BOOKS *for* 5 FULL DAYS

Every Cent of Your Money Cheerfully Refunded  
if You're Not More Than Satisfied



**ONLY \$5  
EACH**

The most and best Training  
for your money—You  
be the judge!



Get a better job—start a  
business of your own in  
fascinating Radio-Electronics!

## LEARN PROFESSIONAL SERVICING WORK at home

A. A. Ghirardi's big, 1300-page MODERN RADIO SERVICING is the finest, most complete instruction course on Radio-Electronic service work for either the novice or professional serviceman—bar none! Ask anyone in the business! Read from the beginning, it is a COMPLETE COURSE IN SERVICING by the most modern methods. Used for reference, it is an invaluable means of brushing up on any servicing problems that puzzle you.

### EVERYTHING ABOUT TEST INSTRUMENTS, TROUBLESHOOTING, REPAIR

Gives complete information on all types of test instruments; how they work (with wiring diagrams); When, How and Why to use them; how to build your own; preliminary trouble checks; circuits and parts analysis; parts repair, replacement, substitution; obscure troubles; aligning and neutralizing—and hundreds of other subjects including How to Start Your Own Successful Radio-Electronic Service Business. 706 self-testing review questions help you check your progress every step of the way. 706 illustrations and diagrams. \$5 complete (\$5.50 foreign). 5-DAY MONEY-BACK GUARANTEE. See our Money-Saving Combination Offer in coupon.

## ALL THE SCIENCE OF BASIC RADIO-ELECTRONICS in one big 3½ lb. Book

For Beginners—36 Courses In One

Here is the big book that makes it easy for beginners to start in the fascinating field of Radio-Electronics! Actually, A. A. Ghirardi's 972-page RADIO PHYSICS COURSE book gives you just the basic training you need—ALL YOU NEED—easier, better, faster—for ONLY \$5 COMPLETE. Actually, this giant book is 36 courses in one. If sold in monthly lessons, you'd regard it as a BARGAIN AT \$50 OR MORE!

You'll be surprised how easily RADIO PHYSICS COURSE helps you master subjects that other courses make seem very complicated.

You'll be delighted how soon it will have you doing experiments, building equipment, etc. Step by step it carries you from the very beginning through Basic Electricity to the most modern Radio-Electronic developments. Hundreds of readers have completed it in a few weeks. All you need is a little reading time plus a desire to get started now for a better paying future in broadcasting, aviation radio, F-M, Television, radio servicing, manufacturing—or other fast-growing Radio-Electronic branches. 5-DAY UNRESERVED MONEY-BACK GUARANTEE!

**Radio's Greatest Training Buy!**

## THIS AUTOMATIC TEACHER SHOWS EXACTLY HOW TO REPAIR OVER 4,800 DIFFERENT MODELS!

Ghirardi's big RADIO TROUBLESHOOTER'S HANDBOOK is the ideal manual to show you exactly how to repair radios quickly, without a lot of previous experience and without costly equipment. This 744-page manual-size HANDBOOK brings you specific repair data for the common faults that account for almost 90% of ALL troubles in practically every radio in use today! You don't study it. Simply look up the make, model, and trouble symptom of the Radio you want to repair. No lost time! Clear instructions tell you exactly what the trouble is likely to be, exactly how to fix it.

Specific instructions cover over 4,800 of the most popular models of Home and Auto-radio receivers and Automatic Radio Changers of 202 manufacturers!

Also, RADIO TROUBLESHOOTER'S HANDBOOK has hundreds of additional pages of repair charts, tube charts, data on tuning alignment, transformer troubles, tube and parts substitution, etc., etc., all designed to help you repair all makes and models of radios, faster, and more profitably! Only \$5 (\$5.50 foreign). FIVE DAY UNRESERVED MONEY-BACK GUARANTEE!

**Make Money in Your Spare Time!**

## 5-DAY MONEY-BACK GUARANTEE

Technical Division, MURRAY HILL BOOKS, INC.  
Dept. RC-96, 232 Madison Ave., New York 16, N. Y.

Enclosed find \$..... for books checked; or  send C.O.D. (in U.S.A. only) for this amount plus postage. If not fully satisfied, I may return the books within 5 days and receive my money back.

RADIO PHYSICS COURSE. \$5 (\$5.50 foreign).

RADIO TROUBLESHOOTER'S HANDBOOK. \$5 (\$5.50 foreign).

MODERN RADIO SERVICING. \$5 (\$5.50 foreign).

MONEY-SAVING COMBINATION: MODERN RADIO SERVICING and RADIO TROUBLESHOOTER'S HANDBOOK (both books) only \$9.50 (\$10.50 foreign).

Name .....

Address .....

City & Dist. No. .... State .....

## THE WORLD'S GREATEST RADIO-ELECTRONIC TRAINING BARGAINS!

# 1946 MODELS JUST ARRIVED SUPERIOR INSTRUMENTS IMMEDIATE DELIVERY

## The New Model 705 SIGNAL GENERATOR



### RANGES:

From 95 kc to 100 mc, continuously variable. Calibration accurate to 2% through broadcast bands, within 3% for high frequency bands. Planetary drive condenser, direct reading calibration, output modulated or unmodulated. Self-contained electronic modulation 400c sine wave available for external use. Special feature provided in having two degrees of modulation at both approx. 30% and 80%.

YOUR COST ..... \$49.50



## The New Superior Model CA-11 Signal Tracer

Net Price \$18.75

### FEATURES:

- ★ Signal intensity readings are indicated directly on the meter.
- ★ Only one connecting cable—No tuning controls.
- ★ Highly sensitive—uses an improved vacuum tube voltmeter circuit.

- ★ Tube and resistor-capacity network are built into the Detector Probe.
- ★ Completely portable — weighs 5 lbs. Measures 5 x 6 x 7 inches.
- ★ Provision is made for insertion of Phones.

YOUR COST ..... \$18.95



## The New Model 680 5000 Ohms per Volt VOLT-OHM MILLIAM- METER

Net Price .... \$27.65

A single scale is used for all voltage (both A.C. and D.C.) and current ranges. Thus all readings are plain and obvious. Radio servicemen will be delighted with this time-saving innovation. Measures: D.C. VOLTAGES to 1500 volts; A.C. VOLT-

AGES to 1500 volts; RESISTANCE to 2 megohms; OUTPUT VOLTS to 1500 volts; D.C. CURRENT to 150 MA; DECIBELS to +58 D.C. Housed in hand-rubbed oak, portable cabinet. Complete with self-contained battery, test leads and instructions.

YOUR COST ..... \$27.65

Terms: 10% Deposit with Order—Balance C.O.D.

**LIBERTY SALES CO., INC.**  
115 WEST BROADWAY · NEW YORK 13, N. Y.

# NEW RADIO-ELECTRONIC DEVICES

## PRECISION SCOPE

Browning Laboratories, Inc.  
Winchester, Mass.

The Model OL-15 is a precision, multi-purpose oscilloscope using a five-inch tube.

The response curve of the vertical amplifier is linear and without positive slope from 10 cycles to well over four megacycles. The horizontal amplifier response extends linearly from 10 cycles to over one megacycle to accommodate any type of externally generated sweep voltage. The sawtooth sweep range is from five cycles to 500 kilocycles.

Triggered sweeps of one, four, 20 and 200 microseconds per inch may be in-



augurated by the internal trigger generator or by external pulses.

The scope is 15 1/4 x 12 3/4 x 19 1/4 inches and weighs less than 85 pounds.—  
RADIO-CRAFT

## AMATEUR TRANSMITTER

Transmitter Engineering Mfg. Co.  
New York, N. Y.

The Temco Model 75-GA transmitter is designed for 75 watt phone—100 watt cw operation on the 3.5, 7, 14, 21 and 28 mc amateur bands.

V.F.O. or crystal control are optional with front-panel switching. The 80-meter v.f.o. and crystal oscillators are followed by doublers and triplers that are switched into the circuit when the band switch is turned to the operating frequency. The intermediate stages have pre-tuned, broadly resonant plate cir-



cuits which do not require tuning. Push-pull-parallel 6L6's are Class AB2 modulators for the TB35 or 3D23 final amplifier. The speech amplifier works from a high impedance crystal or dynamic mike.

Band changing is by turning the band switch to the desired band and changing the plug-in coil of the PA.

The 75-GA may be used as an exciter for a 500 watt amplifier by linking the plate coil of the PA to the grid circuit of the high power amplifier and replacing the modulation transformer with a driver transformer for the Class B modulators.—RADIO-CRAFT

## VACUUM TUBE VOLTMETER

Radio City Products Co., Inc.  
New York, N. Y.

The new Model 668 Electronic Multi-tester is an a.c.-d.c. volt-ohmmeter and capacity meter designed for industrial and radio servicing. Front-panel controls are provided for zeroing the meter for both a.c. and d.c. readings and for line voltage adjustments.



The ranges are as follows: Six d.c. v.t.v.m. ranges to 6000 volts. Sensitivity 16 to 160 megohms; seven a.c. v.t.v.m. ranges, 16 to 160 megohm sensitivity, 0 to 6000 volts full scale; seven resistance ranges to 1000 megohms; capacity ranges from .00005 to 2000 µf.—RADIO-CRAFT

## Immediate Delivery from Stock

SUPREME 543-S Multimeter .....	\$24.75
SUPREME 589 Tube & Battery Tester ..	48.95
SUPREME 599 Tube & Set Tester .....	62.50
SUPREME 565 Vacuum tube voltmeter ..	63.50
SUPREME 546 Oscilloscope .....	89.75
WATERMAN S-10-A Pocket Size Oscilloscope .....	55.00
DUMONT 274 Five-Inch Oscilloscope ..	99.50
McMURDO SILVER "Sparx" Dynamic Signal Tracer .....	39.90
McMURDO SILVER 904 Capacitance Resistance Bridge .....	49.90
McMURDO SILVER "Vomax" Vacuum Tube Voltmeter .....	59.85
R.C.P. 448 Pocket Multitester .....	24.50
R.C.P. 424A Volt-Ohm-Milliammeter ..	29.50
R.C.P. 322 Tube Tester .....	41.50
R.C.P. 461 AP Sensitive Multitester ..	43.50
R.C.P. 664 Electronic Multimeter .....	45.00
R.C.P. 322P Tube Tester (Portable) ..	45.50
R.C.P. 315 Tube Tester .....	59.50
R.C.P. 668 Vacuum Tube Volt-Ohm- Capacity Meter .....	74.50
R.C.P. 665 A.V.T. Volt-Ohm-resizer Insulation Tester .....	94.50

Write for Free Catalog  
**ATLAS ELECTRONICS COMPANY**

Dept. C9, 11 Edward M. Morgan Pl., N. Y. 32, N. Y.

**MOST -  
OFTEN -  
NEEDED**

# RADIO DIAGRAMS

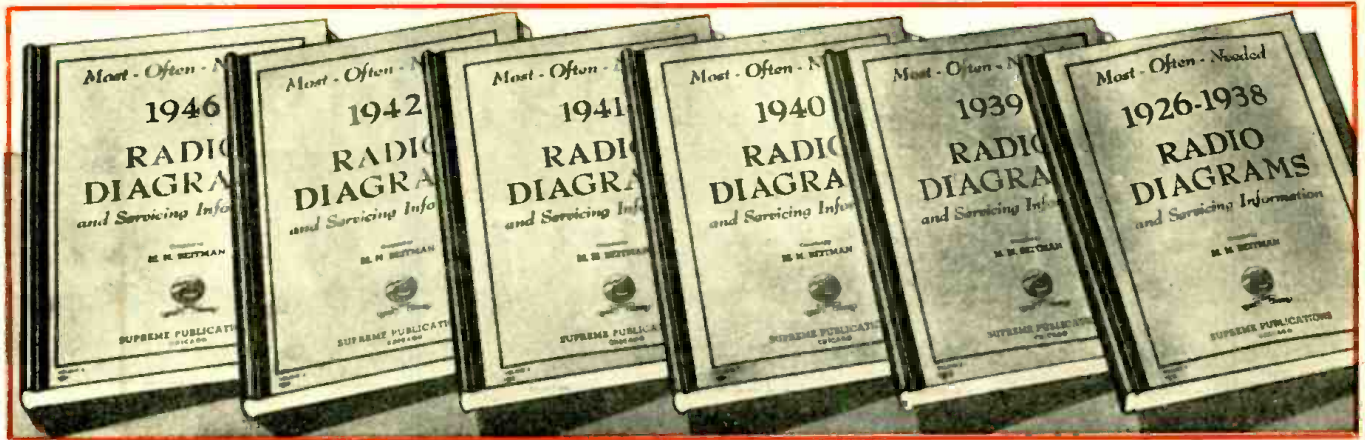

## 1946 4 Out of 5 Diagrams You Will Ever Need

Find radio faults quickly. Make the needed repairs in any new radio. Save time on every job. This large, new, and inexpensive diagram manual has the circuit for almost every 1946 radio set made since V-J day. Large manual, 8 1/4 x 11 inches, 192 pages of circuits and repair data. Price postpaid, only **\$2.00**

## 1942 Clearly printed circuits, alignment data, parts lists, service hints are the facts you need to speed up all radio servicing. Repair radios quickly and properly—follow the factory instructions given. Includes 351 models of 40 largest manufacturers. 192 fact packed pages. Large size, 8 1/2 x 11 in. Manual style binding. Well printed. Price postpaid, only **\$2.00**

Clearly printed circuits, alignment data, parts lists, service hints are the facts you need to speed up all radio servicing. Repair radios quickly and properly—follow the factory instructions given. Includes 351 models of 40 largest manufacturers. 192 fact packed pages. Large size, 8 1/2 x 11 in. Manual style binding. Well printed. Price postpaid, only **\$2.00**

## NEW, POPULAR, LOW-PRICED MANUALS

### 1941

You need these easy-to-apply, inexpensive manuals to help you repair radios faster. This volume covers 1941 models, with alignment data, I.F. peaks, and replacement parts lists. Compiled by M. N. Beitman, radio serviceman for many years, author, and teacher. Be an expert in radio servicing; simplify your work. 192 pages 8 1/2 x 11 inches. Only **\$2.00**

### 1940

Let this important manual give you over 80% of all 1940 circuits you will ever need, acquaint you with new developments, train you to service quickly and efficiently millions of sets. Data on portables, recorders, FM, etc. 417 models of 43 manufacturers. 208 pages. Net price **\$2.00**

### 1939

Another handy manual of the most popular diagrams you need. Circuit data, hints and information are time-savers and money-makers for you. Let these diagram manuals guide you to easier service work. Why try to get along without helpful diagrams? Use this volume with 192 pages of diagrams of 39 makes. Only **\$2.00**

**Most Popular Models Made by:**  
R.C.A., Zenith, Philco, Sears, Fada, Emerson, Belmont, Detrola Radio, United Motors, G.E., Westinghouse, Arvin, Majestic, Stewart-Warner, Admiral, Delco, Stromberg-Carlson, Western Auto, Spartan, Motorola, Wards, Gamble, and many others.

## Other Practical Radio Manuals

### RADIO SERVICING COURSE



Let this 22-lesson course help you fix and adjust any radio set. Easy-to-understand explanations: hundreds of simplified diagrams, pictures, practical hints. Quickly learn how to make needed tests, locate faults, complete the repair. Learn new speed-tricks of radio fault finding, case histories of common troubles, servicing short cuts, extra profit ideas. Many active servicemen used this reduced price radio training for brush-up and study of new service methods. Large size: 8 1/2 x 11 inches. 22 lessons, 224 pages. **\$2.50**  
Hundreds of diagrams, illustrations, charts.

- ★ STEWART-WARNER MANUAL . . . . . 50c
- ★ ARVIN DIAGRAM MANUAL . . . . . 50c
- ★ GENERAL-ELECTRIC MANUAL . . . . . 50c  
64 pages of popular circuits. Size: 5 1/2 x 8 1/2 inches

### PRACTICAL RADIO MATHEMATICS



Introduces and explains the use of arithmetic and elementary algebra in connection with units, color code, meter scales, Ohm's Law, alternating currents, ohmmeter testing, wattage rating, circuits, series and parallel connections, capacity, inductance, mixed circuits, vacuum tubes, curves, the decibel, etc., etc., and has numerous examples. Bargain price, only **25c**

## 1926-1938

The most popular volume of the series. Will pay for itself with the time saved during the first day of use. Includes all the popular old timers. Save hours on every job. 427 diagrams of the most serviced radios of this period, with parts lists and alignment information. 240 pages, 8 1/2 x 11 inches. Sold with a money back guarantee. Price, postpaid, **\$2.50**



Compiled by M. N. Beitman, radio engineer, teacher, author & serviceman.

## SAVE HOURS ON EVERY JOB

Be ready to make repairs in minutes instead of hours. You will be called upon to fix hundreds of models listed in these easy-to-use manuals. Tackle each job with the needed help found on every page in these handy service manuals. Greatest bargain in diagram books. Send your order today. Use these manuals this week.

## NO RISK TRIAL ORDER COUPON

SUPREME PUBLICATIONS, 9 S. Kedzie Ave., Chicago 12, ILL.  
Ship the following manuals: (Money back guaranteed)

- 1946    1942    1941    1940    1939    1926-1938  
 Radio Servicing Course    Stewart-Warner    Arvin  
 General-Electric Manual    Radio Mathematics

- I am enclosing \$.....send postpaid.  
 Send C.O.D. I am enclosing \$..... deposit.

Name: .....

Address: .....

(Use Coupon or Write Order in a Separate Letter)

See Your Radio Jobber or Send Coupon→

# Supreme Publications

PUBLISHERS OF RADIO BOOKS, MANUALS, AND DIAGRAMS

# 308 SPRAGUE DISTRIBUTORS TO SERVE YOU



So many users of the SPRAGUE TRADING POST, our free wartime advertising service, have asked for the names of their nearest Sprague distributors that—well, here's the entire list. These firms will supply you with factory-fresh Sprague Capacitors and Koolohm Resistors of the very latest types. They'll be only too glad to serve you.

THE SPRAGUE TRADING POST did its part during the war. Now, both Sprague and its distributors will "follow through" by bringing radio servicemen, amateurs and experimenters the finest components backed with the best service obtainable.

As always, we'll appreciate it if you continue to: "Ask for Sprague Capacitors and Koolohm Resistors by name!"

SPRAGUE PRODUCTS CO., North Adams, Mass.

Jobbing Distributing Organization for Products of the Sprague Electric Company



◀ ASK YOUR JOBBER for a copy of the big new Sprague Catalog. Gives full details on the most complete Capacitor line on the market—also Koolohm Resistors and the famous Sprague Tel-Ohmike Analyzer.

SPRAGUE CAPACITORS are specified by part numbers in the popular new HOWARD W. SAMS PHOTO FACT FOLIOS



# SPRAGUE CAPACITORS . . . . .



# Ask for Sprague Products by Name!

## ALABAMA

Bessemer—Bessemer Radio Supply  
Birmingham—James W. Clary  
Mobile—Nelson Radio & Supply Co.  
Radio Labs  
Montgomery—Teague Hardware Co.  
Southeastern Radio Parts Co.

## ARKANSAS

Fort Smith—Wise Radio Supply  
Little Rock—Southern Radio Supply  
Texarkana—Lavender Radio Supply Co.

## ARIZONA

Phoenix—Radio Parts of Arizona

## CALIFORNIA

Bakersfield—Bakersfield Radio Supply  
Fresno—Jack C. Ar buckle  
Billings Wholesale Radio  
Hollywood—Hollywood Radio Supply, Inc.  
Long Beach—Radio & Tel. Equip. Co.  
Los Angeles—Figart Radio Supply Co.  
Kierulff & Co.  
Nelson Brothers Co.  
Radio Equip. Distributors  
United Radio Supply Co.  
Universal Radio Supply Co.  
Modesto—Jack Warren  
Oakland—W. D. Brill Company  
E. C. Wenger Co.  
Pasadena—Dow Radio Supply Co.  
Sacramento—C. C. Brown Co.  
Henderson Bros.  
Sacramento Elec. Supply Co.  
San Diego—Coast Electric Co.  
Electronic Equip. Distr.  
Shanks & Wright  
San Francisco—Associated Radio Dists.  
C. C. Brown Co.  
San Jose—Frank Quement  
Santa Ana—Radio & Tel. Equip. Co.

## COLORADO

Denver—Inter-State Radio & Supply Co.

## CONNECTICUT

Bridgewater—Hatry & Young, Inc.  
Hartford—Hatry & Young, Inc.  
New Britain—United Radio Supply  
Universal Radio Co.  
New Haven—Thomas H. Brown Co.  
Hatry & Young, Inc.  
New London—Hatry & Young of New  
London, Inc.  
Stamford—Hatry & Young, Inc.  
Waterbury—Hatry & Young, Inc.

## DELAWARE

Wilmington—Radio Elec. Serv. Co.

## DISTRICT OF COLUMBIA

Washington—Kenyon Radio Supply Co.  
Rucker Radio Wholesalers

## FLORIDA

Jacksonville—Kinkade Radio Supply  
Major Appliances  
Miami—Electronic Supply Co.  
Major Appliances  
Orlando—Radio Accessories Co.  
St. Petersburg—Welch Radio Supply  
Sarasota—Mortley Radio Co.  
Tampa—Kinkade Radio Supply  
Major Appliances

## GEORGIA

Atlanta—Concord Radio Corp.  
Southeastern Radio Parts Co.  
Specialty Dstg. Co., Inc.  
Macon—Specialty Dstg. Co., Inc.  
Savannah—Southeastern Radio Parts Co.  
Specialty Dstg. Co., Inc.

## ILLINOIS

Bloomington—J. W. Arbuckle  
Chicago—Allied Radio Corp.  
Concord Radio Corp.  
Grant Radio Co., Inc.  
Nation Wide Radio  
Radio Parts Company  
Kankakee—Radio Doctors Supply House

## INDIANA

Angola—Lakeland Radio Supply  
Richmond—Fox Sound Equipment Co.

## IOWA

Cedar Rapids—Gifford-Brown, Inc.  
Council Bluffs—World Radio Labs., Inc.  
Des Moines—Gifford-Brown, Inc.  
Radio Trade Supply Corp.  
Fort Dodge—Gifford-Brown, Inc.  
Ken-Els Radio Supply  
Mason City—Radio-Electric Supply Co.  
Sioux City—Power City Radio Company  
Sioux City Radio & Appl. Co.  
Waterloo—Gifford-Brown, Inc.  
World Radio Laboratories, Inc.

## KANSAS

Pittsburg—Pittsburg Radio Supply  
Topeka—Acme Radio Supply  
Wichita—Radio Supply Co.

## KENTUCKY

Lexington—Radio Equipment Co.  
Louisville—Peerless Electronic Equip. Co.  
Newport—Apex Distributing Co.

## LOUISIANA

Lake Providence—F. H. Schneider & Sons, Inc.  
New Orleans—Radio Parts, Inc.  
Shreveport—Dunkelman-Pace  
Koelemay Sales Co.

## MAINE

Auburn—Radio Service & Supply Store  
Portland—Frank M. Brown Co.

## MARYLAND

Baltimore—Henry O. Berman Co., Inc.  
Cumberland—Cumberland Radio Whol.  
Salisbury—Dealers Radio Service

## MASSACHUSETTS

Boston—De Mambro Dstrs., Inc.  
Hatry & Young of Mass., Inc.  
A. W. Mayer Co.  
Radio Wire Television, Inc.  
Sager Elec'l Supply Co.  
Cambridge—The Eastern Co.  
Holyoke—Springfield Radio Co.  
Lawrence—Hatry & Young of Mass., Inc.  
New Bedford—C. E. Beckman Co.  
Pittsfield—Pittsfield Radio Co.  
Roxbury—Gerber Radio Supply Co.  
Springfield—T. F. Cushing Co.  
Springfield Radio Co.  
Worcester—De Mambro Dstrs., Inc.  
The Eastern Co.  
Radio Electronic Sales Co.  
Radio Maintenance Supply Co.

## MICHIGAN

Ann Arbor—Wedemeyer Elec. Supply Co.  
Battle Creek—Wedemeyer Elec. Supply Co.  
Detroit—Ferguson Radio Supplies  
Radio Specialties Co.  
Radio Supply & Eng. Co., Inc.  
Flint—Radio Tube Mds g. Co.  
Grand Rapids—Wholesale Radio Co.  
Jackson—Fulton Radio Supply  
Kalamazoo—Ralph M. Ralston Co.  
Muskegon—Industrial Elec. Supply Co.  
Pontiac—Electronic Supply Co.  
Saginaw—Radio Parts Company

## MINNESOTA

Duluth—Northwest Radio  
Minneapolis—Bauman Company  
Sidney Rosenthal  
St. Paul—Electronic Distributing Co.

## MISSISSIPPI

Greenville—The Goyer Company  
Meridian—Griffin Radio Supply

## MISSOURI

Cape Girardeau—Suedekum Elec. Sup. Co.  
Jefferson City—Central Mo. Dstg. Co.  
Joplin—M. Brotherson  
Mardick Dstg. Co.  
Kansas City—Burststein-Applebee Co.  
Manhattan Corp.  
St. Joseph—St. Joseph Radio & Supply Co.  
St. Louis—Walter Ashe Radio Co.  
Interstate Supply Co.  
Radonics  
Springfield—Harry Reed Radio & Sup. Co.

## MONTANA

Butte—George Steele & Co.  
Kalispell—McIntosh Music House

## NEBRASKA

Omaha—Omaha Appliance Co.  
Radio Equipment Co.  
Scottsbluff—Joachim Radio Supply

## NEW HAMPSHIRE

Dover—American Radio Corp.

## NEW JERSEY

Camden—Radio Elec. Serv. Co.  
Newark—Continental Sales Co.  
Krich-Radisco, Inc.  
T. A. O'Loughlin & Co.  
Radio Wire Tel., Inc.  
Perth Amboy—Bennett's Radio Supply  
Red Bank—J. H. Kelly Company  
Trenton—United Tire Stores Co.

## NEW YORK

Albany—Fort Orange Radio Dstg. Co.  
Amsterdam—Adirondack Radio Supply  
Auburn—Dare's Radio Service  
Binghamton—Broome Dstg. Co., Inc.  
Federal Radio Supply Co.  
Brooklyn—Green Radio Distributors  
Scan-Burn Radio & Elec. Co.  
Buffalo—Bars Radio & Electronic Parts  
Dymac, Inc.  
Genesee Radio & Parts Co.  
Radio Equipment Corp.  
Standard Electronics Co.  
Elmira—LeValley-McLeod-Kinkaid Co., Inc.  
Fredonia—C. R. Barker  
Glens Falls—Ray Distributing Co.  
Hempstead, L. I.—Standard Parts Corp.  
Ithaca—Stallman of Ithaca  
Jamaica, L. I.—Norman Radio Dists.  
Middletown—L & S Radio Sales  
New York City—Fischer Distributing Co.  
Radiocine Equipment Co.  
Radio Wire Tel., Inc.  
Niagara Falls—Niagara Radio & Parts Co.  
Rochester—Beaucaire, Inc.  
Masline Radio & Electronic Equip. Co.  
Schenectady—Fort Orange Radio Dstg. Co.  
M. Schwartz & Son  
Syracuse—Broome Dstg. Co., Inc.  
Syracuse Radio Supply  
Troy—Trojan Radio Co.  
Utica—Beacon Electronic Inc.  
Watertown—Beacon Electronic Inc.

## NORTH CAROLINA

Asheville—Freck Radio & Supply Co.  
Charlotte—Dixie Radio Supply Co.  
Southern Radio Corp.  
Fayetteville—Eastern Radio Supply  
Goldboro—Signal Radio Supply Co.  
Greensboro—Dixie Radio Supply Co.  
Raleigh—Carolina Radio Equip. Co.  
Winston-Salem—C. R. Williams Radio Co.

## NORTH DAKOTA

Fargo—Radio Equipment Co.

## OHIO

Akron—Olson Radio Warehouse  
Ashabula—Morrison Radio Supply  
Canton—Armstrong Radio Supply  
Burroughs Radio  
Cincinnati—Chambers Radio Supply Co.  
Schuster Elec. Co.  
United Radio, Inc.  
Cleveland—Goldhamer, Inc.  
Northern Ohio Laboratories  
Winteradio, Inc.  
Columbus—Hughes-Peters, Inc.  
Whitehead Radio Co.  
Dayton—Hughes-Peters, Inc.  
Standard Radio & Electronic Prod. Co.  
East Liverpool—Hausfeld Radio  
Kens—Kladag Radio Labs.  
Lima—The Northwestern Radio Co.  
Mansfield—Burroughs Radio  
Marion—Bell Radio Supply  
Springfield—Standard Radio & Electronic  
Prod. Co.  
Steubenville—D & R Radio Supply  
Hausfeld Radio  
Toledo—Toledo Radio Specialties  
Warren—Radio Specialties  
Youngstown—Appliance Wholesalers

## OKLAHOMA

Enid—Standard Measuring & Equip. Co.  
Oklahoma City—Radio Supply, Inc.  
Southern Sales Co.  
Tulsa—Radio, Inc.

## OREGON

Portland—Bargel Supply  
Harper-Meggee, Inc.  
Portland Radio Supply Co.

## PENNSYLVANIA

Allentown—Radio Elec. Serv. Co.  
Beaver Falls—Reliable Motor Parts Co.  
Easton—Radio Elec. Serv. Co.  
Erie—John V. Duncombe Co.  
Harrisburg—Radio Distributing Co.  
Lancaster—Eshelman Supply Co.  
George D. Barbey Co.  
Norristown—Kratz Bros. Co.  
Philadelphia—Almo Radio Company  
Consolidated Radio Corp.  
Electric Warehouse  
Emerson Radio of Pa.  
Radio Elec. Serv. Co.  
N. W. Cor. 7th & Arch Sts.  
3133 Market St.  
3145 N. Broad St.  
Eugene G. Wile  
Pittsburg—Hamburg Bros.  
The John Marshall Co.  
Radio Parts Co.  
Pottsville—Jones Radio Co.  
Reading—George D. Barbey Co.  
St. Marys—B & R Electric Co.  
Scranton—Broome Dstg. Co., Inc.  
Wilkes-Barre—General Radio & Elec. Co.  
Radio Service Co.  
Williamsport—Williamsport Radio Supply

## RHODE ISLAND

Providence—William Dandreta & Co.  
W. H. Edwards Co.

## SOUTH CAROLINA

Columbia—Dixie Radio Supply Co.

## SOUTH DAKOTA

Aberdeen—Danielson & Brost Co.  
Sioux Falls—Power City Radio Co.  
United Radio Supply

## TENNESSEE

Knoxville—Bomar's  
Chemcity Radio & Elec. Co.  
C. M. McClung & Co.  
Memphis—McTyler Radio Supply  
Nashville—Curry's Radio Service  
Radio & Appliance Corp.

## TEXAS

Abilene—R & R Supply Co., Inc.  
Amarillo—R & R Supply Co., Inc.  
Austin—The Hargis Company  
Beaumont—Montague Radio Co.  
Corpus Christi—Wicks-DeVilbiss Co.  
Electronic Equip. & Engin. Co.  
Dallas—All-State Dstg. Co.  
Crabtree's Wholesale Radio  
Southwest Radio Supply  
Wanslow & Co.  
Fort Worth—Electronic Equipment Co.  
Fort Worth Radio Supply Co.  
Houston—A. R. Beyer Company  
Lubbock—R & R Supply Co., Inc.  
San Antonio—Olsen Radio Supply  
Tyler—Lavender Radio Supply Co.  
Waco—The Hargis Company  
Wichita Falls—Wichita Falls Bat. & Elec.

## VIRGINIA

Norfolk—Ashman Distr. Company  
Roanoke—Leonard Elec. Sup. Co.  
Richmond—Johnson Gasser Co.

## WASHINGTON

Bellingham—Waikus Supply Co.  
Seattle—General Radio, Inc.  
Harper-Meggee, Inc.  
Sunset Electric Co.  
Spokane—Harper-Meggee, Inc.  
Tacoma—Wible Radio Supply

## WEST VIRGINIA

Bluefield—Whitehead Radio Co.  
Charleson—Chemcity Radio & Elec. Co.  
Hicks Radio Supply  
Clarksburg—Trenton Radio Co.  
Huntington—Electronic Supply, Inc.  
Morgantown—Trenton Radio Co.  
Parkerburg—Randle & Hornbrook  
Wheeling—Wheeling Radio Supply

## WISCONSIN

Green Bay—Neslo Electronic Dstrs.  
Madison—Radio Dstrs. of Madison, Wis.  
Milwaukee—Radio Parts Co., Inc.

# .. \* KOOLOHM RESISTORS

\*REG. U. S. PAT. OFF.

**RADIO STORES  
SELLING....**

**RADIO  
CRAFT**

**IN YOUR  
HOME TOWN**

**ALABAMA**  
*Montgomery*  
Teague Hardware Co.  
200 Commerce St.

**ARIZONA**  
*Phoenix*  
Radio Specialties & Appl. Co.  
401 W. Jackson St.

**ARKANSAS**  
*Little Rock*  
Southern Radio Supply  
409 West Third St.

**CALIFORNIA**  
*Bakersfield*  
Bakersfield Radio Supply  
2808 Chester Ave.  
*Hollywood*  
Yale Radio Electric Co.  
6616 Sunset Blvd.  
*Los Angeles*  
General News Agency  
326 West 5th St.  
Papel Bros.  
2639 E. 4th St.  
*San Bernardino*  
George H. Bagley Co.  
1216 D St.  
*San Diego*  
Western Radio & Electric Co.  
1415 India St.  
*San Francisco*  
Associated Radio Dist.  
1251 Folsom St.  
*San Jose*  
Frank Quement Wholesale Radio  
156 W. San Fernando St.  
*Santa Ana*  
Radio & Television Equip. Co.  
207 Oak St.

**COLORADO**  
*Del Norte*  
Valley Music & Electric Co.  
*Denver*  
McGee Radio & Elect. Co.  
1330 Broadway  
Radio Products Sales Co.  
1237 16th St.

**CONNECTICUT**  
*Bridgeport*  
Coastal Radio Service Co.  
1559 Stratford Ave.  
*New Britain*  
United Radio Supply  
53 E. Main St.

**DISTRICT OF COLUMBIA**  
*Washington*  
Capitol Radio Wholesalers  
2120-14 St., N.W.  
Sun Radio  
938 N.W. F St.

**FLORIDA**  
*Jacksonville*  
Radio Parts Co.  
712 Main St.  
Thurou Distributors, Inc.  
806 Main St.  
*Miami*  
Thurou Distributors, Inc.  
420 S. W. 8th Ave.  
*Orlando*  
Thurou Distributors, Inc.  
131 South Court St.  
*Tallahassee*  
Thurou Distributors, Inc.  
213 E. Tennessee  
*Tampa*  
Thurou Distributors, Inc.  
115-117 So. Franklin St.  
*West Palm Beach*  
Thurou Distributors, Inc.  
209 No. Olive St.

**ILLINOIS**  
*Danville*  
Allen Electric Co. Radio Supply  
109 N. Hazel St.  
*Chicago*  
Allied Radio Corp.  
833 W. Jackson Blvd.  
American Parts, Inc.  
610 W. Randolph St.  
Concord Radio Corp.  
901 W. Jackson Blvd.  
Lake Radio Sales Co.  
615 W. Randolph St.  
Radio Shack  
630 W. Randolph St.  
Radolek Company  
601 W. Randolph St.

**INDIANA**  
*Evansville*  
Castrup's Radio Supplies  
1014 W. Franklin St.  
Montoux Auto & Machine Co.  
517 Locust St.  
*Hammond*  
Stanton Radio Supply  
521 State St.  
*South Bend*  
Commercial Sound & Radio Co.  
528 E. Colfax Ave.

**IOWA**  
*Burlington*  
Union Supply Co.  
4th & Washington Sts.  
*Council Bluffs*  
World Radio Labs.  
*Dubuque*  
Boe Distributing Co.  
498 N. Grandview  
*Sioux City*  
Dukes Radio Co.  
114 West 4th St.  
Power City Radio Co.  
513 7th St.

**KANSAS**  
*Pittsburgh*  
Pittsburgh Radio Supply Co.  
103 N. Broadway  
*Topeka*  
Acme Radio Supply  
516 Quincy St.  
*Wichita*  
Interstate Distributors, Inc.  
1236 E. Douglas  
Radio Supply, Inc.  
1125-27 E. Douglas

**KENTUCKY**  
*Lexington*  
Radio Equipment Co.  
377 East Main St.

**LOUISIANA**  
*Monroe*  
Hale & McNeil  
301 Pine St.  
*New Orleans*  
Radio Parts, Inc.  
807 Howard Ave.  
Walther Bros. Co.  
714 Howard Ave.

**MAINE**  
*Bangor*  
Radio Service Laboratory  
45 Haymarket Sq.

**MARYLAND**  
*Baltimore*  
Henry O. Berman Co., Inc.  
12 E. Lombard St.  
Wholesale Radio Parts Co., Inc.  
311 W. Baltimore St.

**MASSACHUSETTS**  
*Boston*  
Sager Electrical Supply Co.  
201 Congress St.  
*Melrose*  
Melrose Sales Co.  
407 Franklin St.  
*New Bedford*  
C. E. Beckman Co.  
Commercial St.  
*Springfield*  
Springfield Radio Co., Inc.  
405 Dwight St.  
*Worcester*  
Radio Electronic Sales Co.  
46 Chandler St.

**MICHIGAN**  
*Ann Arbor*  
Purchase Radio & Camera Shop  
605 Church St.  
*Detroit*  
Hershel Radio  
3249 Grand River Ave.  
Radio Supply & Eng'ring Co., Inc.  
129 Selden Ave.  
*Flint*  
Radio Tube Mfg. Co.  
508 Clifford  
*Jackson*  
Fulton Radio Supply Co.  
707 S. Blackstone St.  
*Lansing*  
Electric Products Sales Co.  
427 E. Michigan Ave.  
*Saginaw*  
Orem Distributing Co.  
801 E. Genesee Ave.  
Radio Parts Co.  
234 S. Second St.

**MINNESOTA**  
*Duluth*  
Northwest Radio  
109 E. First St.

**MISSOURI**  
*Cape Girardeau*  
Suedakum Electronic Supply Co.  
902 S. Spring St.

**NEBRASKA**  
*Omaha*  
Alco Radio, Inc.  
411 Cumins St.  
All-State Distributing Co.  
2857 Farnam St.  
Radio Equipment Co.  
2820-22 Farnum St.

**NEW HAMPSHIRE**  
*Concord*  
Evans Radio  
18 N. Main

**NEW JERSEY**  
*Bridgeton*  
Joe's Radio Shop  
67-69 S. Pearl  
*Newark*  
Radio Wire Television, Inc.  
24 Central Ave.  
Variety Electric Co.  
601 Broad St.  
*Trenton*  
Carl B. Williams  
25 S. Warren St.

**NEW YORK**  
*Binghamton*  
Broome Dist. Co.  
221 Washington St.  
*Brooklyn*  
Green Radio Distributors  
482 Sutter Ave.  
Hornbeam Distributing Co.  
1639 Bedford Ave.  
*Buffalo*  
Dymac, Inc.  
2929-31 Main St.  
Genesee Radio & Parts Co.  
205 E. Genesee St.  
*Jamaica*  
Peerless Radio Dist. Co.  
92-32 Merrick Rd.  
*Middletown*  
Roskin Bros., Inc.  
23 W. Main St.  
*Mount Vernon*  
Davis Radio Dist. Co.  
68-70 E. 3rd St.  
*New York City*  
Federated Purchaser, Inc.  
80 Park Place  
Grand Central Radio, Inc.  
124 E. 44th St.  
Harrison Radio Corp.  
12 West Broadway  
Harvey Radio Co.  
105 W. 43rd St.  
Niagara Radio Supply Corp.  
160 Greenwich St.  
Radio Wire Television, Inc.  
100 Sixth Ave.  
TAB  
6 Church St.  
*Rochester*  
Masline Radio & Electric Equipment  
192-196 Clinton Ave., N.  
*Syracuse*  
Broome Dist. Co.  
912 Erie Blvd. E.  
Syracuse Radio Supply  
238-40 W. Willow St.

**NORTH CAROLINA**  
*Charlotte*  
Henry V. Dick & Co., Inc.  
311 E. 5th St.  
*Goldshoro*  
Signal Radio Supply  
124 S. James St.

**OHIO**  
*Cincinnati*  
Radio & Refrigeration Supply  
1220-6 Jackson St.  
*Cleveland*  
Northern Ohio Labs.  
2073 West 85th St.  
Radio Surplus Co.  
648 Prospect Ave.  
Winterradio, Inc.  
1458 W. 23th St.  
*Dayton*  
Standard Radio & Elect. Prods.  
135 E. Second St.  
*Steubenville*  
D. & R. Radio Supply  
156 S. 3rd St.

**OKLAHOMA**  
*Oklahoma City*  
Radio Supply, Inc.  
724 N. Hudson, Box 597

**PENNSYLVANIA**  
*Altoona*  
Hollenback's Radio Supply  
2221 8th Ave.  
Kennedy Radio Supply  
1500 Fifth Ave.  
*Beaver Falls*  
Reliable Motor Parts Co.  
1700 7th Ave.  
*Eric*  
Jordan Electronic Co.  
201 W. 4th St.  
*Harrisburg*  
D. & H. Distributing Co., Inc.  
311 S. Cameron St.  
*Lancaster*  
Eshelman Supply Co.  
110 N. Water St.  
*Philadelphia*  
Flanagan Radio Corp.  
N.E. Cor. 7th & Chestnut Sts.  
M & H Sporting Goods Co.  
512 Market St.  
Radio Electronics Service Co.  
7th & Arch Sts.  
*Reading*  
Geo. D. Barbey Co.  
432 Walnut St.

*Scranton*  
Broome Dist. Co.  
26 Lackawanna Ave.  
*Sharon*  
Heiges Bros., Inc.  
73 Central Way  
*York*  
J. R. S. Distributors  
646 W. Market St.

**SOUTH DAKOTA**  
*Sioux Falls*  
Power City Radio Co.  
209 So. First Ave.  
United Radio Supply  
211 W. 10th St.

**TENNESSEE**  
*Nashville*  
Frost Electric Inc.  
1922 West End Ave.

**TEXAS**  
*Dallas*  
Southwest Radio Supply  
1820 N. Harwood  
*Fort Worth*  
Ft. Worth Radio Supply Co.  
1201 Commerce  
The Electronic Equip. Co.  
301 E. 5th St.  
*Houston*  
R. C. & L. F. Hall  
1015 Caroline St.  
*Laredo*  
Radio & Electronics Supply Co.  
1219 Lincoln St.  
*Lubbock*  
R. & R. Supply Co., Inc.  
706 Main St.  
*San Antonio*  
R. L. Ross Co.  
118 Seventh St.  
*Tyler*  
Radio Service Supply Co.  
111 University Place  
*Waco*  
The Hargis Co., Inc.  
1305 Austin Ave.

**UTAH**  
*Salt Lake City*  
O'Loughlin's Radio Supply Co.  
113 East Broadway  
Radio Supply Co.  
45 East 4 South  
Standard Supply Co.  
531 So. State St.

**VIRGINIA**  
*Norfolk*  
Radio Parts Dist. Co.  
128 W. Diney Rd.  
Radio Supply Co.  
711 Granby St.

**WASHINGTON**  
*Bellingham*  
Waikus Supply Co.  
110 Grand Ave.  
*Seattle*  
Harper-Megee  
960 Republican St.  
*Spokane*  
Columbia Electric & Mfg. Co.  
P.O. Box 1441 S. 123 Wall St.  
Inland Radio Co.  
W. 923 First Ave.  
*Tacoma*  
C. & G. Radio Supply Co.  
714 St. Helens Ave.  
A. T. Stewart Co.  
743 Broadway

**WEST VIRGINIA**  
*Clarksburg*  
Trenton Radio Co.  
791-93 W. Pike St.  
*East Charleston*  
Hicks Radio Supply  
10 Virginia St.  
*Parkersburg*  
John A. Cox Radio Supplies  
554 7 St.

**WISCONSIN**  
*Appleton*  
Valley Radio Distributors  
518 N. Appleton St.  
*Hudson*  
J. H. Larson Co.  
109 Walnut St.  
*Madison*  
Satterfield Radio Supply Inc.  
326 W. Gorham St.  
*Milwaukee*  
Acme Radio Supply Corp.  
510 N. State St.  
Central Radio Parts Co.  
1723 West Fond Du Lac Ave.  
*Racine*  
Standard Radio Parts Co.  
1244 State St.

**WYOMING**  
*Casper*  
Golden Power Oil & Supply Co.  
260 S. Center  
*Cheyenne*  
Hogue Radio & Supply Co.  
2008 Carey Ave.

**DEALERS: If you are not receiving RADIO-CRAFT, please ask for our Special Consignment Proposition.**

**NOW AVAILABLE FOR IMMEDIATE SHIPMENT!**



*The New Model 670*  
**SUPER-METER**

*A Combination*  
**VOLT-OHM MILLIAMMETER**  
plus **CAPACITY REACTANCE**  
**INDUCTANCE** and  
**DECIBEL MEASUREMENTS**

*Added Feature:*

The Model 670 includes a special **GOOD-BAD** scale for checking the quality of electrolytic condensers at a test potential of 150 Volts.

*Specifications:*

**D.C. VOLTS:** 0 to 7.5/15/75/150/750/1,500/7,500 Volts  
**A.C. VOLTS:** 0 to 15/30/150/300/1,500/3,000 Volts  
**OUTPUT VOLTS:** 0 to 15/30/150/300/1,500/3,000 Volts  
**D.C. CURRENT:** 0 to 1.5/15/150 Ma. 0 to 1.5 Amperes

**RESISTANCE:** 0 to 500/100,000 ohms 0 to 10 Megohms  
**CAPACITY:** .001 to .2 Mfd. .1 to 4 Mfd. (Quality test for electrolytics)  
**REACTANCE:** 700 to 27,000 Ohms 13,000 Ohms to 3 Megohms  
**INDUCTANCE:** 1.75 to 70 Henries 35 to 8,000 Henries  
**DECIBELS:** -10 to +18 +10 to +38 +30 to +58

*The Model 670 comes housed in a rugged, crackle-finished steel cabinet complete with test leads and operating instructions. Size 5½" x 7½" x 3".*

**\$2840**  
NET

*Model 670P*

The Model 670P is identical to the Model 670 described in detail except housed in a hand-rubbed, portable oak cabinet complete with cover.

The Model 670P comes complete with test leads and all operating instructions.

**\$35<sup>75</sup>**  
NET



Please place your order with your regular radio parts jobber. If your local jobber cannot supply you, kindly write for a list of jobbers in your State who do distribute our instruments or send your order directly to us.



**SUPERIOR INSTRUMENTS CO.**

**Dept. R**

**227 FULTON ST., NEW YORK 7, N. Y.**

# See This NEW Book for 7 Days FREE

## JUST OFF THE PRESS



VALUABLE HELPS FOR RADIO ENGINEERS



HELPFUL DATA ON RADIO CONTROL & MAINTENANCE



DIAGRAMS, TABLES, CHARTS TO AID RADIO REPAIRMEN



# RADIOMAN'S HANDBOOK

**A New, Valuable Book for Men Working in Radio, Electronics, Electricity**

No matter what work you do in radio, this handbook will prove mighty valuable since it contains exactly the information you wish, available in an instant. You can refer to it easily right on the job. I'm so sure that you wouldn't part with this book for many times its cost that I'm willing to send it to you for a 7-day FREE examination.

## USE IT DAILY ON THE JOB

You can't expect to carry all the necessary information you need on a job, in your head. But you CAN have all the information at your side with this handy book. Once you look through the pages of the Radioman's Handbook and see how the tables, charts, diagrams and data can save time and help you get ahead, you will see why this book is as valuable as your other tools.

## HERE'S WHAT THIS GREAT BOOK COVERS

- |                         |   |
|-------------------------|---|
| MATERIALS               | RADIO RESISTANCE & INSULATION (WIRE TABLES, etc.) |
| ABBREVIATIONS           | CAPACITORS & CAPACITANCE                          |
| CIRCUITS                | COILS & COIL WINDING                              |
| POWER FORMULAS          | RESONANCE & COUPLING                              |
| RECEIVING TUBES         | OSCILLATORS & ANTENNAS                            |
| TRANSFORMERS            | RECEIVERS   |
| AMPLIFIERS              |   |
| SOUND SYSTEMS & DEVICES |   |

## THOUSANDS OF FACTS — NOT A TEXTBOOK

Every subject is indexed and condensed to fit in readable space without waste. Over 300 pages packed full of valuable information that will help you in your daily work. When you are "on a spot" just turn to the quick index, look up the subject you want and you'll find that subject thoroughly explained with helpful diagrams and tables. Every diagram has been fully tested in the great Coyne Electrical Shops. Every table is scientifically correct.

## SEND NO MONEY. SEE IT FREE

I am not asking you to send any money—not a single penny. I am so sure this is the book you want and need that I will send it to you to examine for 7 days FREE. Then you look it over and you decide. If it isn't all I claim, then send it back and you owe nothing. If you are convinced that this book is worth many times its cost, then send \$3.25 at the end of 7 days and the book is yours. Send the coupon now, while it is before you!

## 3 OTHER COYNE BOOKS ... SEE THEM FREE



**Electrical & Radio Dictionary and Data Book**  
Contains 3,300 electrical, radio, radar, electronic terms in every energy shop and construction use. Know the meaning of the newest terms. Hand-picked data to help you on job. 300 pages, vest pocket size, 3x5". Flexible cover. Price \$1.50—sent on 7 days' FREE trial. Mail coupon today.



**Electronics for Radio men & Electricians**  
Practical electronics for electricians, radio men, anyone working in radio, television or other electronic fields. It includes a trouble shooting and installation. Full details on basic electronic principles. Hundreds of diagrams. See it free for 7 days, then return and owe nothing or pay only \$4.95. Mail coupon today.



**Electrical & Radio Trouble Shooting Manual**  
All new methods of trouble shooting on electrical, radio, refrigeration, diesel and automotive equipment. 600 wiring diagrams. 612 pages. 1 year free Consultation Service and Technical Bulletins. Only \$9.95 on terms—\$3 in 7 days and \$3 monthly. Cash price \$9.00. See it FREE for 7 days before buying. Mail coupon now.

## FREE TRIAL COUPON

B. W. Cooke, Director, COYNE ELECTRICAL SCHOOL, Dept. 66-T1  
500 S. Paulina Street, Chicago 12, Illinois

Send me the **COYNE RADIOMAN'S HANDBOOK** for 7 days' FREE examination. After 7 days I'll either return the book and owe nothing or I'll send you a check or money order for \$3.25.

Here are other Coyne Books—I'll send any or all on same 7 day Free Examination Offer.

- Coyne Electrical & Radio Trouble Shooting Manual**—1 Volume, \$9.00 cash—\$9.95 on time—\$3.00 after 7 days and \$3.00 monthly—1 year Technical Bulletins Free.
- Coyne Electronics for Radlomen & Electricians**—1 Volume, \$4.95 after 7 days' examination—1 year Free Technical Bulletins.
- Electrical & Radio Dictionary**—vest pocket size, \$1.50 after 7 days.

Name \_\_\_\_\_ Age \_\_\_\_\_

Address \_\_\_\_\_

Town \_\_\_\_\_ Zone \_\_\_\_\_ State \_\_\_\_\_

Where Employed? \_\_\_\_\_

Check here if you prefer to pay postman cash price indicated above when books arrive. Same 7 day examination and money-back guarantee of satisfaction.

**COYNE** Technical Book Division  
**ELECTRICAL SCHOOL**  
500 S. Paulina St., Dept. 66-T1 Chicago 12, Ill.

## IS TELEVISION REALLY HERE?

(Continued from page 821)

mission—as is the case with radio broadcast today—we need a minimum of 1,500 television transmitters. It does not appear that such a program could be possibly realized within even ten years from today. Until such time, mass production of television receivers, to run into the millions, does not seem feasible.

It is true that Westinghouse has proposed their so-called *Stratovision*, whereby a small number of television transmitters, cruising continuously in the stratosphere could blanket the entire country. This, however, is as yet a mere proposal. It is not known if such a scheme is feasible technically and whether or not it could be soon realized. If and when it is and has proven its worth, then, the total number of transmitters and the ten-year estimate mentioned could be cut to a great extent.

For the present, only a few large centers in this country will conceivably be served by television. The programs will have to be more or less mediocre because highly expensive productions must remain completely out of the picture. The reason: *no advertiser is going to spend millions or even hundreds of thousands of dollars to broadcast to a few thousand television receivers.* Today

(Continued on page 855)

## TOP SECRET



This famous portable receiver designed for and used by the U. S. Secret Service overseas is available to you for the first time in **KIT FORM** 6 tubes included. Small, compact, ultra-efficient. No drilling or punching required. Complete wiring diagrams supplied.

- \* Uses 6 Miniature Tubes 1R5-1S5-3-1T4's in a superhot circuit
- \* 2 Band Covers 2-12 Megacycles
- \* Requires 90 Volts B & 1 1/2 Volts A Battery
- \* Iron core (456 K.C.) I.F. Transformers
- \* B.F.O. for CW reception

QUANTITY LIMITED.  
SHIPPING WEIGHT, 4 LBS.  
YOUR COST

**\$19.95**

Less Phones and Hookup Wire

(Additional Information on Request)

**DETECTOPHONE**—Manufactured by **SPEAK-O-PHONE**—Army Surplus—contains highly sensitive 4 tube push-pull audio amplifier, battery operated. Complete with Carrying Case, Tubes, Induction Coil Pickup, Contact Mike, Carbon Mike, Headphones. (Less batteries.)  
Your Cost ..... \$39.50

**WAVE METER**—Field Strength Meter—Small, compact, contains 0-200 Microammeter, 70-90 MC. Can be adapted to any frequency by changing coil ..... \$12.95

**STEPPER RELAYS**—2 pole 10 position Relays—will operate on 21-48 Volts D.C. with normally open holding contact. Automatic Reset coil. Ideal for telephone selector and counting circuits. Your Cost ..... \$6.50

**METERS**—0-200 D.C. MA. 2 1/4" square ..... \$2.95

**STANDARD MFGRS OIL FILLED CONDENSERS**  
1 mfd.—1500 W.V. upright mtg. .... \$1.10  
2 mfd.—1500 W.V. socket hole mtg. .... \$1.65  
2 mfd.—2000 W.V. upright mtg. .... \$1.89

20% Deposit with order—Include postage  
Write For Quantity Prices  
**KELVIN ELECTRONICS**

76 Cortlandt Street, New York 7, N. Y.

**Immediate Shipment!**



# RADIO PARTS ELECTRONIC EQUIPMENT

**New CONCORD Bulletin — FREE! Hundreds of Bargains! Scores of New Items!**

### Hundreds of RADIO and ELECTRONIC NEEDS—Including:

- METERS • CONDENSERS
- RESISTORS • TESTERS
- TRANSFORMERS • TOOLS
- SPEAKERS • AMPLIFIERS
- HAM RECEIVERS & GEAR
- PHONOGRAPHS
- RECORD CHANGERS
- ANTENNAS (AUTO)
- SWITCHES • RELAYS

### Nationally-Known Makes—Including:

- SHURE • ASTATIC
- CORNELL-DUBILIER
- ICA • DUMONT
- SUPREME • TRIPLETT
- G. E. • WEBSTER
- PRESTO • AUDIODISCS
- GARRARD • THORENS
- CRESCENT • SOLAR
- MALLORY • R.C.A.

Ready now! 8 giant-size pages packed with long-awaited Radio and Electronic Parts, Supplies and Equipment—new merchandise, just received—now *in stock* for IMMEDIATE SHIPMENT! See hundreds of items for every Radio and Electronic need—for building, repair, maintenance—for engineer, manufacturer, service man, amateur. Top-quality, standard-made parts (see partial list at left). Includes many new and scarce items—scores of money-saving bargains—all ready for shipment at once from CHICAGO or ATLANTA. Mail the coupon below TODAY for your FREE copy of the new CONCORD Bulletin.



**Did You Receive Your Copy of CONCORD'S NEW COMPLETE CATALOG?**

Showing the latest and greatest selection of guaranteed quality Radio Sets, Phonographs, Radio Parts, Supplies, Equipment, Amateur Gear, Kits—plus the new Multiamp Add-A-Unit Amplifiers—exclusive with CONCORD. If you do not have the new COMPLETE CONCORD Catalog, check coupon below.

**CONCORD RADIO CORPORATION**  
901 W. Jackson Blvd., Dept. RC-96, Chicago 7, Ill.  
Please rush my FREE COPY of the new Concord Bulletin of Radio Parts.  
 (Check if you also want new Complete Concord Radio Catalog).

Name.....  
Address.....  
City..... State.....

**CONCORD**  
RADIO CORPORATION  
LAFAYETTE RADIO CORPORATION  
CHICAGO 7 ATLANTA 3  
901 W. Jackson Blvd. 265 Peachtree Street

# RADIO-ELECTRONIC CIRCUITS

## MONO-BATTERY RADIO

This simple receiver does not work well on distant stations but "locals" are pulled in with plenty of volume. Several different tubes have been tried but the 71-A seems to give the best results. No B battery is used and the plate is operated at ground potential. Although the 71-A operates normally with 5 volts on the filament, optimum performance is obtained with only 3 volts.

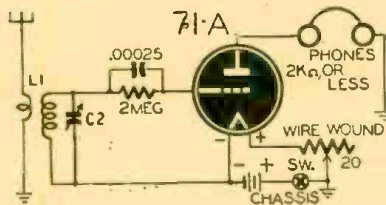

The tuning condenser and coil may be salvaged from an old broadcast receiver.

EUGENE SKINNER,  
Wilton, N. Dak.

(Note: Operation and performance of this unusual circuit will probably be similar to that of a crystal receiver. We would be interested in receiving comments from readers who build this set.—Editor)

## NOVEL RADIO-INTERCOM

A small home receiver may be converted to a handy intercommunicator unit with the addition of a few simple parts.

The receiver has a conventional second detector and output circuit. The only additional necessary parts are an output transformer, PM speaker, three switches, and a three-conductor line.

The switch on the remote speaker serves to switch on the a.c. to the set. Considerable hum is heard due to running a.c. in the remote line, but this hum serves as an alarm to let us know that we are being called. Before beginning conversation, the set switch may be turned on and the remote one turned off, which will eliminate the hum.

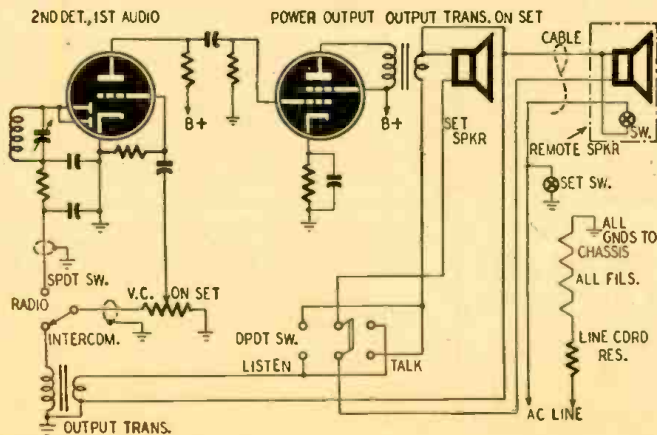

Left—Radio-intercom.  
Right—Phase inverter.

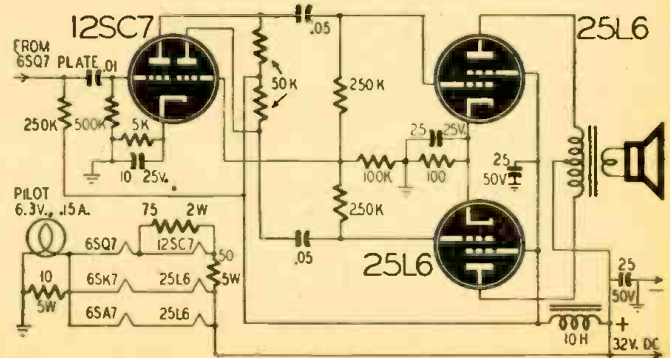

ELMER ARMSTRONG,  
Smeaton, Sask.

With the s.p.d.t switch, the unit may be used either as a radio or an intercom. To keep the volume full on in case we are called by the remote station, I used a separate set switch and volume control instead of a volume control switch attached.

BOB M. MANNING, W8LXA,  
Cleveland, Ohio

(The wire that carries the line voltage should be well insulated to prevent short circuits.—Editor)

RADIO-CRAFT welcomes new and original radio or electronic circuits. Hook-ups which show no advance or advantages over previously published circuits are not interesting to us. Send in your latest hook-ups—RADIO-CRAFT will extend a one-year subscription for each one accepted. Pencil diagrams—with short descriptions of the circuit—will be acceptable, but must be clearly drawn on a good-sized sheet.

## TESTER

Here is a simple output indicator, condenser tester and low voltage power supply that may be constructed very easily.

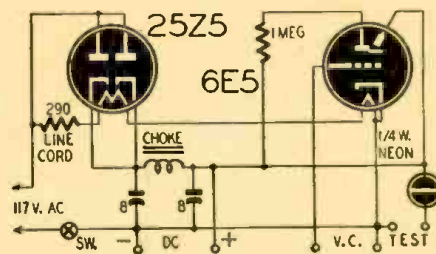

Condensers are tested by connecting them across the high-voltage leads in series with a small neon bulb. A shorted condenser will cause a steady glow. Good condensers will cause regular intermittent flashes. The frequency of the flashes is determined by the capacity of the condenser. An open condenser will not produce any flashes.

Terminals V and C are connected across the voice coil of a receiver under

test and indicate relative audio output.

If a tapped resistor is connected across the positive and negative terminals, the power supply may be used to substitute for B batteries.

NORMAN BROWN,  
Whittier, Calif.

## KIERSTAD REVISION

I built the reflex radio, described by Mr. Kierstad, on page 355 of the March, 1945 issue and had fairly good results

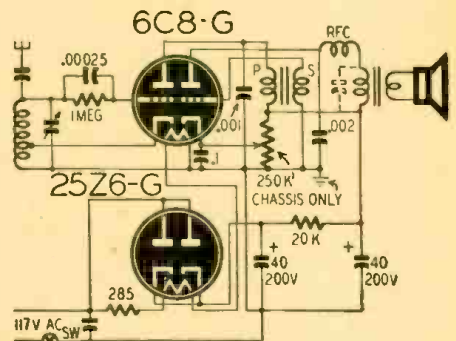

with the 6A8G detector. Later, I accidentally put a 6C8G in the socket in place of the 6A8G. I got the surprise of my life when the set played with about five times as much volume as when the original tube was used.

HUGO HEMILLA,  
Tarzwell, Ont.

## 32-VOLT RADIO

Recently I followed the method described by Mr. Embree, in the June 1945 issue, for converting a 2-volt battery set to operate from a 32-volt d.c. line. I tried the 25L6 transformer coupled to a pair of push-pull 25L6's. The volume was low and the tone quality was poor. Using the circuit shown, I replaced the driver and transformer with a 12SC7 phase inverter. The performance of the set showed marked improvement.

A 50-ohm resistor was placed in series with the filament of the 12SC7 to drop the voltage and a 75-ohm resistor connected across the filament to carry half of the filament current.

## IS TELEVISION REALLY HERE?

(Continued from page 853)

there is no real television audience in existence and there is not much likelihood that there will be one for a number of years to come. So much for a few of the complex problems that confront television today.

Again, this is not the whole story. There is for instance the high present cost of television receivers. To sell these by the tens of millions, the price must be low enough to appeal to the great general public in this country. Today the lowest price of video receivers is around \$200.00, and for this amount of money you do not get much.

For a really acceptable television that throws a fair size clear image, the price is in the neighborhood of \$500.\* Remember, television receivers are complex. To have both sight and sound you really must have two sets in one; one for video, the other for sound. This alone increases the price a great deal.

It seems improbable at the present state of the television art that the American public would soon be able to absorb 54 million television receivers—even at \$200 a set—a quantity necessary to support continuous daily, expensive and elaborate television programs to parallel the high quality broadcast programs current today.

In our estimation, the present *fundamental* television technique is not the final word in the art. *The popular price television will not arrive until our entire conception of television has been radically changed.* The means current today are not what television will be in years to come.

We have made this clear editorially for many years past. It is certain that the ultimate solution will not be the present day scanning cathode-ray tube.

We quote from our editorial in the February, 1934, issue of RADIO-CRAFT:

"This scanning idea, to my mind, is all wrong and totally unnecessary. When the final television invention comes along, one which may be likened to the radio tube of today as compared with the radio crystal of yore, it will be found that the scanning idea is conspicuous by its absence.

"Some thirty million years ago, nature invented the first real television machine which, so far, has not been duplicated by man. I refer, of course, to the animal eye, which has been in existence on this planet for millions of years, and is open for study by all television aspirants.

"The animal eye (which, of course, includes the human eye) is almost a perfect television receiver and transmitter. Not only does it receive an image from the outside world by means of light rays and then transmit it through the optic nerve to the brain, but it goes the television engineer several steps better; because in the first place, the eye gets along marvelously well WITHOUT ANY SCANNING MECHANISM, but the image is received and transmitted in colors as well."

What was said above in 1934 still holds true now, if the television industry is to succeed as has the broadcast industry.

Basically, television as we know it today is technically unsound. Shortly after the year 1800 there was an "automobile" running in the streets in London. It made about two or three miles an hour and was built by James Watt of steam-engine fame. It was as big as a good-sized room, but nevertheless it was an "automobile." It was totally impractical and nothing came of it until Gottlieb Daimler perfected the gasoline internal combustion engine. Then, in 1887, his automobile became the first practical self-propelled road vehicle.

We have always been strong in our

## Build Your Own

The Finest  
In Radio Kits

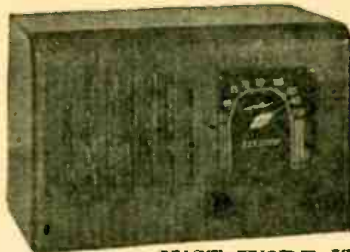

JUST WIRE IT

All Parts Are Mounted  
**ATOMIC HEATER & RADIO CORPORATION**

DEPT R.C.

104 PARK ROW

NEW YORK 7, N. Y.

The design, engineering and materials simplify construction and insure excellent reception and tone.

Cabinet is beautiful example of craftsmanship, made of choice veneer.

Tubes Required: Two 12SK7, One 12SA7, One 12SQ7, One 35L6, One 35Z5.

YOUR COST WITHOUT TUBES, \$15.80

Terms—10% Deposit with Order, Balance C.O.D.

Immediate Delivery

## Electricity

Capacity range: 350 to 35,000 watts; 115 to 660 volts A.C.; 50 to 800 cycles; 6 to 800 volts D.C.; combination A.C.—D.C. types.

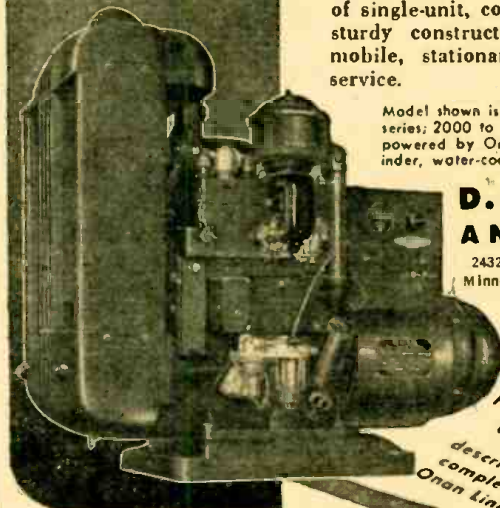

FOR RADIO AND ELECTRONIC APPLICATIONS

ONAN ELECTRIC GENERATING PLANTS supply reliable, economical electrical service for electronics and television applications as well as for scores of general uses. Driven by Onan-built, 4-cycle gasoline engines, these power units are of single-unit, compact design and sturdy construction. Suitable for mobile, stationary or emergency service.

Model shown is from W35 series; 2000 to 3500 watts; powered by Onan two-cylinder, water-cooled engine.

**D. W. ONAN AND SONS**

2432 Royalston Avenue  
Minneapolis 5, Minn.

Write For Folder 630 describing complete Onan Line

belief in television, and are certain that it is here to stay. However, it will slowly evolve as did radio. Nor do we believe that there is a short cut to country-wide, popular television on the horizon.

We wish to emphasize the point that what has been said here pertains *only* to broadcast television and programs *received in the home.* It does not refer to television in the theatre; television in department stores; and television for other commercial purposes, where the high cost of a receiver does not matter. Such specialized receivers are not bought by the millions and therefore are in a class by themselves.

\*Dumont, one of the foremost television manufacturers, is selling teleceivers for \$1600 and \$2400, immediate delivery, and "taking orders" for their "cheap" \$600 set, according to recent New York City newspaper advertisements.

## HOW TO MAKE MONEY BY MAIL

The easy way to start new, or expand your present occupation. Extraordinary plan, simple skill, know-how, act story of rich experience of author E. Rice day-by-day, no theory. YOU DID NOT NEED MONEY TO START THIS RICE WAY. His method automatically pays all bills at once, no loans, pay as you go, no worry, quickly a home of your own all paid for. Rice paid off on a \$5,000 mortgage one year after using this skillful idea. Read how buyers of this book are making Rice's plan go big. . . . Does this sound fishy? Well, Rice has been doing it continuously for 46 years. He made this plan work when living in one room in a Boston lodging-house. Make this effective idea go with anything you are selling or doing. Turn your city or country home, your work, your hobby, into money, follow for YOUR success the easy business pattern disclosed in this book. Cloth-bound, 5 1/2 by 8 1/4 inches 14th edition, best seller, enlarged to 576 pages, 165 business adventures, no cut-and-dried teachy talk. Hundreds of buyers whose letters we show you declare emphatically its superlative goodness. PRICE \$2.95 postage paid, mailed same day check or money-order is received. Address: HOWARD HOUSE, Melrose 76-26, Massachusetts



# SUPER BARGAINS

## IN RADIO • ELECTRONIC AND COMMUNICATION SUPPLIES

Order Today —  
Immediate Delivery

### PLATE TRANSFORMER

6200 Volt CT — 700  
Mils, 110 Volts, 60  
Cycles tapped primary  
2KVA Amertram.  
Limited quantity  
.....\$39.95



### CONDENSERS

Variable Condenser, split stator ceramic  
insulation 120MMF per section .003  
spacing .....\$ 1.69  
Variable Condenser—E.F. Johnson split  
stator 150MMF per section .175 spac-  
ing—7000 Volts. Your cost ..... 8.95  
.003 mica bypass conds. 2500 Volts  
working—Sangamo Type H ..... .45  
Sprague .1 mfd 7500 V.D.C. condenser 2.89  
4 MFD 3000 Volt G.E. Pyranol ..... 5.95

### TRANSFORMERS

Driver Transformer — single 6V6 to  
push-pull 811 grids. Chicago Trans-  
former Co. .... 1.50  
Plate Transformer built by Kenyon. 1450  
Volts C.T. @ 420 mils, 110 Volt, 60  
Cycles primary ..... 7.95  
A hot transformer — look at this. 10  
Volts 10 amps—6 Volts 4 amps—650  
Volt C.T., 125 mils, 110 Volt 60  
Cycles primary ..... 2.98  
Thordarson Transformer 389 V. each  
side of center @ 200 mils, 5V, 3  
amps 6.3 V, 5 amps and matching  
choke 15 henries @ 150 mils, special 7.25  
866 Filament Transformer 2½ V. at  
10 A. Kenyon—insulated for 10,000  
Volts—Pri 110 Volts, 60 Cycles..... 4.25

### MISCELLANEOUS

In stock Westline Xtals—let us know  
your freqs. .... 2.80  
¼" flexible coupling low loss bakelite  
disc ..... .15  
Tube socket for 100 TS tubes made of  
mycalex ..... 1.98  
Swinging choke—Langevin 9/60 henries  
400/50 mils. DC Resistance 72 ohms. 12.75  
"S" meter—0 to 1 mil movement 2½"  
bakelite case—reads up to 10 ..... 3.95  
Motor type time delay relay—adjustable  
to 1 minute, 110 Volt 60 Cy. Hayden 5.95  
Still a few left Hewlett Packard 200 B  
audio oscillators ..... 74.95  
Cool that Kilowatt—Dual Blower blows  
200 cubic ft. per minute. Delco 110  
Volt, 60 Cy. Completely noise free 15.95  
All prices FOB our  
warehouse New York  
City, N. Y. Write for  
our latest bulletin 4RC.



**NIAGARA RADIO SUPPLY**  
160 Greenwich St., New York 6, N. Y.  
Bowling Green 9-7993

# TRY THIS ONE

## INVERTER FOR SHAVER

Here is a simple inverter that may be used with a 6-volt storage battery to run a 110-volt motor-driven electric shaver.

High voltage is supplied by a 10-volt, 4-ampere filament transformer with its windings connected in reverse. The secondary is connected across the fixed contacts of a vibrator. The primary is used to supply 117-volt a.c. to the shaver. The capacity of the buffer condenser, C, will differ from the value shown when other vibrators are used. Various values of capacity are tried

RADIO-CRAFT wants original kinks from its readers, and will award a one year subscription for each one published. To be accepted, ideas must be new and useful. Send your pet short-cut or new idea in today!

for minimum sparking at the vibrator points. A synchronous vibrator with contacts wired in parallel will operate more efficiently and with less sparking than the non-synchronous type of vibrator.

The voltage output is 125 with no load and 118 volts with full load of 9 watts. The input draws 2 amperes no-load and 2.5 amperes under load (approximately 10 watts for the average shaver).

It is doubtful if this converter will

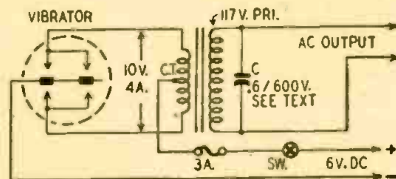

work with a vibrator-type shaver as the output frequency is in the vicinity of 115 c.p.s.

JAMES A. EASTHAM,  
Indianapolis, Ind.

## EMERGENCY IRON

Soldering by the carbon arc method has been described previously and needs no further explanation. In tight and inaccessible places I find the following method useful.

Connect two leads, with alligator clips on each end, to 5 volts a.c. Insert a small hard carbon motor brush in one clip. Connect the other clip to the solder several inches from the end. Touch the brush and solder to the joint to be soldered. For best results, the brush and solder should not make direct contact with each other.

ALBERT SPARKS,  
Oklahoma City, Okla.

## LOUDSPEAKER

While thumbing through the October issue of RADIO-CRAFT I saw Mr. Youngman's description of a door buzzer made from an old loudspeaker. The editor's note—suggesting that a radioman would prefer to reverse the process—reminded me of a small speaker that I once constructed from an old door buzzer.

I removed the core from the coils and replaced it with short lengths of spring

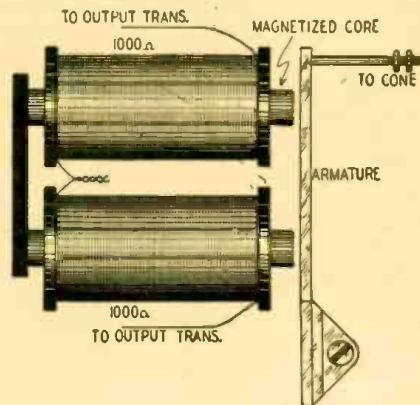

steel wire. This wire was then magnetized. The coils were rewound with fine wire to a resistance of about 2000 ohms. A small rod was soldered to the armature and fastened to an old speaker cone. Obviously, the armature adjusting screw was not needed so was removed.

RONALD G. BERLYN,  
Ballarat, Australia

## DIAL CORDS

Dial cords are often hard to replace on receivers that use a number of pulleys placed in almost inaccessible positions. The method described here may be used, in many of these cases, for a quick and accurate replacement on problem receivers.

Attach two pieces of cord to the proper places on the dial drum. Thread the free ends around the pulleys and bring them out to a point where they may be tied with a square knot. Saturate the knot with coil dope or Duco cement and clip the ends.

OTTO WOOLLEY,  
Colo. Springs, Colo.

(Note: The knot should be small enough to run freely in the pulleys so that it will not jam or throw the cord off the track.—Editor)

## COOL RESISTORS

Hollow high-wattage resistors run much cooler when mounted on a long brass screw fastened to the chassis.

PETER S. WALTNER,  
Inglewood, Calif.



## WORLD-WIDE STATION LIST

(Continued from page 842)

Location	Station	Frequency and Schedule
London	GWG 15.110	West African beam, 1 to 4 pm; Far East beam, 1 to 8:30 am; South-western Pacific beam, 1 to 5 am; Northwestern Pacific beam, 1 to 10:15 am
London	GSF 15.140	West African beam, 2:30 to 4:15 pm; Indian beam, 12:30 to 4 am; 5 to 10:15 am
London	GSO 15.180	Italian beam, 4 to 10 am; Central American beam, 4 to 5:45 pm; Near East beam, 12:30 to 5 am; 6 to 10 am; 10:30 am to 2:30 pm
London	GSI 15.260	South African beam, 10:30 am to 2 pm
London	GWR 15.300	Near East beam, 5 to 6 am; South American beam, 3 to 5:45 pm; Middle East beam, 12:30 to 1:45 am
London	GSP 15.310	North American beam, 4:15 pm to 7:45 pm; 6 to 8:15 am; Australian beam, 1 to 5 am; New Zealand beam, 1 to 5 am
London	GRE 15.375	
London	GRD 15.450	African beam, 10:30 am to 2:30 pm
London	GVP 17.700	Middle East beam, 1 to 5 am; 6 to 10 am; 10:30 am to 12:15 pm
London	GRA 17.715	New Zealand and Australian beam, 2:30 to 5 am
London	GVQ 17.730	Near East beam, 6 am to noon; Central American beam, noon to 4 pm; 6 to 8:30 am; Far East beam, 2 to 6 am; Indian beam, 2 to 5 am; Southwest Pacific beam, 2 to 5 am
London	GSG 17.790	New Zealand beam, 2:30 to 5 am
London	GSV 17.810	South African beam, 1 to 4 am; Indian beam, 5 to 10:15 pm; West African beam, 2 to 4 am
London	GPP 17.870	Northwest Pacific beam, 1 to 5 am; 6 to 8:15 am; South African beam, 10:30 am to 12:45 pm
London	GRQ 18.025	South African beam, 5 to 9 am; 10 am to 12:15 pm; West African beam, 5 to 9 am; 10 am to 2:30 pm
London	GVO 18.080	North American beam, 8 am to 6:45 pm; South American beam, noon to 4:15 pm
London	GSH 21.470	South African beam, 5 to 10:15 am; Near East beam, 5 to 10:15 am; West African beam, 5 to 10:15 am
London	GSJ 21.530	Indian beam, 5 to 8:15 am
London	GST 21.550	
London	GRZ 21.640	Central American beam, 8:30 to 10:15 am
London	GVS 21.710	South American beam, 6 to 10:15 am
London	GVT 21.750	
London	GSQ 23.750	
London	GSK 26.100	South African beam, 6:15 to 10:15 am; West African beam, 6:15 to 10:15 am
London	GSR 26.400	
London	GSS 26.550	
ETHIOPIA	Addis Ababa	4.965 10:30 to 11:30 am
FJI ISLANDS	Suva	VPD2 6.130 Sundays, 1 to 5 am; other days, 3 to 4 pm
FINLAND	Lahiti	OIX5 17.800 8 am to 12:30 pm
FRANCE	Paris	9.520 North American beam, 12:30 to 12:45 am; 1 to 1:15 am

(Continued on page 862)

## 500 FORMULAS TO SUCCESS

MANY million dollar firms started with a single formula, for which they paid a big price. Here you have 500—no less—tried and tested formulas, recipes and processes for making things . . . all at the ridiculously low price of 25c.

Here is your opportunity to start a business with but a few dollars' capital and with undreamed of profits in prospect. You can also use these formulas in your own home to cut household expenses to the bone. Or you can put them to use in your workshop to cut costs as much as 100%.

Quit paying out many dollars in profits to manufacturers, wholesalers and dealers, when you can make the same thing yourself for a few cents. It's so easy when you follow our simple instructions.

66 PAGES, 3200 WORDS IN TEXT. Send for "500 FORMULAS AND RECIPES" today. Enclose 25c, that's all! You won't be asked for another cent now or later. Sold on a money-back guarantee.

**NATIONAL PLANS COMPANY**  
P. O. BOX 26, 5 STATION N., New York 23, N. Y.



for everything in Radio

# Get ALLIED'S 1946 RADIO CATALOG

**FREE** send for it now!



## LARGEST STOCKS OF RADIO AND ELECTRONICS EQUIPMENT

Get the handiest, most complete Buying Guide in Radio! Packed with the latest, finest values in parts, tubes, test instruments, tools, books, communication receivers, Ham gear, public address equipment . . . more than 10,000 items of nationally known, guaranteed quality . . . the world's largest and most complete stocks. For earliest delivery, fastest service, lowest prices, depend on ALLIED! Send for this FREE 1946 Catalog now.

**MORE THAN 10,000 ITEMS**—Largest and most complete selection of radio and electronic equipment to serve the needs of engineers, servicemen, dealers, soundmen, amateurs, and builders. All the leading makes. Guaranteed quality. Lowest prices. Everything you need from one dependable supply source!

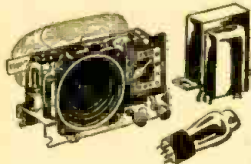

### HAM GEAR

Earliest delivery on latest communication receivers and transmitters. Time payment plan; trade-ins accepted.

### HOME SETS

Parade of 1946 radios and phonoradios. Handsome styles. Wonderful performance. Today's leading values.



**NEW P. A. EQUIPMENT**—Complete Sound Systems for every public address requirement. All the newest developments. Everything in amplifiers, speakers, microphones, accessories. New intercom systems. Also the latest developments in recording and record-playing mechanisms.

### HANDY RADIO BOOKS

Radio Formulas and Data Dictionary of Radio Terms  
Radio Circuit Handbook  
Radio Builders' Handbook  
Simplified Radio Servicing  
Radio Data Handbook

ALL SIX BOOKS No. 37-799 . . . 75c

### HELPFUL CALCULATORS

These radio reference aids provide valuable data quickly:  
Parallel Resistance and Series Capacitance Calculator, No. 37-960. 25c  
R-F Resonance and Coil Winding Calculator, No. 37-955. . . 25c



ALLIED RADIO CORP.  
833 W. Jackson Blvd., Dept. 12-JJ-6  
Chicago 7, Illinois

**FREE**

- Send FREE 1946 RADIO CATALOG
- Send Six Books No. 37-799
- Send Calculator No. 37-960 } \$.....enclosed
- Send Calculator No. 37-955 }

Name.....

Address.....

City..... Zone..... State.....

# ALLIED RADIO

Everything in Radio and Electronics

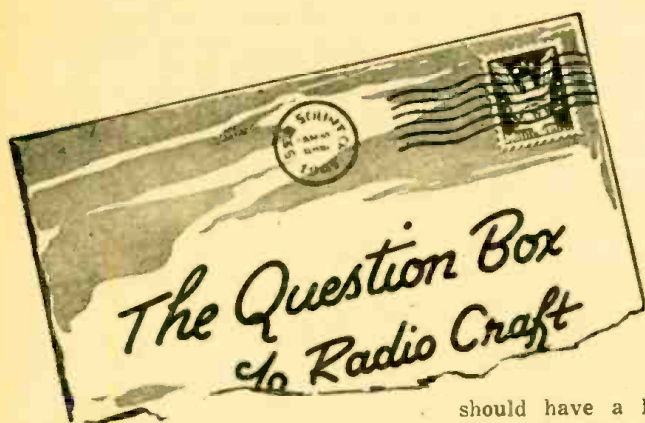

The Question Box is again undertaking to answer a limited number of questions. Queries will be answered by mail and those of general interest will be printed in the magazine. A fee of 50c will be charged for simple questions requiring no schematics. Write for estimate on such questions as may require diagrams or considerable research.

### METER RECTIFIER

I have purchased a copper-oxide rectifier to use with my d.c. meter but have received no instructions for connecting it into the meter circuit. This rectifier has five terminals and is designed to pass 20 ma at 4 volts a.c. Please print a diagram showing how this device is connected to the meter.—C.C.M., Cleveland, Ohio.

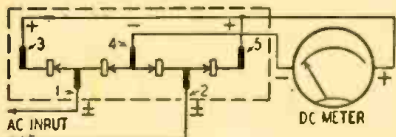

A. A meter-rectifier circuit is shown in the accompanying diagram. The a.c. terminals are usually the ones on either side of the center terminal. In many rectifiers, the end terminals will be connected internally and there will only be four terminals on the unit. The a.c. terminals may be identified with an ohmmeter. The resistance between these terminals will be very high regardless of the polarity of test leads.

### P. A. AMPLIFIER

Please print a diagram of a medium power public address amplifier using a pair of push-pull 45's in the output stage. I have two 27's and a 53 that I would like to use in other stages. My

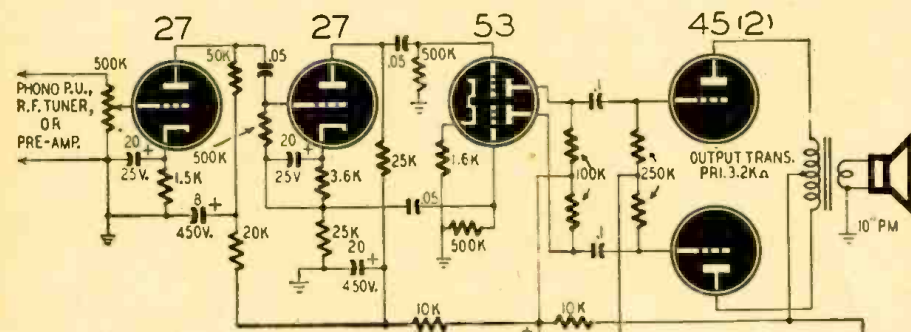

speaker has a 2500-ohm field. Will it be possible to use this with the amplifier?—T.M., Lonaconing, Md.

A. Here is a diagram that will meet your specifications. A 27 speech amplifier feeds a 27 phase inverter working into a 53 connected as a push-pull driver. The grid bias should be adjusted by varying the position of the slider on the resistor across the speaker field, which

should have a lower resistance than yours, for best results.

This amplifier will work well with a phonograph pickup or r.f. tuner but it is recommended that a preamplifier be used when working from a crystal or dynamic microphone.

### WIRELESS TUNER

I would like to have a diagram of a wireless push-button tuner to use with my broadcast receiver. I would like to operate this device from an a.c.-d.c. power supply so that it can be built as compactly as possible.—E.S.C., Collingdale, Penna.

A. The diagram shown should meet your requirements. It is equipped with six push-buttons which will allow you to tune in any one of six pre-selected stations.

T1 and T2 are standard i.f. transformers which may be tuned to frequencies between 550 and 600 kc. It may

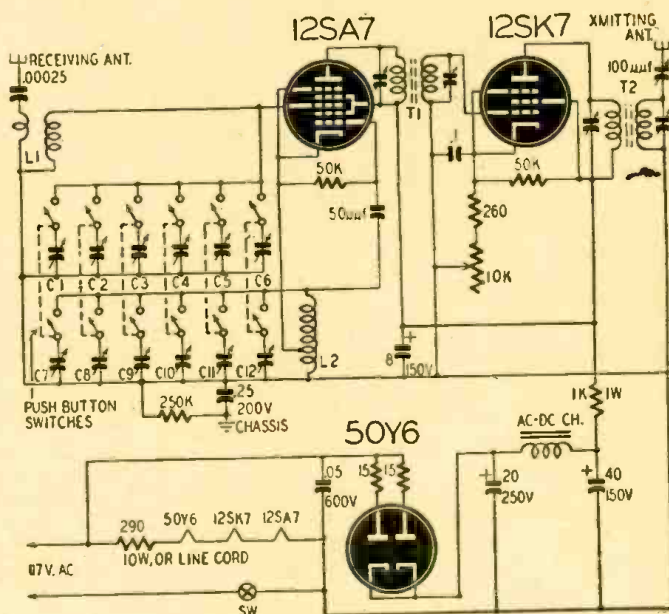

### 32-VOLT D.C. TRANSFORMER

Please publish winding data for a power transformer to supply 90 volts from a 32-volt d.c. storage battery. I plan to use a 32-volt synchronous vibrator.—E.R., Mandan, N. D.

A. You may wind your own transformer on a 1-inch square core as follows: Primary, 300 turns, center-tapped, No. 28 enamel wire. The secondary is wound with 1020 turns, center-tapped, No. 32 to No. 34 enamel wire. This design will give 40 to 50 milliamperes at the rated voltage. If the voltage is too high a resistor may be placed in the B-plus lead or a choke-input filter used.

Note well that the "window" must be large enough to hold the windings, something often overlooked by a beginner.

A reference article, "Practical Transformer Design," appeared in the Sept.-Oct. 1942 issue of RADIO-CRAFT. It described how to calculate core sizes for given wattages, estimating the window space needed, and how actually to put the windings on the form.

**Radio Thirty-Five Years Ago**  
In Gernsback Publications

**HUGO GERNSBACK**  
Founder

Modern Electrics	1908
Electrical Experimenter	1913
Radio News	1919
Science & Invention	1920
Radio-Craft	1929
Short-Wave Craft	1930
Wireless Association of America	1908

Some of the larger libraries in the country still have copies of MODERN ELECTRICS on file for interested readers.

From the September, 1911, issue of MODERN ELECTRICS.

Wireless On the Motor Boat, by *Richard H. Foster.*

High Powered Condensers, by *Frank C. Perkins.*

Improvement on Loose-Coupled Tuning Coils, by *P. Mertz.*

Helix Insulation, Water Resistor, and Battery Economizing, by *E. Jay Quinby.*

Another System of Wireless Telegraphy and Telephony, by *John B. Brady.*

A Sending Condenser, by *H. V. Roome.*

The Legality of "Wireless Tapping," by *Stanley McClatchie.*

Ducretet Rotary Spark Gap. Long Range Potentiometer. Transmitting Pictures Wirelessly. A Novel (variable) Condenser. High Pitch Spark Producer, by *Robert E. Smith.*

Increasing Sensitiveness of (head-phone) Receivers, by *Earl Clifford.*

**AMATEURS!!**

**Leo W9GFQ Offers Immediate Delivery**

ON HIS NEW, EXCLUSIVE, LOW PRICED

**WRL GLOBE TROTTER TRANSMITTER KIT**



AMATEURS ACCLAIM ITS SUPERIOR Performance **\$59.95**

The Hottest amateur rig on the market today. Place your orders now.

Completely Wired, \$75 (Accessories \$13.85 extra)



**New Type PHONO OSCILLATOR**  
Wired, less tubes. Cat. No. 16-191 **\$4.95**

No aerial required. Utilizes high quality loop both as part of oscillator circuit, and radiating medium. Trimmer provided to adjust frequency to any portion of broadcast band between 1250 KC and 1700 KC. Uses 35L6 and 3Z5 tubes

**FREE! Our Latest Flyer**

Radio Reference Map (3 1/2' x 4 1/2') ... 15c  
Tube-Base Calculator ... 25c  
Tube and Circuit Book ... 10c



Formerly Wholesale Radio Lab. Address Dept. RC-9, Council Bluffs, Iowa.

**PRICES GO DOWN**  
AS MORE ELECTRONIC PARTS ARE AVAILABLE

**COMPLETE TRANSMITTING & RECEIVING SETS** as used by government—no components removed.

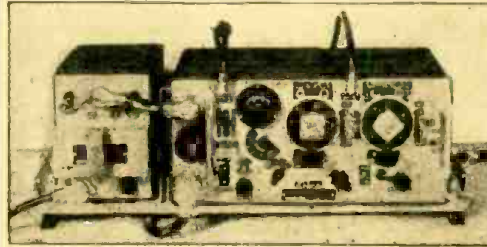

operation or remote control operation in an extremely flexible arrangement in 3 different locations.  
**POWER SUPPLY:** This unit, including dynamotor, operates from a 12-volt storage battery. These sets are ideal for mobile or marine installations. 2 Antennas, 1 Veriometer Resonator, Spare Set Tubes, Generator, Set of Spare Parts; 5 sets Earphones, 5 sets Microphones.

**BRAND NEW!**

**3 SETS IN ONE — 15 TUBES**  
MADE BY ZENITH & EMERSON

SET A, for telephone and telegraph includes: 6 tube superheterodyne receiver and 6-tube MOPA transmitter with 807 final amplifier. Grid modulated for telephone. Specialized circuits make this set ideal for network operations. The frequency range of 2 to 8 megacycles includes the 80 meter and 40 meter amateur bands.

SET B, consists of 235 megacycle transceiver that can be shifted to the 144 or 225 megacycle amateur bands. SET C, a complete inter-communication system using 3 control boxes and 3 combination headphones—push-to-talk microphone, providing inter-communication in 3 different locations.

**\$68.50**

**NEW RECEIVERS B.C.**

603 semi-completed, made for 603 Tank F.M. **\$4.50**  
less var. cond. and front panel. no tubes.  
Cabinet ..... .25  
Tech. Book ..... .50

3 CM Klystron converter, with two 6AC7's. Less Klystron ..... \$10.00  
723 A/B Klystron, for converter, new ..... 10.00  
Large selection of 3CM Plumbing. Send for our listings of Waveguide, Wavemeters, Attenuators, etc.  
Complete stock of 400-2400 cycle Transformers. Send us your requirements.

Freq. Meter B.C. 221 with calibrated chart and tubes, 1,000 KC. crystal and micro V dial, 120 KC. to 20 meg. Perfect. **\$82.50**

**U. S. NAVY MODEL RAK-7 SHIP RECEIVER NEW—IN CASES**

15 Kc. to 600 Kc. 6-tube receiver with AVC—Band pass filter—Audio filter—Noise limiter—precision tuning—Voltage regulated power supply for 60 cycle 115 V.—Can be battery operated. Complete with spare parts, tubes (in metal box) and instruction book.

**\$73.50**

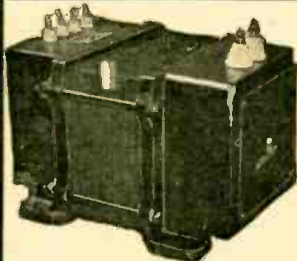

**AMERTRAN PLATE TRANSFORMER**

115v-60c/6200v-ct 700 ma. Tapped at 2850v. Special Price **\$39.95**

**RADAR. RADIO COMPONENTS**

UHF Receiver, BC-406. From SCR-268. Freq. Range: 201-210 mc. 15 tube superhet. 20 mc. I.F. 2 mc. band width. 115v-60c oper. .... \$21.95  
Oscilloscope 5", BC-412. from SCR-268. uses 115v. a.c. Complete with conversion dia. and instr. .... 54.50  
Modulation XFMR: 807 to pair of 807's ..... 2.65  
Modulation XFMR: 811's to 813 ..... 5.00  
Driver: 8V6 to pair 811's ..... 3.00  
C.H. Transf. P.P. Mod. & Driver. 6L6's—oor pair ..... 3.30  
IWR: 115v 60c/330-0-330, 85 ma/6.3v. 7.5a/5v-2a/6.3v-3a ..... 3.95  
IWR: 115v 60c/750v-110 ma/ct./6.3v-5a/6v-3a ..... 5.95  
I.V. Plate: 115v 60c/3200v-150 ma ..... 9.95  
Swinging Choke: 2.5 hy @ 375 ma; 10 hy @ 75 ma ..... 3.95  
GE Pyranol 25F47 2 mfd 4000 VDC (List \$30) ..... 6.95  
SANGAMOQ-4 Mica .004 mfd 20,000v ..... 25.50  
Mica, Sangamo F3L 0005-8000VDC (List \$29) ..... 5.25  
Johnson 500D35 Variable, 501 mmfd. 3500v (List \$11.75) 4.75

**TUBES**

304 TL, perfect ..... 11.00  
5BP1, Sylvania ..... 8.75  
5BP7, Phillips ..... 11.00  
5BT4 ..... 6.95  
6J1 ..... 9.95

**CECO KITS**

KIT 1: 1000 pieces hardware, asstd. \$2.49  
KIT 2: 100-ft. spaghetti, all sizes ..... 1.30  
KIT 3: 50 mica condensers, asstd. 4.65  
KIT 4: 200 resistors, asstd. 5.95

**IF CRYSTAL FILTER**  
For BC-312; BC-342 Resonant at 470 Kcs. Xtal incl. **\$9.95**

**SEND FOR FLYER**

All merchandise guaranteed. Mail orders promptly filled. All prices F.O.B. New York City. Send Money Order or Check. Shipping charges sent C. O. D. Send for Flyers.

**COMMUNICATIONS EQUIPMENT CO.**

131-C LIBERTY ST., NEW YORK CITY 7, N. Y.

TELEPHONE WH 4-7658

# NEW RADIO-ELECTRONIC PATENTS

Edited by I. QUEEN

## UHF MEASUREMENT

Ralph W. George, Riverhead, N. Y.  
Patent No. 2,399,481

THE measurement of u.h.f. voltage is a very difficult process. At the microwave frequencies, an accurate measurement is not generally possible with conventional apparatus. The invention described here requires only a special wire element and an ordinary bridge circuit and power supply. It is effective up to several thousand megacycles.

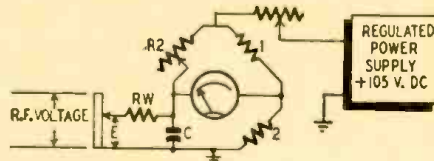

One arm of the bridge is a platinum or wollaston wire only  $\frac{1}{8}$ " long and .1 mil in diameter, having an approximate resistance of 73 ohms at room temperature. The arms 1 and 2 are fixed resistors and R2 is adjustable. The condenser C serves to by-pass the r.f. currents so that they do not enter other parts of the bridge. A regulated power supply is desirable to energize the bridge.

To operate the circuit, the bridge is first balanced with no r.f. through RW. When the current is turned on, it heats the small platinum wire and therefore causes its resistance to increase, unbalancing the bridge. In order to determine the exact value of voltage, a known source of d.c. is substituted for the r.f. and its potential is adjusted until the same deflection is obtained on the microammeter. The two voltages are then equal.

## HIGH FIDELITY AMPLIFIER

James B. Crawley, Camden, N. J.  
Patent No. 2,400,919

THIS is an unusual 2-tube amplifier which shows excellent fidelity to almost 15,000 cycles per second.

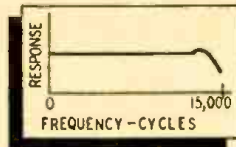

The first tube is direct coupled to the screen-grid of the second in addition to capacitance coupling to the control-grid. Degenerative feedback is accomplished through the same condenser by coupling the plate and suppressor of the first tube. Further negative feedback results because the screen of the second tube is not by-passed to ground. Note that these effects are secured without using additional components beyond those generally required for other amplifiers.

A typical response curve is shown above.

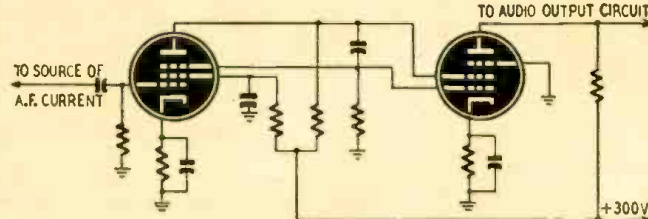

## STANDING WAVE INDICATION

Donald W. Peterson, Princeton, N. J.  
Patent No. 2,400,597

THE most important measurement which concerns antenna design is that of standing wave ratios. An impedance mismatch results in the existence of standing waves along the transmission line. Therefore, it is necessary to reduce them for maximum power output. One possible method consists of using a v.t.v.m. arranged to slide along the line while the ratio of maximum-to-minimum-voltage is noted. This is a very in-

convenient method, especially with coaxial line.

To simplify the process, a portion of the coaxial line is arranged in circular form. A movable arm containing a probe contacts the internal conductor and feeds the voltage to a detector, whose output is indicated as a vertical deflection on an oscilloscope. The variable arm is operated by a motor which also controls a switching cam as shown.

During each revolution of the arm, the cam switch is closed once. This provides the horizon-

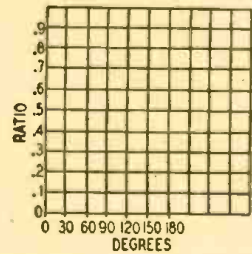

tal synchronizing pulse which starts the horizontal deflection. As a result, the pattern shows the relative voltage at each point of the circular coaxial line. A celluloid screen marked off in angles as shown makes it convenient to inter-

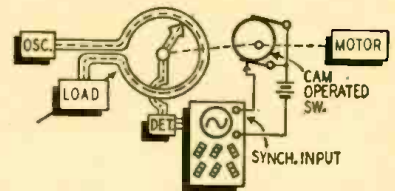

pret the standing waves. Gain and deflection controls are adjusted until a full wave covers 180 degrees. The pattern may be observed while necessary adjustments are made.

## HIGH FIDELITY DISC RECORDING

Henry E. Roys, Indianapolis, Ind.  
Patent No. 2,400,953

NEGATIVE feedback is widely used in electrical and mechanical systems for the re-

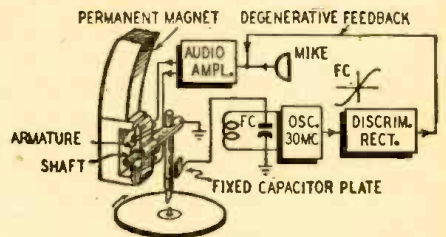

duction of distortion. Greatly increased fidelity can be obtained from a disc recording system by the use of negative feedback. For best results it should include not only the amplifier but the vibrating stylus as well.

One possible connection uses a coil in which the stylus induces a voltage to be fed back to the amplifier in proper phase. This has a tendency to cause undesired coupling with the recording coil besides adding mass to the vibrating system, another undesirable feature.

An effective solution is the use of FM to derive the negative feedback voltage. A small capacitor plate is used in conjunction (but not in contact) with the stylus. Vibration of the latter modulates the frequency of a high-frequency oscillator (for example 30 mc.). The modulated output is applied to a discriminator and this audio voltage can be used as negative feedback.



● Heretofore offered only in cardboard-case container, this type is now available in an aluminum can—the postwar Aerovox Type PRVC.

This truly universal replacement electrolytic readily doubles for twist-prong, spade-lug and screw-base types. To install, center screw is removed, metal cleat slipped off, wire leads passed through mounting hole, and metal cleat and screw now replaced from underside of chassis and tightly drawn up. Insulated positive and negative wire leads. Multiple sections have concentrically-wound sections with common negative. In all popular voltages and capacitances.

### ● Ask Our Jobber . . .

Order your Aerovox Type PRVC metal-can cleat-mounting electrolytics from him. Have a stock on hand for those rush jobs. Ask for postwar catalog — or write us.



FOR RADIO-ELECTRONIC AND INDUSTRIAL APPLICATIONS

AEROVOX CORP., NEW BEDFORD, MASS., U.S.A.  
Export: 13 E. 40th St., New York 16, N.Y. • Cable: 'ARLAB'  
In Canada: AEROVOX CANADA LTD., Hamilton, Ont.

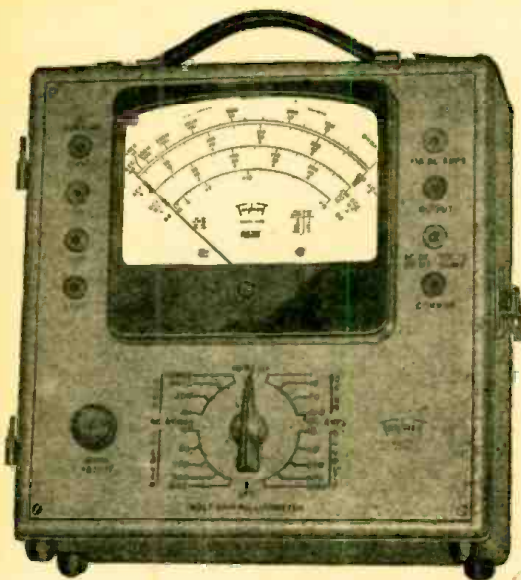

MODEL 2405

# Volt·Ohm·Milliammeter

25,000 OHMS PER VOLT D.C.



## SPECIFICATIONS

NEW "SQUARE LINE" metal case, attractive tan "hammered" baked-on enamel, brown trim.

■ **PLUG-IN RECTIFIER**—replacement in case of overloading is as simple as changing radio tube.

■ **READABILITY**—the most readable of all Volt-Ohm-Milliammeter scales—5.6 inches long at top arc.

■ **RED·DOT LIFETIME GUARANTEE** on 6" instrument protects against defects in workmanship and material.

### NEW ENGINEERING • NEW DESIGN • NEW RANGES 30 RANGES

Voltage: 5 D.C. 0-10-50-250-500-1000 at 25000 ohms per volt.

5 A.C. 0-10-50-250-500-1000 at 1000 ohms per volt.

Current: 4 A.C. 0-.5-1-5-10 amp.  
6 D.C. 0-50 microamperes — 0-1-10-50-250 milliamperes—0-10 amperes.

4 Resistance 0-4000-40,000 ohms—4-40 megohms.

6 Decibel -10 to +15, +29, +43, +49, +55  
Output Condenser in series with A.C. volt ranges.

Model 2400 is similar but has D.C. volts Ranges at 5000 ohms per volt.

Write for complete description

# Triplet

ELECTRICAL INSTRUMENT CO.

BLUFFTON, OHIO.

### RADIO TEST EQUIPMENT

(Continued from page 838)

point at the right end of the scale calibration.

#### DECIBEL READINGS

Most volt-ohm-milliammeters have decibel scales printed on them. Decibel meters are a.c. voltmeters having calibrations that are converted from a.c. voltage readings developed across a specified impedance line and having a stated reference level to decibel equivalents. These readings are usually based on the reference level: Zero Decibels = .006 watts (6 milliwatts) into a 500-ohm impedance line. If the line impedance is other than 500 ohms or if the reference level should be other than 6 milliwatts, these readings are valueless.

Fig. 8 is a chart for adapting any a.c. meter having a 15-volt, 150-volt, or 1500-volt a.c. range to a decibel meter: For 15-volt range read db directly. For 150-volt range add + 20 db to db scale. For 1500-volt range add + 40 db to db scale.

The author has endeavored to describe the workings of volt-ohm-milliammeters so that anyone with a knowledge of electrical theory and terms may understand them. The workings of more complex test equipment such as signal generators, signal tracers and vacuum tube voltmeters, have been amply presented in previous articles in this magazine, and in books published on these subjects.

## HAM HEADQUARTERS FOR Equipment and Information

### SPECIALS

- Aladdin—5.3 MC IF Transformer input-output Diode ..... 1.15
- Colonial Radio Corp. TBY Whip Antenna ..... 1.95
- BC-312 6 Band RF coils with switch Pyrexglass insulator with four MTG screws ..... .39
- 3 Mfd. — 2000 Volt G.E. .... 3.50
- 3 x 3 Mfd. 600 Volt Oil Filled ..... .99
- Tubes—3C24/24G ..... 1.90
- Aero Running Time Meter 60 Cycle AC.... 3.50

Mail Orders Promptly Filled  
Amateurs to Serve You

(20% Must Accompany All C.O.D. Orders)

Write Dept. RC  
W6SCQ—W6UXN—W6NAT  
W6SSU

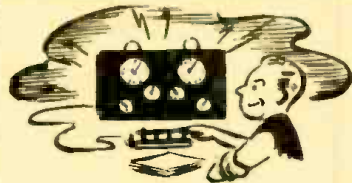

## FOR YOUR NEW RIG

We Have a Good Stock of  
All Standard Lines

### SUPER DELUXE SPECIAL

5 Tube 24 Watt Code  
Practise Osc. \$29.50

A few minor changes the amplifier can be converted to speech or P.A. Audio Amplifier, complete with tubes and dust cover.

## Radio Product Sales Company

238 WEST 15TH STREET  
LOS ANGELES 15, CALIFORNIA PProspect 7471

# OHMITE

## Little Devil

INSULATED  
COMPOSITION  
RESISTORS



Resistance  
and Wattage  
marked on  
EVERY UNIT

Here is a new composition resistor — tiny but exceptionally rugged. Not only color coded, but individually marked for quick identification. *Little Devils* are sealed and insulated by molded plastic. They dissipate heat rapidly, have a low noise level and low voltage coefficient, are light, compact, and easy to install. Millions of these units have proved their value in critical war equipment. Available from stock in Standard RMA values from 10 ohms to 22 megohms. Tolerance  $\pm 10\%$ .

Available only from Ohmite Distributors  
**OHMITE MANUFACTURING CO.**  
4895 Flournoy St., Chicago 44, Ill.

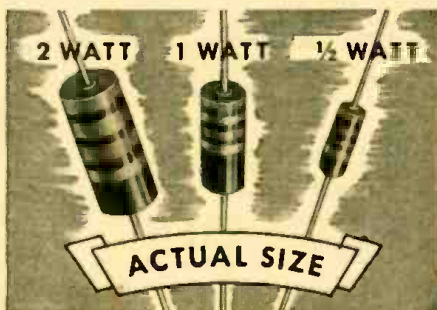

Send Now for  
Bulletin No. 127  
Gives complete data and  
list of RMA values. Includes  
dimensional drawings and  
handy color codes.



Be Right with...

**OHMITE**  
RHEOSTATS  
RESISTORS • TAP SWITCHES

## WORLD-WIDE STATION LIST

(Continued from page 857)

Location	Station	Frequency and Schedule	Location	Station	Frequency and Schedule
Paris		9.540 midnight to 12:15 am; 12:30 to 12:45 am; 1 to 1:15 am	Honolulu	KRHO	17.800 Philippine beam, 4 to 11:30 am
Paris		11.845 8 to 9:45 pm; 10 to 10:45 pm; 11 to 11:45 pm; midnight to 3 am; noon to 5 pm; 5:30 to 7:30 pm	HONDURAS		
Paris		15.350 6 to 8 am	La Ceiba	HRD2	6.235 7:30 to 10 pm
Paris		17.765 6 to 8 am	San Pedro Sula	HRP1	6.357 6 to 7:30 am; 6:30 to 10:30 pm
FRENCH EQUATORIAL AFRICA			TaguaGalpa	HRN	5.875 8 to 10 am; 6 to 11 pm
Brazzaville	FZ1	6.023 4 to 8 pm; midnight to 1:30 am	HONG KONG		
Brazzaville	FZ1	9.440 11 am to 8 pm; mid- night to 2:30 am	Victoria	ZBW	9.495 4:30 to 8:30 am
Brazzaville	FZ1	11.970 11 am to 6:45 pm; mid- night to 2:30 am	HUNGARY		
Brazzaville	FZ1	15.595 4:45 to 8 am	Budapest	HAT4	9.125
Brazzaville	FZ1	17.527 midnight to 2:30 am; 4:45 to 7:45 am; 11 am to 5 pm	ICELAND		
FRENCH WEST AFRICA			Reykjavik	TFJ	12.265 8 to 9 am; 3 to 6:30 pm
Dakar		8.840 afternoons till 4:30 pm	INDIA		
GERMANY			Delhi	VUD3	3.340 11 to 11:45 am
Munich		6.160 11 pm to 2 am	Delhi	VUD3	7.290 7:30 to 10:30 am; 9 to 10 pm
Munich		7.265 11 pm to 2 am; noon to 4 pm	Delhi	VUD8	7.275 6 to 7 am; 11:15 am to 1:15 pm; 6:30 to 7:15 pm; 9 to 10 pm
GREECE			Delhi	VUD4	9.590 5:30 to 7 am; 7:45 am to 3:45 pm
Athens		9.930 heard 1 to 6 pm	Delhi	VUD10	9.670 7:20 to 11:30 am
GUADEL DUPE	SVM	9.930 heard 1 to 6 pm	Delhi	VUD3	15.280 6 to 7:15 am
Pointe-a-Pitre	GRAH	7.215 6 to 7:30 pm	Delhi	VUD10	17.830 5 to 7 am
GUAM	KUSQ	8.140 heard at 7 am	IRAN		
Guam	KUSQ	9.330 8 am	Teheran	EQB	6.155 9 am to 2:30 pm; 8 to 8:30 pm
Guam	KUIG	10.510 heard calling NBC around 5:30 pm	IRAQ	EQC	9.680 noon to 2:30 pm
Guam	KUSQ	12.255 5 am; 7 pm to midnight	Bagdad	HNF	9.800 8 am to 3 pm
Guam	KUSQ	15.920 7 pm to midnight	IRELAND		
GUATEMALA			Athlone		9.595 4:10 to 4:30 pm
Guatemala City	TG2	6.220 6 to 11 pm	ITALLY		
Guatemala City	TGWB	6.465 8 am to noon; 6:30 pm to 1 am	Milan	AFRS	6.135 11:30 am to 4:30 pm
Guatemala City	TGWA	9.685 Sunday evenings	JAPAN		
Guatemala City	TGWA	15.170 daytime transmissions	Tokyo	JZ1	9.535 6 to 7:15 am
HAITI			Tokyo	JVW2	9.675 2 to 5 am; 5:30 to 7:15 am; 7:30 to 9:40 am; 9:55 to 11:40 am; noon to 1:40 pm; 4:30 to 7:45 pm
Port au Prince	HHCM	6.165 5 to 8:30 am; 11 am to 2 pm; 5 to 9 pm	Tokyo	JVW3	11.725 heard at 1 pm
Port au Prince	HIBM	9.060 5 to 8:30 am; 11 am to 2 pm; 5 to 9 pm	Tokyo	JZ1	11.800 8 to 9 am
HAWAII			Tokyo	JVU3	11.897 5:45 to 11:30 am
Honolulu	KRHO	6.120 Oriental beam, 4 to 9:45 am	Tokyo	JZK	15.195 heard at 7:30 pm
			Tokyo	JTL3	15.225 5:15 to 7:15 pm
			Tokyo	JLP2	15.325 10:45 pm to 3 am
			LEBANON		
			Beirut	FXE	8.030 11 pm to 5:30 am
			LUXEMBOURG		
			Luxembourg	MCH	6.020 midnight to 3:30 am; 5 to 8:30 am; noon to 6 pm
			Luxembourg	MCH	9.610 irregular
			MARTINIQUE		
			Ft. de France		9.705 heard at 5:30 pm
			MALAYA		
			Singapore		7.220 11:30 pm to 1:30 am; 3:30 to 5 am; 5:30 to 10:35
			Singapore		9.548 8 to 9:30 am
			Singapore		11.855 8 to 9:30 am
			MEXICO		
			Guadalajara	XEJG	4.820 heard at 8:30 pm
			Mexico City	XEBT	6.000 8:45 am to midnight
			Mexico City	XEW W	9.500 8 am to 2 am
			Mexico City	XERQ	9.540 evenings
			Mexico City	XETT	9.535
			Mexico City	XEYU	9.600 late afternoons and eve- nings
			Mexico City	XEQQ	9.680 evenings
			Mexico City	XEUW	11.950 evenings
			MEXICO		
			Mexico City	XEUW	6.023 7 am to 12:45 am
			MOROCCO		
			Rabat	CNR3	9.082 2 to 5 pm; midnight to 3 am
			MOZAMBIQUE		
			Marquis	CR7BH	11.719
			NETHERLANDS		
			Eindhoven	PCJ	9.590 2 to 3 pm; 8 to 9 pm
			NETHERLAND INDIES		
			Bandoeng		5.400 early mornings
			NEW CALEDONIA		
			Noumea	FK8AA	6.205 2:30 to 4 am; 4:30 to 5 am
			NEWFOUNDLAND		
			St. Johns	VONH	5.970 10 am to 2 pm; 3 to 10 pm
			NEW ZEALAND		
			Wellington	ZLT7	6.715 4:25 to 4:45 am
			NICARAGUA		
			Managua	YNDS	6.760 8 to 10 am; 5 pm to midnight
			Managua	YNQW	6.910 3 to 10 am; 1 to 11 pm
			Managua	YNBH	7.008 6 to 10 pm
			NOVA SCOTIA		
			Sydney	CJGX	6.010 5 pm to midnight
			Halifax	CHNX	6.130 7 am to 11 pm
			PALESTINE		
			Jerusalem	JCKW	7.220 10:30 pm to 3 pm
			PANAMA		
			Panama City	HP5H	6.122 6 to 10:30 pm
			Panama City	HP5A	11.690 7 am to 11 pm
			Panama City	HP5G	11.730 daytimes and evenings
			PERU		
			Lima	OAX4Z	5.895 4:30 to 11:30 pm
			Inca	OAX5C	9.785 evenings
			PHILIPPINES		
			Manila	PY	9.395 5 to 7 am; 11 to 11:30 pm
			Manila	PY2	11.646 6:30 to 7:15 am; eve- nings
			PORTUGAL		
			Lisbon	CSX	6.370 3:30 to 7 pm
			Lisbon	CSW7	9.735 7 to 8 pm
			Lisbon	CSX	11.995 7 to 9 am
			Lisbon	CSW	12.070 heard 1:30 to 3 pm

Install your aerial

THE  
**VERTROD**  
WAY

As MODERN as the electric  
refrigerator, compared with  
the old ice box.

VERTROD — vertical models  
eliminate poles — insulators —  
lightning arresters — filters —  
hanging aerial wires — climb-  
ing.

VERTROD — 20 models cover  
all wave reception — FM — AM  
and Television.

VERTROD — the most perfect  
scientific development ap-  
proaching complete freedom  
from man made static.

The VERTROD way (with pa-  
tented features) is the modern  
way. At most radio shops.

WRITE FOR FOLDER 401

**VERTROD**  
CORPORATION

60 EAST 42nd STREET  
NEW YORK 17, N. Y.

## AUDIO MIXER DESIGN

(Continued from page 835)

It should be noted here that standard procedure must be followed in all equipment patching, especially if the circuit into which the patch is being inserted is already in use.

Correct procedure is to insert the "cold" end of the patch-cord first, that is, to complete all composite patching, and then patch from the composite output to the required input circuit, never in the reverse manner. The tip of a patch-cord plug is momentarily shorted as it passes through the grounded frame of the strip jack, and if the opposite end of the cord is energized, the result is unnecessary interruption of the program.

An example of a straightforward control panel is shown on page 835. It is the conventional type used at most average broadcast stations, in which key switches and variable attenuators are used in each mixing position. Beginning at the extreme left of the panel, at least four channels are provided for microphones, a minimum of two for transcription reproducing equipment, one for network, one or more for remotes, and one position left as a master mixer. A line-reversing switch to reverse the input and output of the network amplifier when feeds originate locally may or may not be located on the console, depending on individual needs. Utility, talk-back, line and monitor cue keys are provided as desired. Indicating lamps provide visual indication of control.

The line key energizes a set or bank of relays which connect the program amplifier to the broadcast loop, operate an "On the Air" studio light, and energize a "Standby" light at Master Control. Operating the proper studio key at Master Control lights an indicator lamp in the control room, completes the loop circuit and places the studio "On the Air".

With a Talk-Back key, conversations may be carried on between the studio and control room. This is done only when the studio line key is not energized (at rehearsal times) to avoid the possibility of program cross-talk. In some cases, where the talk-back unit is included as a part of the studio control circuit, the entire talk-back unit is rendered inactive by operation of the studio line key, and remains so as long as the studio is "On the Air". In other systems, a patch-cord is used to complete the talk-back circuit, and proper usage is left to the discretion of the operator.

The more complex control boards employed in larger stations and in network studios often make use of automatic interlock switching circuits, by means of which any number of separate or composite programs may be pre-set and automatically switched in at the proper time. Individual cue or monitor positions are provided whereby program levels, quality, and the required amount of line equalization may be quickly determined prior to air time.

# PREPARE FOR THE

## *New Opportunities*

# in RADIO ELECTRONICS





... Use Cleveland Institute home study courses for professional self-improvement.

## CLEVELAND INSTITUTE OFFERS—

1. **Mathematics for Radio and Communication Engineering.**
2. **Advanced Course in Radio Communication Engineering.**  
A college-level Radio Engineering Course.
3. **Master Course in Radio Communication.**  
Covers fundamentals of Radio and includes complete preparation for FCC Commercial License Examinations.
4. **Specialized Television Engineering.**  
Including post-war Television Techniques.

*All Courses Include*

**The Remarkable Workbooks of Instructional Aids, prepared by the instructing staff of Cleveland Institute.**

Choose the course best suited to your needs—Start with the section you are qualified to enter—Use the economical CIRE "Pay-As-You-Go Plan."

*Write for descriptive folder.*

## CLEVELAND INSTITUTE OF RADIO ELECTRONICS

Contractors to the Canadian Broadcasting Corporation

Successors to

**NILSON RADIO SCHOOL**  
Founded 1939

**SMITH PRACTICAL RADIO INSTITUTE**  
Founded 1934

RC-9 TERMINAL TOWER, CLEVELAND 13, OHIO

Approved for Veteran Training Under "G-1 Bill of Rights"

(MAIL THIS COUPON)

Cleveland Institute of Radio Electronics, RC-9 Terminal Tower, Cleveland 13, Ohio.  
Gentlemen: Please send information about your home study courses in Radio Electronics.

NAME .....

ADDRESS .....

CITY .....

ZONE ..... STATE .....

I desire training in .....

I have had experience in broadcasting  servicing

operating  mfg.  CAA  Army-Navy

amateur  other .....

I am a High School Grad.  College  Degree .....

Check here for Veteran Enrollment Information.

## ROTA-BASE

**NEW HANDY LAB. DIAL.** Simply turn the movable dial to the tube number desired on the ROTA-BASE and complete, correct connections are instantly indicated on the "prong" diagram. Filament, grid, plate, cathode, etc., to more than 300 tube types are given. No more valuable time lost on lengthy reading or thumbing of pages. ROTA-BASE actually gives a "prong" picture of the connections. **PRICE NOW ONLY \$1.00.** Postage prepaid or sent C.O.D. plus postage. Money back if not delightfully pleased.

**REED MFG. CO.** 411 S. Main St.  
Los Angeles, Calif.

**CRABTREE'S**  
**WHOLESALE RADIO**

2608 Ross Ave.  
**DALLAS 1 TEXAS**

## ELECTRONIC VOLT-OHMMETER

**\$1185**

**110 VOLTS AC 20 RANGES**

**POSTPAID** 0/5/10/50/100/500/1000/5000 volts DC and AC. 0-1,000,000,000 ohms in six overlapping ranges. Sensitivity: over MILLION OHMS per VOLT on 5 volt range.

Complete kit includes all component parts, tubes, punched and drilled chassis and beautifully enameled panel. Easily assembled and wired.

Special all-back circuit developed during war by scientist at the California Institute of Technology gives amazing sensitivity and flexibility while completely eliminating necessity of batteries and expensive meter. Each instrument is individually calibrated. Dial scale over nine inches long!

In addition to performing the usual volt-ohm functions, this instrument easily measures these voltages: SUPER-HET OSCILLATOR, AVC, AFC, TRUE GRID BIAS AT THE GRID, BIAS CELLS without affecting the circuit. Measures the exact leakage resistance of INSULATION, TUBES, CONDENSERS. It can be used with a signal generator for SIGNAL TRACING.

**STERLING ELECTRONIC COMPANY**

166 N. Sierra Bonita Ave., Dept. 2, Pasadena 4, Calif.



**FREE**

# Have You Seen The Solar System?

It's a bi-monthly magazine of authoritative information on new developments in the capacitor field. Simply fill in the coupon below if you'd like to receive this easy-to-read

technical publication regularly at your home or at your office.



1689

RC

Solar Manufacturing Corporation  
285 Madison Avenue, New York 17, N. Y.

Gentlemen: Please send me the SOLAR SYSTEM regularly, starting with the current issue.

Name.....

Address.....

City.....

Zone No. ....

State.....

## A LABORATORY QUALITY OSCILLOSCOPE For the Service Man . . .

Portable, sturdy, compact—the CRO-5A is an ideal unit for rapid, accurate, high quality service work. Check the utility and features which you have always wanted in the instrument on your bench.

- For better laboratory and production testing . . .
- For routine Service work . . .
- For studying any variable which may be translated into electrical potentials by means of associated apparatus . . .
- Designed with tubes for maximum amplification with minimum noise . . .
- Exceptionally stable trace even under adverse power line variations . . .
- Frequency response—essentially flat from 20 cycles to 350 KC . . .
- Completely self-contained . . .

Write to General Electric Company, Electronics Department SRC-6407, Syracuse 1, New York.



CRO-5A

**GENERAL ELECTRIC**

177-E2

### TELEVISION FOR TODAY

(Continued from page 840)

tube. See Fig. 4. With a low value shunting resistor,  $Z_1$  of the expression:

$$\text{Gain} = G_m \times Z_1$$

becomes low and with it, the gain. Incidentally, this equation demonstrates why high  $G_m$  values are desirable.

Sometimes designers use elaborate interstage coupling networks to achieve the desired selectivity without lowering the gain by excessive resistor loading. Two such possible coupling units between the r.f. stage and the mixer are shown in Fig. 5. The variable condensers in these tuning circuits are of the trimmer variety, pre-set by the manufacturer. For each station a separate unit is connected into the circuit by the station selector, which may be of the push-button or rotary type. Tuning of the type employed on the majority of sound receivers is manifestly impossible for television with its 6 mc bandwidth. Imagine the confusion of a layman trying to center the station with 6 mc to play around in. Hence the pre-set push-button or rotary type of tuning. Fig. 6, printed by courtesy of the

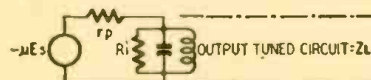

Fig. 4—Equivalent of tube output circuit.

American Television Laboratories, shows the switching arrangement of a television receiver.

### CONVERTERS AND MIXERS

To take advantage of the benefits of the superheterodyne, it is necessary to convert the incoming signal to the lower intermediate frequency. For this we have *converters*, where the mixing and the oscillator voltage generation are confined to one tube, or *mixers*, with a separate oscillator. If we attempt to use any of the conventional pentagrid converters (6A7, 6A8, 6D8, 6L7, 6SA7) undesirable interaction occurs between signal and oscillator. This generally becomes noticeable at about 60 mc, with the result that not only does the oscillator output voltage vary, but more im-

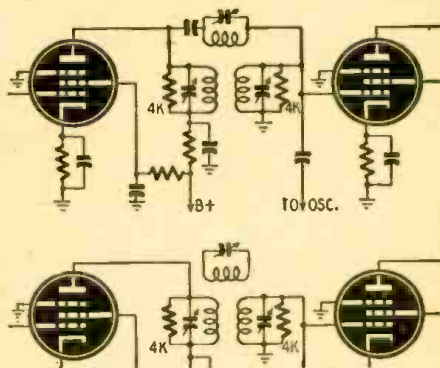

Fig. 5—Two methods of coupling r.f. stages.

portant, the oscillator frequency. More desirable, but still not totally satisfactory, is the triode-hexode converter, the 6K8. Here the oscillator voltage is developed in a separate section of the



# Exclusive at Newark! SURPLUS SPECIALS

**MOBILE 40 & 80  
METER XMTR-  
RCVR SET  
FAMOUS MARK II  
ONLY \$34<sup>50</sup>**

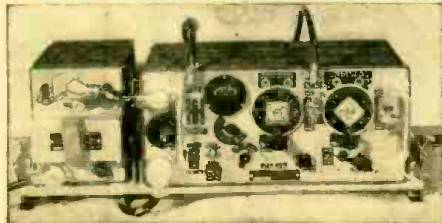

Hams! It's unbelievable but true! You can now own a complete 40 and 80 meter mobile rig for only \$34.50. Here's what you get: Two sets in one. Phone and CW on 2 to 8 Mc (Right Smack in the 40 and 80 meter bands!) 6 tube Super Receiver, 6 tube MOPA Xmtr. Also, a complete 235 Mc transceiver. Included in this wonderful buy is: 1 pair headphones, 1 key, 1 "A" set antenna with

variometer, 1 "B" set antenna, 1 control box, 1 microphone, 1 Dynamotor power supply kit, plus all the plugs, cable connectors, etc., that are needed for operation. And this rig can take it. It was originally designed for tank operation. Remember: Nothing else to buy. You're on the air with a mobile job you've been longing for. AT THIS SENSATIONALLY LOW PRICE

**BRAND NEW DYNAMOTOR  
POWER SUPPLY**

Don't confuse this fine apparatus with second hand surplus now on the market. It's brand new, in original Signal Corps Carton.



Supplies 500 volts at 160 mils DC from any 6 volt or 12 volt battery source. A typical Newark VALUE! **\$14<sup>95</sup>**

**EICOR DYNAMOTOR**

Ideal for your mobile rig. Each unit brand new and fully guaranteed. This dynamotor has two windings which deliver the following voltages:  
12 VOLT INPUT DELIVERS { 500 volts at 50 mils  
  { 275 volts at 110 mils  
A compact, sturdy motor used by U. S. Army. Weighs approx. 6 lbs. Size: 7 1/2" l x 4 3/4" w x 4 3/4" h.

**A TERRIFIC BUY FOR ONLY \$4<sup>95</sup>**

**HAMS! EXPERIMENTERS!  
make a 10 Meter FIELD  
INTENSITY METER from this  
Signal Corps Test Set!**

Unusual instrument, offers wonderful possibilities for very high frequency work. Meter alone (0-250 RF mils) worth more than price of complete unit. Only a few left. **BRAND NEW!** Sale Price **\$9<sup>95</sup>**



**OUR PLEDGE  
NEWARK WILL HOLD THE  
LINE ON PRICES OF ALL  
SURPLUS AND REGULAR  
MERCHANDISE**

**WRITE FOR  
FREE FLIERS  
AND CATALOGS**

**NEW YORK** 115-17 W. 45th St., New York 19, N. Y. **CHICAGO** 323 W. Madison St., Chicago 6, Ill.  
Branch: 212 Fulton Street, New York 7, N. Y.

**NEWARK  
ELECTRIC CO., INC.**

tube (See Fig. 7). This, to some extent, shields the oscillator from the direct influence of the signal.

The best solution is the use of a separate oscillator (generally a triode) and a pentode mixer. Not only does this completely separate the two from each other, but it permits the use of a pentode for a mixer, with a subsequent decrease in noise level. With conventional design, the amount of noise generated in a pentagrid converter, as compared with a pentode, is in the ratio of 4 to 1. Thus, the converter sets a higher minimum level and naturally lowers the sensitivity of a receiver. As far as noise is concerned, triode mixers would represent an even better choice than pentodes, but when we consider the problem of regeneration due to  $C_{cp}$ , we find that pentodes are more desirable.

When a separate mixer tube is employed, the injection of the oscillator voltage may be made at the control grid, cathode, screen, or suppressor grids of the pentode. The most likely place is the cathode permitting simultaneous control of both the grid and plate circuits. Another good point of injection is at the control grid, although not as favorable as the cathode. The remaining two grids, screen and suppressor, are seldom used because of the increased driving voltage required. Several typical coupling circuits for control grid and cathode injection are shown in Fig. 8.

#### TYPES OF OSCILLATORS

Four common circuits have been used for the oscillator in the majority of

sets. These are the familiar Hartley; its modification, the electron-coupled Hartley; the tuned-grid tickler oscillator and the Colpitts (or a modification, the ultraudion). In previous commercial models, the 6J5 has been widely used, although any tube possessing low internal shunting capacities, a high value of  $G_m$  and ability to function at the higher frequencies is suitable. Triodes are preferred because they require but one regulated voltage; pentodes need two. The switching arrangement in the oscillator section of Fig. 6 is a good ex-

ample of how various coils and small trimmer condensers are tapped in with each change of frequency. These units are all pre-set and tune the oscillator to the proper frequency for each band.

Great stress is given to oscillator stability, because in a television set, recommended stability of  $\pm 0.01$  percent *must be maintained*. Nothing is more annoying than to see the image become distorted due to a shifting oscillator during the course of a broadcast. Because the main tuning control is fixed, (Continued on page 870)

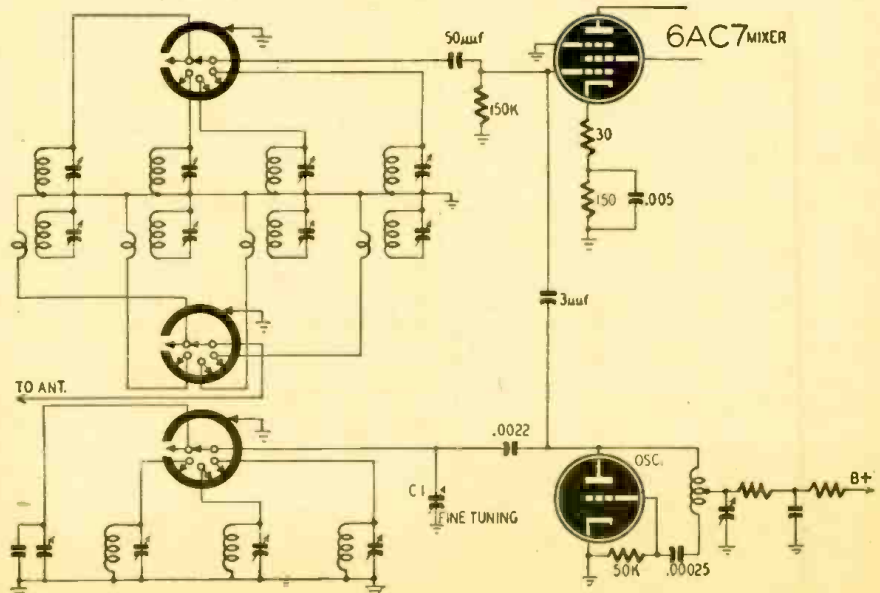

Fig. 6—Switching arrangements for tuning a modern four-channel television receiver.

# MONEY-SAVING SPECIALS

Just a few items selected at random from our tremendous stocks. Order direct from this ad and save time. If you don't see just what you want, write for our latest bulletin of money-saving specials.

## Meter and Tester Bargains

M1—G.E. 0-10 A.C. Voltmeter 3/4" Rectangular	\$ 3.94
M2—McLintock 0-300 D.C. Milliammeter 3/4" Rect.	3.93
M3—McLintock 0-500 D.C. Milliammeter 3/4" Rect.	3.93
M4—McLintock 0.15-150-300 D.C. Milliammeter 3/4" Rect.	6.90
M5—G.E. 0-1 R.F. Meter 2 1/2" Diameter	4.92
M6—Marion 0-1 Standing Wave Meter 3/4" Round	3.93
PB-100—Superior Volt-Ohm-Milliammeter	28.40
PB-210—Superior Volt Ohm Milliammeter	35.75
M-400—Superior Vacuum-Tube Voltmeter	52.50
W-665—Weston Selective Analyzer	58.50
F-TS2—Feiler Signal Tracing Analyzer	29.50
CA-11—Superior Signal Tracer	18.75
F-1—Feiler Signal Tracer	9.85

## Wire and Cable

HPI—Hookup and Pushback Wire, 100' hanks, each	.89
Hookup and Pushback Wire 10 hanks assorted colors	7.80
HP2—Hookup Wire Odd lengths 2 lb. pkg.	1.39
EN3—Enamelled wire No. 26-28-30-7b. spools, No. 22-24 1/4 lb. spools	.89
CC4—D. Cotton covered enamelled wire No. 16, per lb.	.79
SC1—Single Shielded for phono pickups, etc. 100'	2.49
SC2—Single Cond. Shielded wire 100'	3.49
MC1—Microphone cable—shielded rubber covered, odd lengths 6 to 40', per foot.	.05
MC50—Microphone Cable—50' lengths, \$2.95—100 feet	5.75
MC2—Microphone Cable—2 Cond. Rubber covered, odd lengths 6 to 40', per foot	.08
MC250—Microphone Cable—2 Cond. 50' lengths 100' lengths	4.95
MC4—1 Cond. Shielded Rubber cov. cable, 100 ft.	8.75
MC8—8 Cond. Shielded Rubber cov. cable, per 100 ft.	10.95
TV2—2 Cond. twisted Vinylite No. 22 wire, per 100 ft.	16.95
CC—Coax cable 50 Ohm, per foot	12.50
CD—Coax cable 100 Ohm, per foot	.10
	.12

## Servicemen's Kits

No. 1S—12 popular speaker cones—5" to 12" with V.C.	Kit	4.95
No. 2K—50 Assorted Bakelite Knobs all set screw.	Kit	4.75
No. 3N—100 Assorted knobs—push on & set screw	Kit	6.95
No. 4C—100 Assorted By-pass and Buffer Condensers, Total value over \$20.00 Our price only		5.82
No. 5R—50 Assorted 5-10 & 20 Watt Resistors		5.95
No. 6C—100 Carbon Resistors—25 1W 75 1/2 W		2.94
No. 7C—200 Assortment 1/4 W Carbon Resistors		3.95
No. 8C—200 Assortment 1/2 W Ins. Resistors		4.95
No. 9P—50 Assorted paddlers and trimmers		2.95
No. 10E—50 Assorted Electrolytic Condensers		10.95

## Transformers

29P—Power Transformer 6.3V 3 Amp. 5V 2 Amp. 120V input, 650V 90M.	2.95
30P—5V—6.3V—600 V 100M	2.95
31P—Crosley 1014—10-tube Power Transformer	2.95
320—20 Watt Output Transformer GLG—etc.	1.69

## Tube Bargains for Hams

307	\$.170	829B	\$.890	2AP1	\$ 4.90
807	1.90	9001	2.45	5BP1A	12.45
866	1.45	9002	1.95	5FP7	9.95
954	4.90	9003	2.45	5R4G7	1.80
955	2.90	9004	1.95	6AK5	1.69
8005	4.90	9006	.94	7BP7	14.90
8025	8.90			VR-105	1.37

We have one of the largest tube stocks in the country. Write for our list of tubes available for immediate shipment. Write for Latest Bargain Bulletin showing hundreds of items for servicemen and amateurs. Our stock is improving . . . new items being received every day.

**Lifetime**  
SOUND EQUIP. CO., Dept. 21  
911-913 JEFFERSON AVE., TOLEDO 2, OHIO

## V.H.F. RECEIVER

(Continued from page 825)

regeneration control, the standby switch, pilot light and the volume control, are drilled in a row along the bottom of the panel one inch up from the lower edge. These should be placed symmetrically to maintain a good front-panel appearance. The holes for two 10-32 oval-head screws that secure the panel to the chassis should be drilled along the same line, one inch in from either side.

A hole 2 inches in diameter is then cut in the panel. This should be centered and 2 7/16 inches from the top edge. The mechanism from an old National Velvet Vernier dial with the dial removed is then installed in this 2-inch hole and secured with four 3/8-inch, 6-32 flat head machine screws. This allows the movable part of the dial to come out flush. A lucite pointer may be attached to this part with the three original screws. The panel then may be given two coats of flat black enamel allowing ample time for drying between coats. An escutcheon plate similar to the one used should now be made of thin sheet brass stock and also given a coat or two of flat black. The dial card (of draftsman's Bristol Board or a good quality index card) should be made of ample

might be used if polystyrene is not available. Details of the modification are pretty clearly shown in the photograph. Fig. 2 and Fig. 3 give drilling details and provides a full size pattern for both

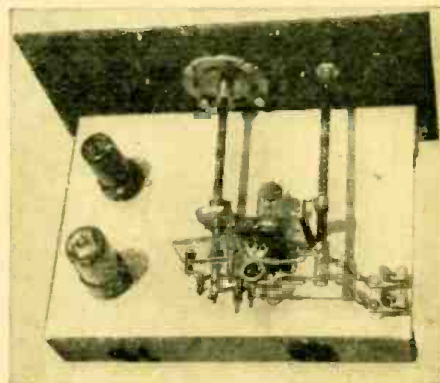

This view presents the parts layout clearly.

rotor and stator plates. As shown in Fig. 2, new stator plates were cut out of thin sheet aluminum to get the maximum capacity possible, since we weren't sure how much would be necessary for the coverage desired. This accounts for the difference in the shape of the stator plates as used and the originals. Either may be used.

Using a set of two stator plates and one rotor plate with single spacing, satisfactory bandspread was achieved in our receiver. This combination with the coils as constructed gave ample spread for the two meter band. If the builder plans to use the 1 1/4 meter band he may prefer to double-space the capacitor and make the coil somewhat larger to get greater bandspread.

The photos and Fig. 2 show how the coils are mounted across the stator plates for short connections. The tube socket is directly behind the coil, mounted on a small aluminum bracket. The antenna coupling assembly is two Fahnestock clips mounted on two small stand-off insulators. Flexible leads connect to

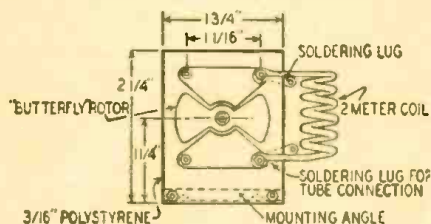

Fig. 2—Details of "butterfly" tuning unit.

size to allow for the swing of the pointer and to match the escutcheon plate. The card we used when trimmed measured 2 1/2 x 4 3/8 inches and the escutcheon was made to match this size. Two or three half-circles may now be drawn on the card for calibration purposes. If carefully handled this home-made dial will present an appearance that will match that of a commercially-made unit and should be presentable in the most finished station.

The chassis should now be prepared by making the socket holes for the two audio tubes on the top and that for the five prong socket on the rear. Two 5/16-inch holes are drilled for two banana jacks on the rear of the chassis near the 6K6 socket, for speaker connections. The detector section construction may well be started by the dismantling of a Cardwell tuning condenser, type ZR-15AS. This is a midget, single bearing rotor type and lends itself well to revision since it is assembled with machine screws and nuts. The original steatite base may be used as a template for drilling a piece of polystyrene for a new base. This material is preferable due to its low loss characteristics at very high frequencies but the steatite

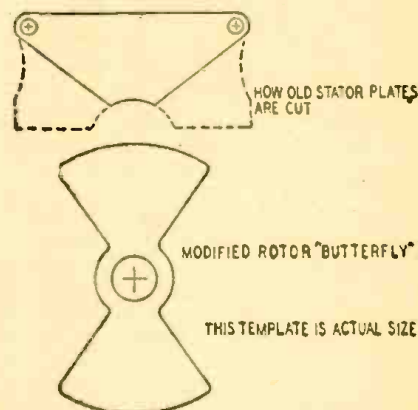

Fig. 3—"Butterfly" capacitor plate patterns.

the movable shaft which holds the two-turn coupling loop. This coupling loop is mounted on a small piece of polystyrene tubing with two small machine

# RHS SPECIAL FALL CLEARANCE SALE!

## PORTABLE TRANCEIVER, NAVY TBV

28-80mc (5 and 10 meter bands). Complete with phones, mike, 8 tubes, crystal and key. Slightly used, fine condition. Wonderful buy ..... **42.50**  
 Vibrator & storage battery power supply for above ..... **\$19.95**

## WESTON MODULATION METER

Mod. #301-3" AC rectifier type 1000 ohms per volt. Super value at ..... **3.95**

## NATIONAL DRIVE PW-O

Exceptional buy at ..... **2.95**

## 3 mc I. F. COIL KIT

contains 1-input, 1-interstage and 1-discriminator all shielded. Set of three coils ..... **1.98**

## OIL CONDENSERS: GE., AEROVOX, C.D. etc

2mfd 600v.....60c	1mfd 2000v 95c
4 " " .....75c	4mfd 2000v \$3.95
8 " " .....\$1.10	10 " " .....\$4.35
4 " 1000v \$1.10	1 " 3000v \$3.95
8 " " .....\$2.00	.1 " 7500v \$3.95

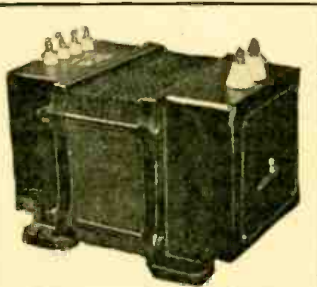

## AMERTRAN HEAVY DUTY PLATE TRANSFORMER

The ideal unit for 1000 watts Prim. 105-115v 60 cycle Sec. 3100-0-3100, full voltage across sec. 6200v at 700 ma. **\$39.95**  
 Our Price .....

## 100W DUMMY ANTENNA

### LOAD FOR 80 METERS

Metal box contains Millen 150 mmf. Var. condenser .077 spacing. Iso/antite base, easily split stator. Many uses. **\$2.98**  
 Special at .....

## TRANSMITTER SHELF T66CRN-10

Complete RF section uses 1-807 Crystal oscillator tripler, 1-807-RF doubler, 1-257B, RF tripler, driving 2-257Bs RF amplifier in push pull, 1-6H6 RF output indicator. All volts and current read on 2 Weston meters through panel switch. Now on 110mc. Slight change to 144mc. Capable 500 watts output. Less tubes and crystal. Reduced to ..... **39.95**

## OSCILLOSCOPE KIT

5CP1 Cathode ray tube.....ea.	<b>6.95</b>
Socket for 5CP1.....	<b>1.98</b>
Anode button for 5CP1.....	<b>.35</b>
Shield for 5CP1.....	<b>1.49</b>
2X2A Rectifier tube.....	<b>1.25</b>
Plate cap for 2X2A ceramic.....	<b>.25</b>
Socket for 2X2A ceramic.....	<b>.20</b>
Xformer, 1700v, 6.3v, 2.5v 110v 60 cycle.....	<b>6.50</b>
Condenser, oil .5-2000v.....	<b>2.10</b>
Order Separate or Complete Kit, SPECIAL.....	<b>16.95</b>

## TUBES: NEW JAN APPROVED

6C4 ..... .75	6AL5 ..... .75	5BP4 ..... 8.95
6J6 ..... .85	6AG7 ..... 1.25	9002 ..... .69
866 ..... 1.19	6AK5 ..... 1.60	9003 ..... .69
813 ..... 9.95	6AC7 ..... .95	1625 ..... .79
1629 ..... .79	257B ..... 14.95	872A ..... 3.50

**ALL MATERIAL IS NEW AND GUARANTEED UNLESS OTHERWISE STATED**

Please Specify Dep't "RK" When Ordering. 20% Deposit Required With All Orders.

**RADIO HAM SHACK Inc., 63 Dey St., New York 7, N. Y.**

EXPORT DIVISION: WESTERN INTERNATIONAL,

168 WASHINGTON ST., NEW YORK 6, N. Y.

screws, and this in turn is mounted on the end of the movable shaft which is a 5/8-inch length of 1/4-inch bakelite rod. In similar fashion the tuning capacitor is coupled to the dial using a 2 3/4-inch length of the same rod and a Millen flexible coupling made of steatite. By having the tuning assembly at the rear of the chassis body capacity effects are eliminated. The r.f. choke is home-made and is shown in the photo, below the tuning coil. It is made by winding 16 turns of No. 24 enameled wire on a 1/4-inch form and removing the form afterward. Tin the ends of the wire and solder it directly to the soldering lug on the grid stator plate.

In wiring it is excellent practice to connect up all heaters first, then the cathodes and then the rest of the audio components. When wiring the detector section, keep in mind that short leads are imperative in very-high-frequency circuits, since only a fraction of an inch here and there will add up to sizeable values of inductance and capacity when the whole circuit is considered. For instance, the plate of the tube is connected to the stator by a 1/4-inch wire and the grid is tied to its stator by direct connection to the capacitor and its grid leak.

The coil for the two-meter band is made by winding 6 turns of No. 20 tinned copper wire on a 3/8-inch form and then removing the form. The turns are then spread to occupy about 5/8-inch in length. The 1 1/4-meter coil is made with  
 (Continued on following page)

# FREE!

**OLSON gives you the famous EVERSARP PEN and PENCIL SET**

*It's guaranteed forever. It's yours without charge, to prove that OLSON RADIO WAREHOUSE gives the radio service-man more for his money and something besides!*

**HOW TO GET YOUR SET:** With every purchase made from us, we will send you "Olson Pointers" (profit-sharing certificates) according to the dollar value of goods shipped. Thus, an \$18.45 purchase brings you 18 "Olson Pointers"; \$4.70 worth of parts brings you 4 "Olson Pointers", etc. When you have saved 100 "Olson Pointers", send them to us and you will receive the Eversharp Pen and Pencil Set FREE, packed in a beautiful gift box!

OLSON gives you value: our prices are lower. OLSON gives you service: we ship same day order is received. OLSON gives you quality: we sell nationally known products. OLSON appreciates your business: we thank you with premiums.

*Do you get our BUYING GUIDES regularly? Use the coupon below.*

**MAIL TODAY**

## OLSON

# RADIO WAREHOUSE

73 E. MILL ST., DEPT. 42, AKRON, OHIO

I want to start saving "OLSON POINTERS."

Send me your Free BUYING GUIDES regularly.

NAME.....  
 ADDRESS.....  
 CITY..... STATE.....

# SPECIAL

## COMBINATION OFFER

Surplus—New—Guaranteed



VARIAC General Radio type 200 CU, 860 volt-ampere rating, 115 volt input, output variable from 0 to 135 volts at a maximum current of 7½ amperes. Comes complete with knob as pictured above. Shipped in original G.R. carton.

VOLTMETER, Westinghouse Model BA-33, 2½", round flush, flange mounted, 0-150 volts A.C.



### PORTABLE A.C. AMMETER

WESTON MODEL 528. Dual Range 0-3 Amp. and 0-15 Amp. full scale for use on any frequency from 2 to 500 cycles. The ideal instrument for all commercial, industrial, experimental, home, radio, motor and general repair shop testing. Comes complete with genuine leather, plush lined carrying case and a pair of test leads. A very convenient pocket sized test meter.

"DONUT" TYPE CURRENT TRANSFORMER, to be used in conjunction with above meter. This transformer extends the ranges of the meter to 0-15 and 0-90 Amperes making it four range A.C. Ammeter Diagram furnished showing simple operation of the above meter-transformer combination.

All four above units included in our

**SPECIAL COMBINATION OFFER ONLY . . . \$24.50**

25% deposit on all C.O.D. orders.  
All shipments sent Ry. Exp. Coll.

### MARITIME SWITCHBOARD

336 Canal St., New York 13, New York

## V.H.F. RECEIVER

(Continued from page 867)

three turns and spread to approximately ⅜-*inch*. These will undoubtedly need adjustment when the receiver is calibrated.

The five-prong socket at the rear of the chassis is for the power connections and would be wired as marked in Fig. 1. A spare prong will be noted. Its purpose is for the use of a power supply with a built-in voltage divider. If one of these (or batteries) should be used the detector voltage may be adjusted to approximately 50 at the 75,000-ohm regeneration control, and the 30,000-ohm dropping resistor is eliminated. The external power supply should be a low power unit capable of delivering 200 to 250 volts at 40 to 50 milliamperes. The speaker used should have an output transformer to match the pentode output tube. An inexpensive 3½-*inch* PM unit gave ample volume and the quality was sufficiently good for speech.

### TUNE-UP AND OPERATION

The power supply may be turned on with the standby switch (SW) in the off position to note if the heaters are correctly wired. The speaker must be plugged into the banana jacks before the high voltage is applied to avoid ruining the screen of the 6K6. When switch SW is snapped to the ON position the superregenerative hiss characteristic of this type of receiver should occur at some point as the regeneration control is advanced. If the set will not regenerate smoothly, some experimentation will be necessary. The radio frequency by-pass capacitor, marked ".001 to .006" in the diagram, should be changed until best performance is noted.

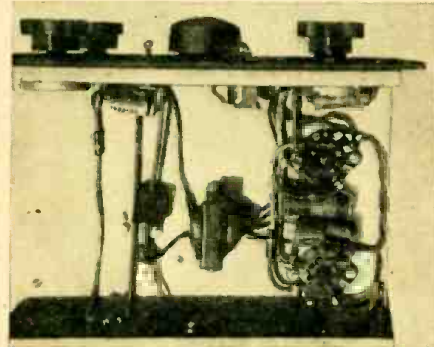

There is little apparatus below the chassis.

In our particular case a 0.002 was best but values from 0.001 to 0.006 should be tried. The by-pass capacitor may or may not be necessary. Values from .05 up to 1 or 2 µf might be used to eliminate the noise from the potentiometer rotor. If audio howl is present the optional resistor will have to be used. Use the largest possible value since smaller values reduce the volume appreciably. Values from 1 megohm down to 50,000 ohms may be tried.

When the receiver "soups" satisfactorily, the band to be used will have to be located. With the proper coil con-

## IN PHILADELPHIA - IT'S ALMO RADIO COMPANY

★ PHILADELPHIA'S  
NEW WHOLESALE RADIO  
AND ELECTRONIC PARTS  
DISTRIBUTOR!

## TUBE SPECIALS

BRAND NEW RCA - KENRAD - GE  
AT DEALERS' O.P.A. PRICES

TYPES	PRICE
27—80—5Y3G	41c
56—5Y4G—26	46c
45	48c
75	51c
6F6GT—6J5—6Q7GT—76—77	54c
6A8GT — 6C5GT — 6C6 — 6D6 6K6GT — 6K7GT — 6SA7 — 6SK7 — 6SQ7 — 6X5GT — 12SA7 — 12SK7 — 36	60c
6C5 — 6H6 — 6SA7GT — 6SJ7 12SJ7	68c
1N5GT — 5Z4 — 6SG7 — 12K8GT — 12SR7 — 83	80c
OZ4 — 1R5 — 1S4 — 1S5 — 1T4 3Q5GT — 5V4G — 6C8G — 6F7 — 6N7 — 6R7 — 6SL7GT — 15Q7 — 14R7	\$1.00
5T4 — 6B4G — 6L6 — 7H7 — 7K7 — 7L7 — 12A6	\$1.22

ALSO HUNDREDS OF OTHER TYPES

### RESISTOR SPECIALS

10 WATTS — 50 — 175 — 300 — 10M — 25M — OHMS	10c
20 WATTS — 2700 — 3500 — 15M — OHMS	12c
25 WATTS — 1000	15c
50 WATTS — 1M — 2M — 3100	18c

MAIL ORDERS FILLED PROMPTLY

# ALMO

## RADIO COMPANY

509 Arch Street  
PHILADELPHIA 6, PA., LOmbard 3-0513

# "TAB"

That's a Buy

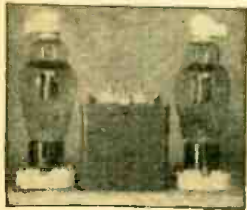

Raytheon 866A filament transformer 115V 60c pri. 2.5Vct 11A Sec and Two new RCA 866A tubes \$5.90 with Millen caps & sockets 7.00 Raytheon Transformer only 3.25

## Transformer High Voltage

Like new 115V-60 C y. S e e 3200V no C. T. \$ 9.00

For that California Killowatt..... \$ 9.00  
For single or P. P. 304TL tubes  
Two units 6400V C. T. wt. 80 lbs. .... 16.00

DC-9AJ Crystal Std. 1000Kc G/Insp. S.C. \$ 5.95  
G.E. Pyranol 2 mfd 4000V wkg. (LP \$55.00)... 4.95  
New W.E. Dynamic microphone D-173340A  
Complete with 50' cable, desk stand or chest plate, feedback reduction attachment, freq. range 50 to 9000 cycles \*TAB Special... 11.95  
With W.E. input mike trans. KS-9450..... 13.95  
Dynamic mike cartridge only D173127..... 4.95  
All 3 units Mike. Transf. rep. Cartridge..... 18.00  
W.E. pp. inpt. tnsf. 100-10000 cy-KS-9448... 2.50  
W.E. pp. input driver 6V6's to pp. 805 grids freq. 100-10000 cy Tnsf. KS-9449..... 4.50  
Both units KS-9448 and KS-9449..... 6.50  
W.E. Vacuum Time delay R1 Relay 115V AC..... 1.49  
W.E. Oil Cond 4mfd 400V wkg. Two for..... 1.00  
Sprague Oil Cond. 4mfd 1500V wkg. Two for 4.50  
CD T/H Oil Cond 6mfd 1500 wkg. Two for 5.95



Complete New Code Practice set in MeElroy AN/OBC-TI operates on 6, 12, 24, 115V DC & 115, 230 V AC for classroom, camp or club Code Practice, gives both visual, blinker and audio adjustable frequency. Loud speaker also earphones connection. Room for phones and keys out-but good for at least 100 students. Brand new G's Insp. Power supply with two Vibrators worth the price alone.

Go'st cost \$197. TAB special \$22.50.  
New S.C. J38 Keys 98c.  
Headphones W.E. 509 HI Imp. 8' CD & PLG \$3.95  
S.C. Headphones with rubber cushions \$1.90.

WE tnsf 115V60cy pri-5V264 sec 15000V Ins. 4.50  
Condor Sprague Oil 10mfd660VAC2000VDCwkg 2.70  
Condor G.E. Pyranol 15mfd660VAC2000VDCwkg 3.90  
Condor F3L-822 Sangamo 002mfd8000V(LP\$32) 3.99  
Condor G.E. 3 mfd 330V AC-1000V DC 2 for 2.50  
Condor Oil & insulators 2mfd2000VDC .2 for 4.25  
AC Voltmtr Wstohse 150V 2 1/2" B.G. 1.98  
Crystal any freq. mtd 2-10mc ea. \$1.51. 4 for 5.90  
WE Crystal IN21-22-23 new lead sealed 3 for 1.50  
Resistor Kit 100 BT 1/2 & 1W. 80 to 2 meohms. 2.50  
Mica Condor Kit-gty Silvermica. 50 for 2.00  
Autosyn Bendix Xmitter & Rev. new G' 2.95  
Autosyn Bendix Hobart 115V-60 Cy. New for 18.00  
Allied Relay BJ 115VAC DPDT 5AMP cts New 1.49  
Allied Relay BO 5000 ohm DPDT 10AMP cts New 1.92  
Magnatron JAN 2132 new Wstohse gtd (S154) 19.95  
WE new IN26 Crystal "K" radar bd ICM 75  
8CPI JAN Insp new with Duo-Diherent socket 7.50  
8CPI JAN Insp new with Duo-Diherent socket 3.95  
GE 3 cond Tinsel "SJ" new rubber cable 100 ft. 1.50  
Mica .01MFD2500V No. 4 (3.40) 2 for 1.00  
ARRL-Radio Amateur Handbook 1946 1.00  
Navy sea trunk 12" x 22 1/2" x 18" used L.N. 3.95  
Hallcrafters MO&XTL HT-4 units SCR299... 2.95  
Butterfly UHF condor with WE 703A socket 3.95  
Kurman adj. 1000CY AC source complete new .97  
Punched Chassis 16 1/2" x 6" W x 3" 35  
Punched Chassis 16 1/2" x 13" W x 2" 65  
Stepping relay 10 pos new S.C.G' 24 to 48 VDC 7.50  
New Xtal rect test set TS-2680 & spare pts 22.50  
New AN/APR-5AX recvr 115V60C Freq 1000 to 6000 mc pkcd over's cases, ant unit & 15 lbs 75.00  
Aircraft JAN vacm relay & solenoid MV & CUR 3.95  
25 assted Allen Bradley J Potentiometers 2.50

## "TAB" Special

Navy TBY portable ultra HI-Freq. 28 to 80 mc's transceiver Voice & CW Spot calibrated, including crystal calibrator, all tubes, adj. ant; phones, mike, carrying case \$49.50.

Additional spare parts, Vibrator supply, Trunk, Antenna, manual and other spares \$25.00.

\$2 Min. orders FOB N.Y.C. Add Postage all orders and 25% deposit. Write for catalog 300. Specialists in International Export, School, College & Industrial trade. Buy thru "TAB" and save.

## "TAB," Dept. D9

6A Church Street, New York 6, N. Y.

nected across the condenser the frequency may be checked by the use of a homemade wavemeter which has been previously calibrated by another receiver already located in the band. Usually some neighboring ham or experimenter will have one of these which he will lend you. This wavemeter should be coupled to the detector coil by bringing them close together. Then tune the wavemeter. When the receiver blocks (goes out of oscillation) the receiver frequency is that of the wavemeter and the reading on the wavemeter dial may be marked on the receiver dial. If the wavemeter is deemed accurate enough the megacycle and half-megacycle points can be marked in.

If no wavemeter is available, the receiver may be roughly calibrated by using Lecher wires to locate the bands and then more closely lined up by listening for marker stations. Data on the construction and use of Lecher wires is outside the scope of this article but was given in the article "144-Mc Transmitter" in the February RADIO-CRAFT. We used a matched impedance type antenna erected at a height of 40 feet above ground, which has given very satisfactory results. There are many types which may be used and we strongly urge the construction of one especially designed for the band that you intend to operate on. An efficient antenna is very necessary on very high frequencies.

While this receiver does not represent the ultimate in its class, perhaps, it should provide good dependable reception and its construction will not present problems too formidable for the average builder.

## RADIO-ELECTRONIC QUIZ

How thoroughly have you mastered the contents of this magazine? Try the following quiz as a test:

1. Would it cost more to produce a good television program or a good moving picture? See page 821.
2. What is the maximum bandwidth that can be handled by an amplifier circuit? See page 822.
3. Is the present shape of television screens theoretically the best one? See page 823.
4. Did our enemies as well as ourselves possess night-sight telescopes for military purposes? See page 826.
5. How do English and American phonograph records differ? See page 827.
6. Is a crystal set confined to purely local reception? See page 831.
7. Where would you look for a "pad" in a broadcast station? See page 834.
8. What is an Ayrton shunt? See page 837.
9. To increase the efficiency of a television receiver, would an extra r.f. or an extra i.f. stage be more desirable? See page 840.
10. At what price are television sets now available? See page 855.

# FREE!

## LAFAYETTE RADIO BARGAIN FLYER!

SEND FOR YOUR COPY NOW!



You can always count on Lafayette's prices to save you real money. That's because we turn over thousands upon thousands of radio parts — like that — just as fast as we get them! Famous brand merchandise priced so low you won't believe your eyes. (When the world's oldest and greatest supplier of radio parts says these are the most unusual bargains in our history . . . you'd better start clipping that coupon . . . below.)

## Here's a buy that's typical

### FILTER CONDENSERS, OIL FILLED

XPS498 2 mfd. 600 v. round. 2 1/4" x 1 1/2" .59  
XPS499 4 mfd. 600 v. round. 4 1/2" x 1 1/2" 1.19  
HR102 6 mfd. 600 v. 4 3/4" x 2 1/2" x 1 1/4" 1.35  
HR104 4 mfd. 1000 v. 4 3/4" x 2 1/2" x 1 1/4" 1.49  
HR103 1 mfd. 2000 v. 4 3/4" x 2 1/2" x 1 1/4" 1.49  
HR105 3 mfd. 2000 v. 4 3/4" x 3 3/4" x 1 1/4" 2.95

# LAFAYETTE RADIO

RADIO WIRE TELEVISION  
NEW YORK • BOSTON • NEWARK

PASTE THIS COUPON ON A PENNY POSTCARD

LAFAYETTE RADIO  
DEPT JI-6 100 Sixth Ave. New York 13, N. Y.

Rush my bargain flyer

Please enter my order for.....

Check enclosed.  Money Order.

Send C.O.D.

NAME .....

ADDRESS .....

CITY.....ZONE.....STATE.....

# HARRISON HAS IT!

## ALL STANDARD LINES

We are **FACTORY AUTHORIZED DISTRIBUTORS** for the top quality manufacturers and we now have in stock lots more new, latest improved production Ham gear. Visit our stores today, for everything you need. We promise you fresh, clean material—quicker—at the lowest current prices—and above all, our sincere desire to be of friendly, helpful service. As one of the world's largest distributors of Communications Equipment, we are delivering plenty of

## RECEIVERS

right now! **ALL MAKES**—practically all models. If you want your new set in the quickest possible time send your order to **HARRISON!**

For example:

- NATIONAL HRO-STA-1.** New model with noise limiter, metal tubes, ham bandspread coils, etc. Complete with pack, speaker, and coils 1.7 to 30 Mc. **\$303.00**
- HAMMARLUND new Super-Pro.** SPC-400-SX, 1.25 to 40 Mc. **\$310.05**
- HALLICRAFTERS—Model S-36-A.** FM-AM-CW with peak performance on 10 and 6 meters, a swell police job, a beautiful high-fidelity FM receiver for both old and new bands, an excellent piece of Lab equipment—all in one! Acorn tube RF section, noise limiter, 15 tubes, 27.8 to 143 Mc. **\$307.50**
- S-37, 130 to 210 Mc. **\$591.75**
- RME 45.** New, revised model with calibrated ham bandspread. **\$186.00**

With speaker **LITERATURE ON ANY RECEIVER GLADLY SENT UPON REQUEST**

The **PANADAPTOR** has earned its acceptance as a decidedly worth-while adjunct to any Ham shack! Harrison has it **99.75** in stock.

### MILLEN 50 WATT TRANSMITTER-EXCITER

Four bands on one crystal. No. 90800, with one set of coils **37.50**

**1N34 CRYSTAL DIODE** Specified in recent articles for noise limiters, field strength meters, etc. **1.00**

## NARROW BAND FREQUENCY MODULATION

WITH YOUR CW TRANSMITTER The Sonar Exciter feeds into the crystal socket of any power rig. Eliminates BC interference! Sensational results! Harrison has it. Complete with tubes. **\$39.45**

### ASK FOR LITERATURE

**MAIL ORDERS?**—Certainly! Just list EVERYTHING you want (items in this ad, or ANY ad, magazine or catalog) and include deposit.

73 de

*Bill Harrison, W2AVA*

# HARRISON HAS IT!

## HARRISON SELECT SURPLUS

Your assurance of good, usable, guaranteed, surplus material at sensationally low prices—**TOP VALUE ALWAYS!** Come in and browse through our large HSS Department!

### BEAM POWER TUBE VALUES

- 807 Always popular! New Amateur net. **\$2.30**
- HSS—\$1.75 each! Three or more at **\$1.47**
- 814 Can give 160 watts output with only 1 1/2 watts drive. Net price \$14.00, reduced from \$17.50. **HSS . . . . . \$7.45**

### 257-B

(4E27) Full power up to 150 Mc! 1.4 watts drives 230 watts output. Amateur net price is **\$24.50** Harrison sells them for **\$6.90** only

### 0-1 DC MILLIAMMETERS

Flush panel mount bakelite case diameter, D'Arsonval movement with jewelled bearings, 2% guaranteed accuracy. FB for multi-meter, field strength, etc. Excellent value at only **\$4.75**

**.0001 MF 9000 VOLT** peak working mica condensers, Sangamo Type PGL, 3/4" x 1/2" body. List price \$29.15. **HSS . . . . . \$6.75**

**2 METER RF CHOKES** Ward-Leonard type Z-O. Dozen (\$55 per Thousand) **\$1.00**

### COAXIAL CABLE!

ALL new, perfect, and at lowest prices!

JAN TYPE	Impedance	O.D.	Price per foot
RG-8/U	52 Ohms	.405"	1-100' up to 9c
RG-11/U	75 Ohms	.405"	10c
RG-13/U	74 Ohms	.420"	14c
RG-39/U	73 Ohms	.312"	11c
RG-58/U	55 Ohms	.195"	8c
RG-22/U	95 Ohms	.405"	25c

TWINAX .405" 25c 25c  
\*Double Shield

Furnished in one piece within —0% to 20% of length ordered. Full measure!

### 240 TUBES

(3C24) An FB tube for VHF, 80 watts rated class B output. Compact size. Ham net was \$9.00, reduced to \$6.00, but Harrison sells them for only **\$1.69** each. Three or more at **\$1.48**

### XYALS

Here is the VALUE in Ham band xials that

BC-406 IS TUBE UHF RECEIVERS Been getting such FB reports from our customers about these swell Signal Corps Radar receivers that we just had to get more for you. Six-acorn tube IF circuit, tuned to 205MC; four IF stages; Thordarson heavy duty power transformer delivering 350 volts at 145 MA; four choke and oil condenser filter; 115 volt, 60 cycle operation; chassis 10 1/2" x 25 1/2" in metal case, slightly used but fully guaranteed. Complete with tubes: 6-954, 1-955, 4-6SK7, 2-6S17, 2-6N7, 1-574. Instructions and diagrams for easy conversion to a hot 10 (also 6 and 2) meter superhet receiver are included. The parts alone are worth much more than our low HSS **\$21.98** Price **PC-406-A** Some, but also has an 11 1/2" x 2 3/4" RPM 110 Volt motor, 1-6N7GT, and 1-6SP5 **\$29.75** (omits 1-6N7). Like new

tops anything you have ever seen! Made for Signal Corps — so they must be good! A fully mounted and sealed crystal for less than the blank alone.

**40 METERS in DC-35 and 80 METERS in DC-34 holders 90¢** (Three or more post-paid.) Specify frequency range when ordering.

### BC-406 IS TUBE UHF RECEIVERS

Have you ever seen anything you have ever seen! Made for Signal Corps — so they must be good! A fully mounted and sealed crystal for less than the blank alone.

44-50 mc, the video carrier would be at 45.25 mc. From the video carrier, the picture side bands extend for 4 mc up to 49.25 mc. The audio carrier would then be at 49.75 mc.

Now suppose the oscillator frequency is 71.00 mc. The mixing of this with the 44-50 mc would produce the following i.f. signals:

1. For the video, the i.f. will range from 21.75 to 25.75 mc. Actually, the i.f.

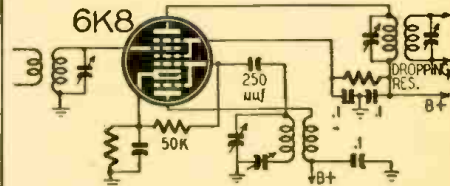
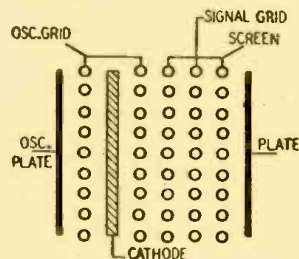

Fig. 7, above—Internal construction of 6K8 converter. Below—Typical 6K8 mixer circuit.

frequencies generated extend to 27 mc. However, the vestigial side band remnants are from 25.75 mc to 27.00 mc and are undesirable. The i.f. bandpass tuning circuits eliminate them.

2. For the sound, the i.f. is centered at 21.25 mc.

The reason for using a higher intermediate frequency for the video voltages arises from the wide band requirements of these signals. The higher the intermediate frequency, the smaller the ratio of

video 4 mc bandwidth

intermediate frequency

and the easier it becomes to design band pass networks possessing sharp end attenuation and higher resistor loading. Consequently the amplifier gain, from the previously noted equation, is higher. It follows, then, that in order to have the video i.f. above the audio i.f. we must place the oscillator above the incoming carriers.

**HAM HEADQUARTERS**  
Since 1925!

**HARRISON RADIO CORPORATION**  
12 WEST BROADWAY • NEW YORK CITY 7  
BARCLAY 7-9854  
JAMAICA BRANCH — 172-31 Hillside Ave. — REPUBLIC 9-4102

## TELEVISION FOR TODAY

(Continued from page 865)

a special "Fine Tuning" adjustment has been converted into a front panel control. Its purpose is to counteract small shifts in the oscillator. Electrically it consists merely of a variable condenser across the oscillator tank circuit. See Fig. 6. In the commercial receiver, Fig. 6, the "Fine Tuning" control is C1.

It is current standard practice to place the oscillator frequency above the sound and video carriers. By being above both signals, the highest intermediate frequency produced will be that of the video signal. To understand why, remember that the audio carrier is 4.5 mc higher in frequency than the video carrier. For a band of frequencies, say

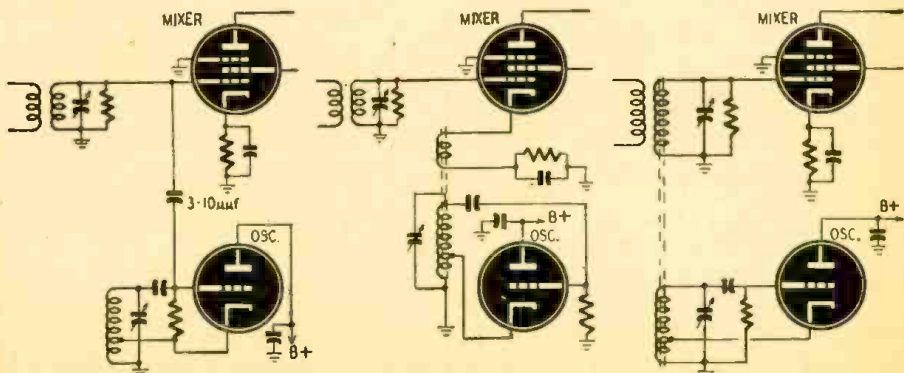
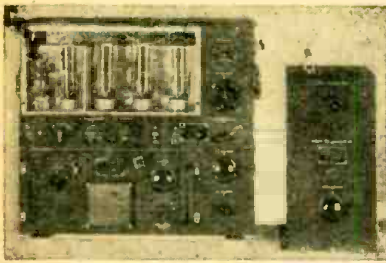
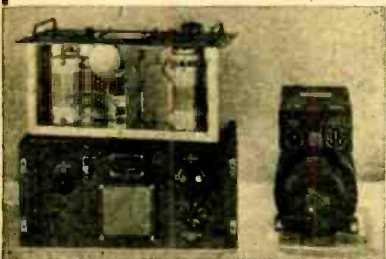

Fig. 8—A number of oscillator-mixer circuits for conversion in v.h.f. superheterodyne sets.



**GENERAL ELECTRIC 150 WATT TRANSMITTER**  
—BRAND NEW! only \$175. This is the famous Liaison transmitter used in U.S. Army bombers and ground stations during the war. Its design and construction have been proved in service under all kinds of conditions, all over the world. The entire frequency range is covered by means of seven plug-in tuning units which are included. Each unit has its own oscillator and power amplifier coils and condensers, and antenna coupling circuits—all designed to operate at top efficiency within its particular range. Transmitter and accessories are finished in black crackle, and the milliammeter, voltmeter, and RF ammeter are mounted on the front panel. Here are the specifications: **FREQUENCY RANGE:** 200-500 Kc. and 1300-12,500 Kc. (will operate on 10 and 20 meter band with slight modification). **OSCILLATOR:** Self-excited, thermal compensated, and hand calibrated. **POWER AMPLIFIER:** Neutralized class C stage, using 211 tube, and equipped with antenna coupling circuits which matches practically any length antenna. **MODULATOR:** Class AB—uses two 211 tubes. **POWER SUPPLY:** Supplied complete with dynamotor which delivers 1000 volts at 350 milliamperes. Complete instructions are furnished to operate set from 110V-AC. **SIZE:** 21 1/2 x 23 x 9 1/2 inches. Total shipping weight, 250 lbs., complete with all tubes, dynamotor, power supply, seven tuning units, antenna tuning unit, and two profusely illustrated instruction books, all in the original factory packing case.



# SENSATIONAL SURPLUS RADIO BARGAINS!

## SCR-284 TRANSMITTER-RECEIVER

Made to be used in Army jeeps and trucks, as well as in the field or as a headquarters set, the SCR-284 is particularly adaptable for all amateur, experimental, marine, aircraft, police, and mobile applications.

The receiver is a 7-tube superheterodyne, featuring an RF stage, four double-tuned 455 KC iron-core IF transformers, 2 audio stages, a beat frequency oscillator for CW reception, and is powerful enough to operate a large size speaker. The transmitter employs a calibrated crystal oscillator, a buffer amplifier, and a pair of RK-75 tubes in the final amplifier stage. The speech amplifier and modulator will operate with any ordinary mike, or for \$2.75, we can include a Signal Corps mike, complete with "press to talk" switch. A built-in antenna tuning circuit, including an RF ammeter, will match the transmitter to any length of antenna. The transmitter diodes are supplied by a 500 volt, 100 MA dynamotor which operates from either a 6 or 12 volt automobile battery. The transmitter output is 25 watts, and operates on both phone and CW. The frequency range is 3760-5825 KC. Operation on other bands may be facilitated by the use of plug-in coils. Circuit diagrams and instructions are furnished.

These sets are specially priced at \$30.95, complete with set of 13 tubes and crystal. The dynamotor, which must be used, if it is not desired to use 110V AC is \$15 additional. Where a compact, and dependable medium power unit is desired, this set is unbeatable!

## 14-TUBE UHF SUPERHETERODYNE RECEIVER — \$39.95

This beautifully constructed receiver was designed especially for Signal Corps communication service, and is one of the finest and most sensitive sets ever manufactured. Operating from 110V 60 cycles, this set has two tuned RF stages, tuned converter and oscillator, five IF stages, using iron-core IF's, a diode detector, tuning eye, and a two stage amplifier that will drive a speaker or phones. The frequency range is 158-210 Mcs. It is a simple matter to operate on other bands by making a slight alteration in the tuning coils. A complete set of tubes is included with each receiver, along with a circuit diagram and parts list. The high-voltage power supply delivers 150 milliamperes, and is well filtered by a heavy-duty choke and three 7 Md. oil-filled condensers. This buy of a lifetime cost the government about \$700. Amateurs and experimenters will never again be able to purchase fine equipment at such a tremendous saving!

**V.M. RECORD CHANGER**—Complete with your choice of either a beautiful blue leatherette cabinet, or a walnut cabinet. This changer is the only medium priced changer on the market that will play both ten and twelve inch records, interchanged, without making any change in adjustments! Beautiful brown finish—chrome and plastic trim. Factory guaranteed, and priced at only \$24.95.

Please remit at least 10% deposit with all C.O.D. orders. Send for our latest radio parts catalog.

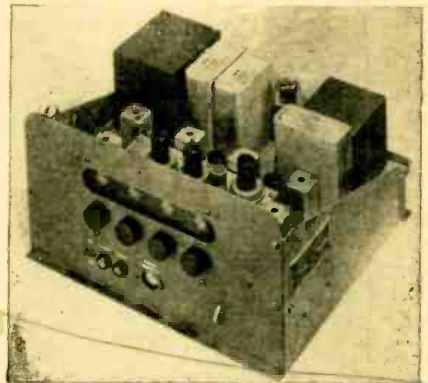
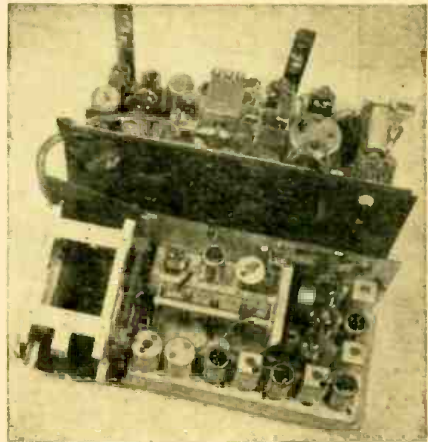

**BUFFALO RADIO SUPPLY 219-221 GENESEE ST., DEPT. C9, BUFFALO 3, N. Y.**

## NEW WESTON TEST EQUIPMENT

in stock—immediate delivery

**Model 785 — Industrial Circuit Tester — 27 Meters in one**—with selected AC and DC voltage, current, and resistance ranges. With DC voltage, sensitivity of 20,000 ohms per volt, it is ideal for testing photo-cell and sensitive relay circuits, alarm systems, electronic equipment, etc., as well as small motors and controls, lighting circuits, etc.

**DC Voltage**—Six Full Scale Ranges of: 1/10/50/200/500/1000 Volts (20,000 Ohms per volt).

**AC Voltage**—Six Full Scale Ranges of: 5/15/30/150/300/750 (1000 Ohms per volt).

**DC Current**—Six Full Scale Ranges of: 50 Microamps—1/10/100 Milliamps—1/10 Amps.

**AC Current**—Four Full Scale Ranges of: .5/1/5/10 Amperes.

**Resistance**—Five Full Scale Ranges of: 3000/30,000/300,000 Ohms—3/30 Megohms.

For Shop Use less carrying case ..... \$ 85.37  
With oak carrying case ..... 101.62

**Model 798—Just Out—Mutual Conductance Tube Checker & Set Analyzer—Tube Checker Ranges 0-3000, 6000, 12,000 Micromhos and Good-Bad Scale.**

**Analyzer Ranges 0-15, 150, 750 Volts AC & DC. 7.5 & 150 M.A. DC. 100,000 & 1,000,000 Ohms ..... \$182.64**

**Model 779 — Supersensitive Analyzer — For Simplified Radio Set Analysis ..... 74.62**

**Model 697—Volt-Ohm Milliammeter ..... 25.89**

## MARITIME SWITCHBOARD

336 CANAL STREET, NEW YORK 13, N. Y.  
WORTH 4-8217

## NEWSPAPER VS. FACSIMILE

Facsimile demonstrations by Finch Facsimile and J. V. L. Hogan last month called forth sober comment from publications of widely differing points of view. More than a suggestion was made that newspapers might find the new system more than a serious competitor.

The advertising magazine *Tide* reported:

"Last fortnight sober thoughts crossed the mind of many a U. S. publisher as he beheld the commercial launching of a new development in radio, what looked like added proof of this innovation's potentialities as a competitor and, eventually, as an adjunct, to newspapers in the U. S."

*The Nation* took a more sober and complicated view of the situation. It reported:

"The technical problems are far simpler than the social and economic ones, for if the development of facsimile broadcasting continues . . . city folks as well as those who live on the farms can be supplied with newspapers and other reading material by radio . . . at the trivial cost of the rolls of paper and the electric current . . . as events take place, as history is made, the facsimile machines will produce directly in the home a contemporaneous printed record. No newspapers will be able to compete."

Apparently facsimile is being taken very seriously in some quarters.

**KWIKHEAT is best**  
**12 ways**  
From Tip-to-Plug in a Class by Itself

**PAST! Hot in Only 90 Seconds**  
**COOL! New Protecting Handle**  
**SAFE! Will Not Overheat**  
**POWERFUL (Full 225 Watts)**  
**SAVES TIME—Less Retinning**  
**BALANCED! Easily Handled**  
**DEPENDABLE—Longer Lasting**  
**LIGHT WEIGHT (Only 13 1/4 oz.)**  
**THREADED TIPS For Best Contact**  
**ECONOMICAL in Operation**  
**THERMOSTAT is Built In**  
**SIX TIP STYLES Interchangeable**

**A KWIKHEAT USER WRITES—**  
"I am certainly convinced that Kwikheats are the best irons that can be obtained. They are really a pleasure to work with."  
H. P. K. Long Branch, N. J.

**225-Watt Iron with #1 Tip \$11<sup>00</sup>**  
Extra Tips—Six Styles, each 1.25

**VANATTA**  
**KWIKHEAT**  
**THERMOSTATIC SOLDERING IRON**  
A Division of  
Sound Equipment Corporation of California  
3903 San Fernando Rd., Glendale 4, California

# HOW TO PASS Commercial Radio Operators' FCC LICENSE EXAMINATIONS...

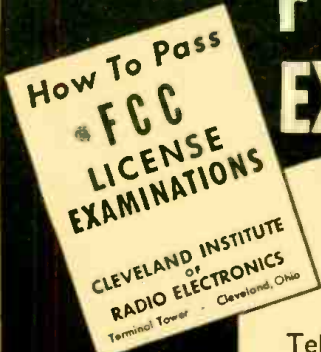

**Don't Delay—  
Write Today!**

## FREE BOOKLET

**Tells you the Government requirements for all classes of commercial operator licenses.**

Tells where to apply for and take the examinations, examining offices, scope of knowledge required, extracts from FCC Rules and Regulations, extracts from FCC Study Guide and Reference Material, approved way to prepare for FCC examinations, positive method of checking your knowledge before taking the examinations.

**Edition Limited—Mail Coupon Before Supply Is Exhausted**

## CLEVELAND INSTITUTE OF RADIO ELECTRONICS

Contractors to the Canadian Broadcasting Corporation

Successors to

NILSON RADIO SCHOOL, Founded 1939

SMITH PRACTICAL RADIO INSTITUTE, Founded 1934

RC-9 TERMINAL TOWER

CLEVELAND 13, OHIO

APPROVED FOR VETERAN TRAINING UNDER G. I. BILL OF RIGHTS

MAIL THIS COUPON

### CLEVELAND INSTITUTE OF RADIO ELECTRONICS

RC-9 TERMINAL TOWER, Cleveland 13, Ohio

Gentlemen: Please send your FREE Booklet, "How To Pass FCC License Examinations."

(Note: This Booklet does not cover examinations for Amateur License)

NAME ..... I have had experience in broadcast-  
 ADDRESS ..... ing  servicing  operating   
 CITY ..... STATE ..... mfg:  CAA  Army-Navy   
 amateur  other .....  
 Check license desired:  
 Radiotelephone  1st. Class  2nd Class I am a  High School Grad. College  
 Radiotelegraph  1st Class  2nd Class Grad.  with degree .....  
 I now hold these licenses ..... If a War Veteran, check here

**THORDARSON TRANSFORMERS**  
 115 V., 50-60 Cy. Primary,  
 6 Volts at 10 Amps. Sec.  
 Leads brought out on an engraved bakelite panel—Wt. 5 lbs. Size 3x3x3 inches. With mounting brackets. Suitable for filament supply, battery chargers, "A" supplies, pin-ball machines, juke boxes, bell-ringers, toys, etc.  
 PRICE ..... Ea. **\$1.50**  
 6 to a carton — no less than 6 sold.  
**AUDIO SALES CO.**  
 9 WARREN ST. NEW YORK 7, N. Y.

100 Watt Vasco Soldering Iron	\$3.30
111 Freq. buzzer, 2 to 4 volts DC	.79
Midget 100 MMFD Variable Condenser	.79
5 Inch PM Speaker	1.77
300 Ohm Amphenol twin lead per 100 ft.	2.90
75 Ohm Amphenol twin lead per 100 ft.	2.00
BC 312 N. or BC 348 Q Army Receivers	59.95

Sales in Calif. add 2 1/2% sales tax  
**DOW RADIO**  
 1759 E. Colorado Pasadena 4, Calif.

**PAPER and MICA CONDENSERS**  
 50 Assorted Paper and Mica Condensers, popular sizes ..... \$1.00  
 Cash, Check, or Money Order  
**PETER BAUER, Dept. C**  
 19 Micieli Place Brooklyn 18, N. Y.

RADIO-CRAFT wants original cartoon ideas and will pay \$3.00 for each one accepted. It is not necessary to send in a sketch unless you so desire. Send in your cartoon ideas today!

## ATOM BOMB OVER BIKINI (Continued from page 824)

er waves—(water, that is!) An automatic clock started the recorders connected with the sounders half an hour before the bomb was scheduled to go off.

Certain other recently-developed and still secret electronic devices were used to record wave height versus time at remote parts of the lagoon and at other atolls such as Eniwetok, Kwajalein, Wotho, and Rongerlap. Two radio repeating wave buoys planted two and four miles from the point of the explosion radioed the wave heights to one of the photographic planes.

Ten simple maximum-water-height indicators were mounted near the water's edge. Each unit consists of a pipe, a contactor strip, and a dry cell. It is equipped with a set of fuses which blow as water passes up the pipe and creates a short-circuit.

### RADIO CAMERA CONTROL

The wave measurement group relied heavily on photography for measurable data. It used simultaneous air-ground photographs, stereo-pairs of ground camera and television photos, and right-angle pairs of ground photos. The first test was expected to provide a full-scale test of such matters as shielding of cameras and radios. The analysis of photographs for measuring scientific data (called photogrammetry) depends for its success on stop-watch timing effected by radio controlling links. These radio links consist of transmitters in one of the aircraft. As each control pulse is received, each camera makes one exposure and cycles forward ready for the next pulse.

Two television transmitters were located on towers 2000 feet apart on Bikini and aimed at the target area. Receivers set to the transmitter's frequency were aboard the two photo planes. Special motion picture cameras were focussed on these receiver screens to record the television images permanently. Supplementary receivers set to the same frequency were on the flagship Mt. McKinley and also on the Appalachian.

The seismology group of the oceanographic section was concerned not only with the measurement of the amplitude and character of the earth's vibrations resulting from the bomb, but also hoped to gain some information on the sub-surface structure of the atoll by refraction and reflection measurements similar to those used in electronic geophysical prospecting. According to the best available data, the seismographs recorded absolutely nothing. No announcement has been made as to the information gained on sub-surface structure.

The oceanographic work was carried on by means of current meters similar to anemometers; by means of current poles weighted at the bottom and

(Continued on page 874)



**TRANSATLANTIC NEWS**  
(Continued from page 841)

use carriers with frequencies separated by 35 kc. Both carriers lie within the band width of the r.f. and i.f. stages of the receivers (Fig. 1) without producing audible interaction. The two transmitters, eleven miles apart, used frequencies of 80.0175 and 79.9825 mc—see Fig. 2. A central control station supplied modulation to both by radio links. The first difficulty encountered was interference from auto ignition systems and this led to the development of a noise-limiter so effective that freedom from all types of interference is stated to be as complete as with FM.

Tests showed excellent results. No distortion could be detected in the area covered and in towns and valleys the flutter associated with single-carrier v.h.f. transmissions was hardly noticeable. Both carriers do actually flutter, but not as a rule at the same time. The receiver selects the signal that is the better at any instant and the change-over from one carrier to the other is imperceptible. Throughout the area, signal strength was found to be much greater than with a one-station system. "Diversity transmission" had proved itself to be as effective as diversity reception and the next step was to use it on a much larger scale. This is illustrated diagrammatically in Fig 3.

Taking the outward paths first, the 7-watt transmissions on 81.30 mc from Police hq. are picked up by a receiver at the main transmitting station which triggers off a 30-watt transmitter working on 130.80 mc. Its signals go to receivers at all three stations where they trigger off 100-watt transmitters working on 96.32 mc (main station), 96.28 mc (slave A) and 96.30 mc (slave B). A 130.60 mc receiver is used at the master station as well as at the slaves in order to equalize the path and to ensure as far as possible that the three 100-watt transmitters are modulated in the same phase.

Receivers in police autos receive all three signals and the results are remarkable. Signal strength is constant over practically the whole wide area covered, even in the deep, narrow valleys, and there are no areas of distortion corresponding to those of no-capture with FM. The frequencies used show surprising penetration of streets, tunnels and even steel-frame buildings. A slight heterodyne whistle is at times to be heard if the 96.28, 96.30 and 96.32 mc carriers are not precisely evenly spaced. This is easily corrected and in any event the whistle is so faint (30-40 db below signal level) that it causes no interference with communication.

On these very high frequencies AM, perhaps rather surprisingly, shows up well in comparison with FM. Natural static is virtually unknown and interference from trams, trolley buses and machinery is very light at 75-82 mc, less still at 95.5-100 mc and almost entirely absent on 128-131 mc. With the special noise-limiter devised AM is as good as

**THE SECRET'S OUT!**  
*The New and Spectacular*  
**ACA-100DC AMPLIFIER**  
*Is Ready For Delivery!*

DESIGNED BY A. C. SHANEY



A revolutionary development in amplifiers cleverly designed to defy obsolescence and amazing in its performance. New circuits, new materials and new processes are actually combined in this one amplifier to produce the most satisfying musical amplifier the world has ever known. If you are one of those discriminating persons for whom nothing less than the best is a disappointment, you are one for whom the ACA-100DC was designed. Send for technical literature.

**AMPLIFIER CORP. of AMERICA**

398 Broadway, New York 13, N. Y.

A. C. Shaney's FM-AM AMPLIFIER MANUAL is still available at 25c

**MORE SMASH BUYS at National Radio Distributors**

**IMMEDIATE DELIVERY**



5 Tube AC/DC Superheterodyne Radio Kit using 128A7, 12BK7, 12SQ7, 50L6 and 3Z5 tubes. Features built-in loop antenna, automatic volume control, new Alnico speaker. Complete with all necessary parts and full instructions for assembling and including high polish brown streamline cabinet. Approx. size 9 x 6 x 5. Your Net less tubes .....\$13.75 each  
Your Net less tubes for lots of 3 .....\$12.95 each  
Kit of 5 matched tubes for above .....\$4.95



New Post-War 2 Post Record Changer with beautiful leatherette covered case. Will take 10-12" or 12-10" records. Extra heavy duty construction assures long trouble-free life. Stops automatically after last record is played. Approximate size of complete unit 16 x 14 1/2 x 10. SPECIAL .....\$24.95

**SPECIAL BUYS**

3 Tube AC/DC Phono Amplifiers featuring tone and volume controls. Complete, ready to operate. Approximate size 5 x 3 1/2 x 1 1/4. Uses 50L6, 3Z5 and 12SQ7 tubes.

Your Net less tubes .....\$4.25 each  
Your Net less tubes in lots of 3 .....\$3.95 each  
Kit of 3 matched tubes for above .....\$2.95

Tubular Type By-Pass Condensers. All 600V. fresh stock and fully guaranteed. All sizes available.

.001 to .005 Mfd.	Per 10 \$ 7.70	Per 100 \$ 5.50
.01 to .05 Mfd.	Per 10 \$ 8.80	Per 100 \$ 6.50
.1 Mfd.	Per 10 \$ 9.90	Per 100 \$ 8.00

Kit of 100 assorted sizes, all 600V. up to and including .1 Mfd. ....\$5.95

Tubular Type Electrolytic Filter Condensers fully guaranteed 1 year, with mounting bracket. All fresh stock.

20x20 Mfd. 200V	Per 10 \$ 3.50	Per 100 \$ 32.50
Rx8 Mfd. 450V	Per 10 \$ 6.00	Per 100 \$ 57.50
25 Mfd. 35V	Per 10 \$ 2.10	Per 100 \$ 19.50
10 Mfd. 25V	Per 10 \$ 1.95	Per 100 \$ 17.50

Deposit must accompany all C.O.D. orders.  
Write NOW for FREE catalog.

**National Radio Distributors**

1029 E. 163 St., New York 59, N. Y.

FM in the matter of auto ignition interference—the only serious type experienced. One great advantage of AM is the simpler and cheaper nature of the equipment required. It may be that some means of eliminating the area of no-capture with two-carrier FM will be found. Until this is done it seems that for the coverage of police and similar areas and the maintenance throughout them of steady signal strength, v.h.f. diversity AM is the better method.

*it's* **"RADIONIC"**  
**FOR EVERYTHING ELECTRONIC**

**REINER MODEL 333 MASTER TESTER**

One unit can serve 20 or more different single instruments. To operate, you need merely insert the proper shunt or multiplier for the range desired and you're ready to take readings. D.C. ranges only. Supplied complete with 6 shunts, 6 multipliers, 2 meter fuses and instructions. Net. ...\$27.05



Write for complete REINER catalog

**RADIO BOOKS FOR BEGINNERS!**

10 books covering radio building, theory, aerials, dictionary of radio terms, learning to read diagrams, electrical experiments, television, etc. Written in simple, non-technical language. All 10 books only.....postpaid

**75c**

(Clip coupon on your letterhead or penny postcard)

**FREE CATALOG!**

R.E. Co. Dept. RC9—Please send me a copy of your free catalog of parts, accessories, tubes, public address, communicating equipment, test equipment, amateur equipment, radios, photo players, etc.

Name .....  
Address .....  
City ..... State .....

**RADIONIC Equipment Co.**

"Chancellor Products"

170 NASSAU ST. · NEW YORK 7, N. Y.  
WOrth 2-0421 Cable: CHANSLOR

**THE POSTWAR RADIOS**

(Continued from page 836)

case, the last zero has been omitted from the dial scale so that 90 on the dial indicates the correct dial setting for receiving a 900-ke station. With the 1-inch direct tuning knob, it is somewhat difficult to tune in a high frequency broadcast station "on the nose."

# LEEDS CONDENSER VALUES

## GUDEMAN OIL FILLED

0.5 MFD	1500 v.	\$ .50
0.25 MFD	2000 v.	.50
2x.23 MFD	1200 v.	.35
4 MFD	500 v.	.50

## AEROVOX OIL FILLED

1 MFD	600 v.	.25
1 MFD	1000 v.	.35
2 MFD	1000 v.	.95
8 MFD	1500 v.	3.75
2 MFD	2500 v.	3.50
0.1 MFD	7500 v.	1.50

## CORNELL DUBILIER OILS

2x0.25 MFD	600 v. type DYR	.25
2x0.1 MFD	600 v. type DYR	.25
2 MFD	600 v.	.75
4 MFD	4000 v.	8.00
6 MFD	4000 v.	10.50

## G. E. PYRANOLS

4 MFD	600 v.	.95
7.5 MFD	330 v. AC	1.25
10 MFD	600 v.	1.50
10 MFD	1000 v.	2.25
10 MFD	1500 v.	3.50
8 MFD	2000 v.	5.00

## SOLAR

1 MFD	5000 v.	5.00
-------	---------	------

## METERS

W.E. 3" Bakelite case		
100-0-100 microamps		4.75
50-0-50 milli amps		3.50

## WESTON 506

0-1 MA	500 v. scale	3.50
--------	--------------	------

## TRIPLETT 221

Rectifier type DB meter		3.00
GRUEN 0-3 MA Bakelite case		1.95
has milliamp volt scale		
6E 27v. 54 watt heating elements		.10

## A FEW LEFT—WHILE THEY LAST

BC 412 Scopes, 110v. AC operation		
Complete with tubes		35.00

## BC 221 Freq METER

Complete with crystal, tubes		
and calibration book		54.50

## FOR YOUR FREQ-METER

Blank calibration book, spec.		2.00
-------------------------------	--	------

A deposit of 25% must accompany all orders.  
All prices F.O.B. our warehouse New York.

No order under \$2.00  
We ship to any part of the globe

# LEEDS RADIO CO.

75 Vesey St., Dept. 45  
Cortland 7-2612 New York City 7

## ATOM BOMB OVER BIKINI

(Continued from page 872)

equipped with yellow pennants, radar targets and lights; dye bombs which diffuse dye at a constant rate through the water; and various devices to measure oxygen, salinity, temperature, diffusivity, and other variables.

A pre-bomb survey of the lagoon was made by one of the scientists who donned a Navy shallow water diving suit equipped with special underwater writing materials—(probably the first recorded use of those pens we've heard so much about!)

Operation Crossroads is undoubtedly the first military organization ever to have a "radiological safety officer." This has a sinister sound and radiological hazards are sinister. The normal channels of your five senses give no warning of the danger since radioactivity can neither be seen, heard, smelled, felt, nor tasted. When you do become aware of it, physical degeneration has already started. You can then do nothing but wait for the end.

The majority of the dangers caused by the bomb itself are of extremely short duration and occur within a range of 7000 yards. Danger from blast, heat, and radiation was avoided by requiring both ships and aircraft to be at least ten miles away at the time of detonation. Damage to the eyes of observers was prevented by the use of high-neutral-density goggles. Persons without goggles were warned not to look directly at the blast, to turn away, or to shield their eyes with their arms. After the first flash, they were permitted to view the rising incandescent column with the naked eye. One sailor who ignored these warnings and attempted to view the explosion without goggles was removed from the ship, temporarily blinded. He was probably the first American casualty of atomic bombs.

Of the two remaining primary hazards, radiation and radioactivity, the latter presented the more serious problem. Radiation occurs at the time of detonation only, and consists primarily of free neutrons and gamma rays. Within a certain range, human or animal life is destroyed by radiation through its attack on blood-forming cells, the initiation of serious internal hemorrhages, and through burns or the slow oozing of the blood into the flesh. Since radiation is localized, personnel was completely protected against it by the distance from the detonation.

This is not true of the radiological hazard, which is the emanation of alpha particles and beta and gamma rays from minute fragments of the bomb and surrounding matter. Among the elements in sea water, sodium, chlorine, iodine, bromine, and potassium all become radioactive with different half-life periods running from a few seconds to many hours.

The degree of radioactive hazard was measured by Geiger-Mueller counters

(Continued on page 876)

## Sigmon's - WEST VIRGINIA'S LARGEST RADIO SUPPLY HOUSE!

\* ALL STANDARD LINES CARRIED IN STOCK

## AMPLIFIER for GUITAR or PHONO



- \* TUBES, 6S5J, 6J5, 6L6, 5V4G
- \* 4 Tubes—Hi Gain
- \* Two Microphone or Instrument Inputs
- \* Phono Input
- \* 6 1/2 Watts—Beam power
- \* Solid Wood Cabinet
- \* Aeroplane Cloth Covered
- \* Tone Control
- \* Heavy Duty 8" Speaker
- \* Complete with Tubes

Complete With Tubes—List \$59.50 **YOUR COST \$37.00**

VMI BRUSH CONTROL MIKE—Net \$10.40  
MM TURNER CONTACT MIKE—Net \$ 9.45

## Phono Amplifier



3 Tube AC-DC  
Uses: 50L6, 35Z5, 12SR7,  
and 450 ohm speaker  
Net \$5.97

FOR LATEST CATALOG WRITE TO..

# Sigmon's

RADIO  
SUPPLY

CHARLESTON, W. VA.

## 18 YEARS IN RADIO



## GET THIS New CATALOG By This Old Firm

Latest developments in radio and electronic parts and devices, newest ham gear, gadgets for experimenters, bargains in war surplus items,

## FREE TO YOU

Mail the coupon below and get this new catalog FREE.

----- BA -----

BURSTEIN-APPLEBEE CO.,  
1012 McGee, Kansas City 6, Mo.  
Send me FREE catalog advertised in  
Radio Craft

I AM \_\_\_\_\_  
STATE CONNECTION IN INDUSTRY \_\_\_\_\_

NAME \_\_\_\_\_

ADDRESS \_\_\_\_\_

TOWN \_\_\_\_\_ STATE \_\_\_\_\_

famous for

# GREAT VALUES

## Outstanding Offerings Of NEW KITS!

**6 Tube SUPERHET KIT** — Two band complete with tubes and solid color (green, red, ivory, etc.) wood cabinet. Includes all parts, except wire and solder ..... **\$18.50**  
Per Kit

**PHONO KIT** Consists of AC Phono-Motor, Pick up, all parts necessary for 3 tube phono Amplifier, including 5" P.M. speaker. Excludes wire, solder and tubes ..... **\$16.25**

With the Above { PA-12 portable leatherette-covered all-wood cabinet ..... **\$7.95**  
Kit of tubes ..... **\$1.85**

All prices are F.O.B. New York City.

Write for our new catalogue showing new test equipment, tubes and a large variety of new replacement parts. We ship anywhere in the U.S.A.—promptly.

## RADIO DEALERS SUPPLY COMPANY

135 LIBERTY ST., NEW YORK 6, N.Y.

## MANUSCRIPTS WANTED

25,000 - 35,000  
words

In clear, semi-technical language on various radio subjects. For Radio-Craft's new 50c book series.

Payment on acceptance  
plus royalty.

For details, write

Box S

RADIO-CRAFT

25 West Broadway, N. Y. 7, N. Y.

## ★ SPECIAL VALUES! —HURRY—QUANTITIES LIMITED—

5" 1000 ohm dynamic speakers ..... \$1.90  
5" P.M. speakers, alnico 5 magnet ..... 1.70  
Boxed antenna kits ..... .74  
Loop antennas ..... .38  
Lightweight crystal pick-ups ..... 2.75

**POCKET-SIZE VOLT-OHM-MILLIAMMETER**  
0-1500 volts AC-DC; 0-150 M.A.; 0-300,000 ohms. SPECIAL! ..... \$16.95

8" Walnut speaker baffles ..... 2.85  
12" Walnut speaker baffles ..... 4.80  
Air-Raider All-Wave Noise-Reducing antenna kit, with matched coupler ..... 5.58  
Also, TUBES • TEST INSTRUMENTS • AMPLIFIERS

25% deposit with order, balance C.O.D.  
**SCENIC RADIO & ELECTRONICS CO.**  
53 Park Place • Dept R • New York 7, N. Y.

## LINK-COUPLED CRYSTAL SET

(Continued from page 831)

insert L2 inside of L1, about ¼-inch from the ground end of the coil.

Insert L3 inside of L4 in a like manner. The entire set of windings of L2 and L3 should be used as a starter, and should not be changed unless necessary. Place SW1 (on L1) on the next to the last tap away from the ground end. Place SW2 on the next tap nearest SW1 but toward the ground end. Place SW3, on L4, on a tap to include about three quarters of the length of the coil. (NOTE: While L1 and L4 are exactly alike in physical dimensions the corresponding switches will not necessarily read the same, because the two units are separate and are performing two different functions). SW1 is changed only when a shift is made from one extreme of the set's tuning range to the other. The position of SW2 should normally be between SW1 and ground.

Using your right hand for main tuning and your left for antenna tuning, the main tuning dial, C2, is slowly swung across its arc. If a station is heard, the antenna tuning dial, C1, should be shifted until the signal increases in strength. Unless this occurs the set is not functioning properly. Try a different setting of taps, or move the pickup-coils (on link line) to the extreme ends of their big brothers.

The best way to search out the elusive dx is to get the set fired up as well as possible on a nearby signal; then move L2 and L3 OUT slightly from their big brothers in order to increase the selectivity, moving both the tuning dials AWAY from the local. Once you hear a dx station you should try everything in the books to bring its signal strength up. Increase the coupling between circuits, try different taps, and rotate the main dials individually until you have the station centered. The main object is to drag the dx out into the open while shoving the locals into a hole. The author can tune across the band and pick out dx at will, as long as it's coming through at all. Have a little patience, keep a log, and you, too, can pull in the dx like nobody's business!

Parts list for the Two Timer: C1 and C2: 365, 450 or 500 µf. DO NOT "GANG" . . . use separately! L1, L2, L3, and L4: See text. Phones: Any good high impedance type. Crystal detector: Any popular mineral detector. SW1, SW2 and SW3: See text. NOTE: No phone condenser is used.

An oceanic layer which reflects sonar waves has been discovered in the Pacific. The layer is between 1,000 and 1,500 feet below the surface, rising at night and sinking in the daytime. Scientists believe it may contain suspended matter which reflects back the echoes heard by the sounding apparatus.

FOR IMMEDIATE DELIVERY!

# WATERMAN POCKETSCOPE!



MODEL  
S-10-A

Small, compact, lightweight! Full vision in any position. It's a complete cathode ray oscilloscope capable of indicating in vertical and horizontal dimensions. Weighs only 5¼ lbs. Precision built, fully accurate.

**\$55**

## SHALLCROSS D-C BRIDGES



No. 630 — WHEATSTONE BRIDGE

Measures resistance from 1 to 11.1 megohms. Accuracy 1%. Built-in galvanometer, sensitivity of 1 micro-ampere, per millimeter division.

**\$75**

Write for detailed bulletins on Waterman PocketScope and complete Shallcross line. Get our bargain flyer with many money-saving radio needs listed.

# Radio Electric

SERVICE CO. OF PENNA., INC.  
7TH AND ARCH STREETS, PHILA. 6, PENNA.  
Branches in Wilmington, Del., Easton, Penna., Allentown, Penna.

# Highest Quality RADIO and ELECTRONIC Testing Equipment

IMMEDIATE DELIVERY FROM STOCK GUARANTEED

## Weston Ohmmeter

Model 689-IF  
List Price \$25.50

Our Price: \$14.85

This Ohmmeter has a double range of 0-10 and 0-1000 ohms for the accurate measurement of low resistance values. This type is widely used for production testing armature and field resistances of small motors, relay and coil testing, transform, winding tests and other similar appliances. Complete with operating instructions, test leads and leather carrying case.



## The New Model S-10-A

Pocket Size Oscilloscope

Net Price: \$55.00

Complete cathode ray oscilloscope incorporating the cathode ray tube, vertical and horizontal amplifiers, linear time base oscillator, synchronization means and self-contained power supply. Complete with tubes and operating instructions.



## The New Model 543-S

SUPREME MULTIMETER

Net Price: \$24.75

1% WIRE WOUND PRECISION RESISTORS. Ranges at 1000 ohms per volt standard

sensitivity. Full size 3" square meter with a rugged, accurate 200 microampere movement and a knife edged pointer. All ohmmeter ranges, including the megohm range are operated by batteries and contained within its durable black molded bakelite case.



## The New Model 274

Dumont Five-Inch Oscilloscope

Net Price: \$99.50

Input Impedance: Y Axis: Direct 5 meg., 60 µf. X Axis: Direct 5 meg., 80 µf. Z Axis: 10 rms. volts to blank. Y

Amplifier: 1 meg., 70 µf. X Amplifier: 5 meg., 30 µf. Sine wave response uniform within 20% from 20 cycles to 50 KC. Continuously variable frequency range from 8 c.p.s. to 30 KC. Synchronizing signal sources: internal or external.



## McMurdo Silver Model 904 Capacitance Resistance Bridge

Net Price \$49.90

$\frac{1}{2}$  mmfd/ohm thru 1,000 mfd./megohms; 0-50% power factor; 0-500 volt adjustable internal polarizing voltage; 0-10 and 0-100 ma. electron-ray leakage current meter; measures resistance, capacitance under actual operating voltages!



## The New Model 705 Signal Generator

Net Price \$49.50

RANGES: From 95 kc to 100 mc, continuously variable. Calibration accurate to 2% through broadcast bands, within 3% for high frequency bands. Planetary drive condenser, direct reading calibration, output modulated or unmodulated. Self-contained electronic modulation 400c sine wave available for external use. Special feature provided in having two degrees of modulation at both approx. 30% and 80%.



## McMurdo Silver Model 905 "SPARX" Dynamic Signal Tracer

Net Price \$39.90

Frequency range from 20 cycles to over 200 megacycles. Contains isolating capacitor, resistor and one of the new radar u.h.f. crystal diodes. Leads a circuit being tested with only 3 mmfd. and higher than .5 megohm.



## The New Model 802N Combination TUBE & SET TESTER

Net Price \$59.50

D.C. Voltmeter: 0/10/50/500/1000 at 1000 ohms per volt. Four Range A.C. Voltmeter: 0/10/50/500/1000. D.C. Milliammeter: 0/1/10/1000 DC Ammeter 0/10. DB Meter: -8/15/15 to 29/29/10 to 49/29 to 55 decibels. Four Range Output Meter—same as AC Volts.

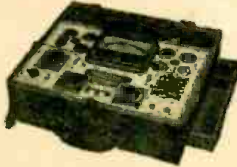

McMurdo Silver Model "Vomax" Vacuum Tube Voltmeter	59.85
SUPREME Model 589 Tube & Battery Tester	48.95
SUPREME Model 599 Tube and Set Tester	\$ 62.50
SUPREME Model 568 Vacuum Tube Voltmeter	83.50
SUPREME Model 546 Oscilloscope	89.75
R.C.P. Model 448 Pocket Multitester	24.50
R.C.P. Model 423A Volt-Ohm-Milliammeter	29.50
R.C.P. Model 322 Tube Tester	41.50
R.C.P. Model 461 AP Sensitive Multitester	43.50
R.C.P. Model 664 Electronic Multimeter	45.00
R.C.P. Model 322P Tube Tester (Portable)	45.50
R.C.P. Model 315 Tube Tester	59.50
R.C.P. Model 488A Ultra-Sensitive Multitester	71.50
R.C.P. Model 668 Vacuum Tube Volt-Ohm-Capacity Meter	74.50
R.C.P. Model 665 A V. T. Volt Ohmmeter insulation tester	94.50
Reiner Model 333 Master Tester	27.50
Reiner Model 530 Squarewave Generator	95.00

Reiner Model 451 Vacuum Tube Volt-Ohm-Milliammeter	150.00
Superior Model CA-11 Signal Tracer	18.75
Superior Model 1553 Volt Ohm Milliammeter	24.75
Superior Model 680 5000 Ohms Per Volt V.O. Milliammeter	27.65
Superior Model 670 Super-Meter	28.40
Superior Model PB-100 Volt Ohm Milliammeter	28.40
Superior Model 450 Tube Tester	39.50
Superior Model 650 Signal Generator	48.75
Superior Model 720 Multi Range AC Ammeter	49.50
Superior Model 600 Combination Tube and Set Tester	62.50
SHALLCROSS Decade Resistance Boxes	13.50
SHALLCROSS Portable Galvanometers	27.50
SHALLCROSS Model 630 Wheatstone Bridge	75.00
SHALLCROSS Model 637 Kelvin Wheatstone Bridge	100.00
RECORD CHANGER Model VH-200	22.50
RECORD CHANGER Model MAGuire	24.50

Write for our FREE New POST-WAR CATALOGUE!

# Metropolitan

ELECTRONIC & INSTRUMENT CO.

Dept. C, 6 MURRAY STREET  
NEW YORK 7, N. Y., U. S. A.

Cable Address: METRONICS  
Phone: BArlay 7-5556

## ATOM BOMB OVER BIKINI

(Continued from page 874)

and by strips of photographic film placed on board ships and carried by personnel. These film strips were periodically replaced and those that were carried by personnel were checked for radioactivity, which affects film the same way as light does. The Geiger counter consists primarily of a special gas-filled tube with two electrodes connected to a battery. Any radioactive particle entering this tube ionizes the gas and a small electrical impulse is thereby permitted to pass through the tube. This is amplified to a point where it can be indicated either by a dial or by audible "ticks." Counters may be made extremely sensitive or they may be made to operate under conditions of intense radioactivity, in every case serving to measure the intensity.

With these safety precautions carefully observed, no one should have received any injuries from radioactivity. Fifty medical officers underwent an intensive three-months training course which included a flight over the original atomic bomb test site in New Mexico. Their Geiger counters picked up "ticks" indicating a small amount of continued radioactivity from last July!

## ROBOT PLANES IN ACTION

Radio-controlled drones were used to great advantage in this test. Four "Mother" or control planes controlled four "Babes" or drones. A "Super-mother" or master control plane was rigged so that it could take over the flight of any drone that failed to respond to the signals from its mother. These hovered over the observing ships until the bombing plane made its final run over the target. The instant that the bomb dropped, a lethal cloud of extremely dangerous radioactivity rose, reaching 60,000 feet in about six to ten minutes after the detonation. This was predicted, expected, and prepared for. From what we on the Appalachian saw, the cloud appeared to be about sixteen miles in diameter.

The Babes were impelled toward the cloud by the watchful Mother planes which remained at a safe distance. (In this case, the Mother planes acted contrary to the instincts of a true mother, by sending their Babes into danger while the Mother remained behind to watch the results.) Each plane was to enter the cloud at a different altitude and was to maintain this altitude while in the cloud and upon emergence. An amusing sidelight of this phase was the action of one particularly stubborn little drone that disobeyed the frantic signals from both the Mother and the Super-mother. Nothing seemed to have any effect on this independent drone and a hurried conference was held to decide whether or not to shoot it down. The control crew decided that since the drone had a limited gas supply, it would end up in a watery grave anyway, and so it was permitted to continue its merry way on the course it had set for itself—in the general direction of China!

## AUDIO RESPONSE CORRECTION

(Continued from page 827)

### RESISTANCE-CAPACITY CIRCUITS

Two main types of circuits are employed, those that give a bass boost by attenuating all the higher frequencies to a reduced but finite value and those that reduce the highs, approaching zero response as the frequency increases.

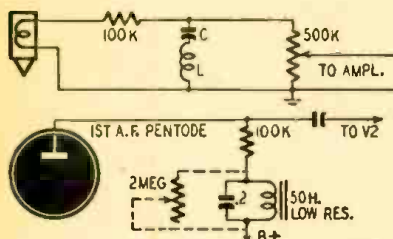

Fig. 6—Tuned acceptor and rejector filters.

The first type can be designed to give a "boost" of any desired rate over any frequency range, but the amounts of boost cannot approach infinity as the loss at high frequencies due to the filter is at least equal to the bass boost produced at very low frequencies. If the pickup has a very low bass resonant frequency, say around 20 cycles, full compensation is needed and the filter must provide a boost of around 6 db per octave. On the other hand, if the pickup head is fairly light and the needle very stiff and difficult to deflect, the bass resonant frequency will be well inside the audible region and little compensation is required. Circuits for both these conditions are shown in Fig. 4.

Now what about the high-frequency end of the spectrum? This end is *never* attenuated in recording and is usually boosted, so the problem is how to attenuate the highs to a reasonable value. If the high boost is progressive, (increasing with frequency) a simple one-section filter such as is shown in Fig. 5-a may meet the case. The resistance may be the plate resistance of the first tube in the amplifier—in which case only the condenser is used—or the filter as shown may be connected directly after a high-impedance magnetic pickup. Sometimes when the pickup is a really good one with a high needle resonance frequency, a multi-section filter may be used to give a sharp cut-off just below the unwanted resonance. The circuit of such a filter is shown in Fig. 5-b, the constants being suitable for a 500-ohm or medium impedance job.

It is very rarely that a boost is required in reproducing the upper highs around 5,000 cycles, but if required, the circuits of Fig. 4 may be used with the series resistor bridged by a small capacity such as a .002 microfarad condenser.

### TUNED FILTERS

An "acceptor" or series L-C circuit may be shunted across the output of a pickup or the output of the first tube to absorb energy at some undesired

frequency (usually the top resonant frequency) but such circuits are *usually* failures for several reasons.

The designer may omit to take into account the inductance and capacity of the pickup; the filter has too low a "Q" factor (absorbs too little energy at the undesired frequency and too much at neighboring frequencies) the inductance may be large and bulky and may have hum voltages induced in it. Generally the inductance should be very large and the capacity small—a filter composed of a few r.f. chokes and .006  $\mu$ f condensers is not very helpful and gives a more or less general high-frequency cut. In an ideal system the frequency of the acceptor circuit should be variable because the resonant frequencies of the pickup vary with type of needle and wear of needle as well as with hardness and groove contour of the record.

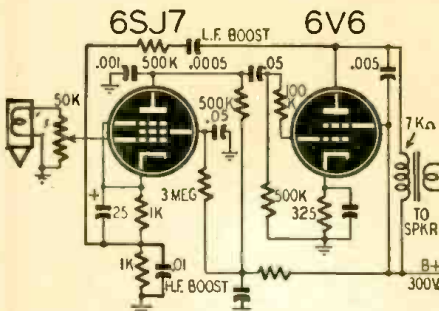

Fig. 7—This circuit uses negative feedback.

Rejector or parallel L-C circuits may be inserted in the load of the first tube to provide a boost around some frequency, usually in the bass, to compensate for attenuation in recording. Again there is the problem of hum pickup. Besides, the introduction of a resonant circuit means that some notes are prolonged.

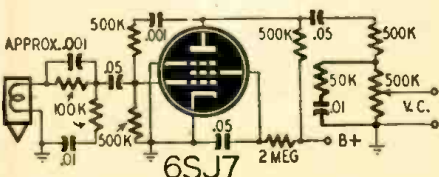

Fig. 8—Negative feedback direct to pickup.

Care must be taken to see that the natural frequency of the L-C circuit is not at or adjacent to the diaphragm resonance of the loudspeaker or the bass resonant frequency of the pickup. The frequency may be changed by trial and error by shunting capacities across the inductance. These bass-boost tuned circuits are usually easier for the amateur to get going than the acceptor "scratch-filter" circuits. To provide a variable control of the bass accentuation a 2-megohm potentiometer may be connected in parallel with the inductance and condenser.

If the tube preceding the tuned cir-

## FOR ALL *Electricians*



**PRACTICAL ELECTRICITY** at your finger ends. Answering your Questions and giving the facts and figures of your trade. Audel's Electrical Guides contain Practical Inside Trade Information in a handy form. Fully illustrated and Easy to Understand. Highly Endorsed. Check the books you want for 7 days' Free Examination. Send No Money. Nothing to pay postman. If satisfied pay only \$1 a month until purchase price is paid.

ASK TO SEE THEM.



Get This Information for Yourself. Mail coupon today. No obligation unless O. K.

## --- CUT HERE --- MAIL ORDER

**AUDEL, Publishers, 49 W. 23 St., NEW YORK 10, N. Y.**  
Please send me postpaid for FREE EXAMINATION books marked (x) below, if I decide to keep them I agree to mail \$1 in 7 Days on each book ordered and further mail \$3 monthly on each book until I have paid price.

- ELECTRICIANS EXAMINATIONS, 250 Pages . . . \$1.
- WIRING DIAGRAMS, 210 Pages . . . . . 1.
- ELECTRICAL DICTIONARY, 9000 Terms . . . . . 2.
- ELECTRICAL POWER CALCULATIONS, 425 Pages. 2.
- HANDY BOOK OF ELECTRICITY, 1340 Pages . . . 4.
- RADIOMAN'S GUIDE, 914 Pages . . . . . 4.
- ELECTRONIC DEVICES, 216 Pages . . . . . 2.
- ELECTRIC WELDING, 400 Pages . . . . . 1.
- ELECTRIC LIBRARY, 12 vol., 7000 Pgs., \$1.50 Each

Name \_\_\_\_\_  
Address \_\_\_\_\_  
Occupation \_\_\_\_\_  
Employed by \_\_\_\_\_ RCP

## SPECIAL

New Astatic Low Pressure Crystal Pickups L72A 3.5V. Output Special \$2.97 ea.  
New Astatic Low Pressure LP6 Permanent Sapphire Stylus Pickups Special \$3.99 ea.  
New Shure Glider Curved Arm Featherweight Pickups Special \$2.88 ea.

**American Parts, Inc.**  
610 W. RANDOLPH STREET  
CHICAGO 6, ILL.

## WIRELESS PHONO OSCILLATOR

NO LICENSE REQUIRED

Transmits recordings from phono pickup or voice from mike to radio without use of wires up to 500 ft.  
Complete Kit with tubes . . . . . \$5.75  
Above Kit assembled and tested . . . . . \$6.95  
Immediate delivery. Write for details and information.

**CONSTANT ELECTRIC**  
112 Cornelia Street Brooklyn 21, N. Y.

# SPEED UP REPAIRS WITH THESE G-C AIDS!

## G-C is HEADQUARTERS for RADIO PARTS and SERVICE AIDS



All Types of Radio Cements, Chemicals, Coil Dopes, Compounds

G-C leads the field in supplying Radio - Electronic Manufacturers and Service Men with Parts, Tools, Radio Cements, Chemicals and Compounds. Insist on Genuine G-C Quality.

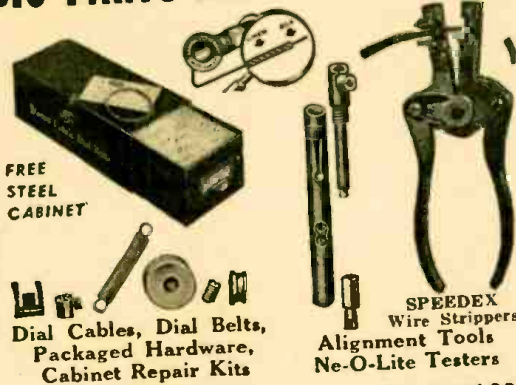

FREE STEEL CABINET

Dial Cables, Dial Belts, Packaged Hardware, Cabinet Repair Kits

SPEEDEX Wire Strippers Alignment Tools Ne-O-Lite Testers

ORDER FROM YOUR JOBBER—SEND FOR G-C CATALOG



**GENERAL CEMENT MFG. CO.**  
ROCKFORD, ILLINOIS

## AUDIO RESPONSE CORRECTION (Continued from page 877)

cuit is a pentode the impedance at resonance of the tuned circuit should be at least equal to that of the following grid resistor and at least twice, preferably three or four times, the value of the usual plate load resistor. Typical tuned-circuit filters are shown in Fig. 6.

### NEGATIVE FEEDBACK

A simple way of obtaining a boost or accentuation at low or high frequencies is to provide a large degree of negative or inverse feedback and to reduce this feedback at the frequencies to be boosted. Condensers are employed to give this effect. A series condenser restricts the low frequency feedback, giving a bass boost; a condenser connected between the inverse feedback line and ground reduces the feedback at the higher frequencies giving a treble boost. These methods of compensation are largely employed by set designers to make up for deficiencies in loudspeakers and baffles.

In set design, the high frequencies are attenuated due to sideband cutting and considerable compensation is necessary, but in the design of audio amplifiers to follow pickups the problems are different. If (mind the IF) any high-frequency boost is needed, it should be limited in value and should occur only in a frequency band well away from the top resonant frequency. If a shunt condenser is employed in the negative feedback network, such a condenser should be very small. Typical values are given in Fig. 7.

More low-frequency compensation is required after a pickup than after a radio tuner, so the series condenser employed to reduce low-frequency feedback will be smaller. The bass boost is sometimes greater than anticipated owing to the feedback becoming positive at very low frequencies. Take care that there is not too much phase change in the amplifier, otherwise excessive feedback may take place at low or high frequencies, resulting in motorboating or a high-pitched whistle or hiss.

A procedure seldom employed but none the less effective is to use negative feedback direct to the pickup, arranging the circuit so that the amount of feedback is proportional to the pickup's impedance. This results in automatic compensation for the pickup resonances, for at these frequencies the impedance is high. Condensers can be placed in the feedback network to give bass boost and high-frequency compensation. To keep the amount of feedback independent of the volume, the volume control may be placed after the first tube, the output of the pickup being reduced to prevent overloading. This is shown in Fig. 8. Enthusiasts who have tried this circuit claim that it makes a cheap magnetic pickup sound like a first class crystal (which means that it is easy to obtain excessive bass)!

# RADOLEK

## Radio-Electronic Service Parts



Large stocks assure the finest and most complete selections of all available items at lowest prevailing prices. Thousands of active buyers depend on us for their entire Radio repair and replacement requirements. Because we understand service problems, every order is expedited for delivery in double quick time. Everything we do is planned for convenience and satisfaction to our customers. You will find it profitable to make Radolek your buying headquarters.

### FREE BUYING GUIDES

Because of existing conditions we keep our customers right up to the minute on available merchandise by releasing supplements frequently instead of sending our regular Big Profit Guide once a year. Send the coupon now to get these Free Buying Guide Supplements as they are issued.

**FREE!**

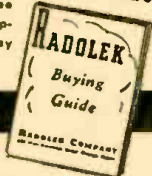

### FAST SERVICE!

RADOLEK CO., Dept. C-118  
601 W. Randolph St., Chicago 64 Ill.

Please send FREE Buying Guide Supplements

NAME \_\_\_\_\_

ADDRESS \_\_\_\_\_

**ORDER FROM RADOLEK**

**Porcelain Low Loss Octal Sockets**  
with Standard Value Resistors and Condensers wired on. (All Parts Brand New). One dozen \$1.00.

**GREENWICH SALES CO.**

50 Cortlandt Street

New York 7, N. Y.

# TRUTONE

### ELECTRICAL APPLIANCES

Fluorescent Kitchen Unit.	\$5.25 ea.
Fluorescent Desk Lamp, Beautiful Finish, less bulb.	6.25 ea.
Bulbs for above.	.75 ea.
Single Burner Electric Stove, less Switch.	2.55 ea.
Single Burner Electric Stove, with Switch.	2.95 ea.
Double Burner Electric Stove, with Switch.	6.25 ea.
Non-Automatic Electric Iron.	4.75 ea.
Non-Automatic Toaster.	3.75 ea.
Radiant Bowl Heater.	4.25 ea.
Cabinet Type Heater.	12.00 ea.
Electric Brother DeLuxe Type.	13.75 ea.

### ELECTRICAL ACCESSORIES

Bakelite Caps.	.055 ea.
Rubber Caps.	.09 ea.
Electric Iron Elements.	.58 ea.
Nichrome Electric Stove Element.	.12 ea.
Bakelite Heater Plug.	.10 ea.
3 Way Cube Tap.	.11 ea.
Cord Connector.	.11 ea.
Replacement Toaster Element.	.75 ea.

### CORD SETS

6 ft. Appliance Cord with Plug.	.21 ea.
Electric Iron Heater Cord with Bakelite Plug.	.45 ea.
Electric Iron Heater Cord with Switch Plug.	.79 ea.
Broiler Cord 3 Contact Plug.	.65 ea.
15 ft. Garage Trouble Light.	1.95 ea.

### RADIOS AND PHONOGRAPHS

Superheterodyne 5 Tubes complete with Bakelite Cabinet and Tubes.	22.95 ea.
Superheterodyne 6 Tubes complete with Wooden Cabinet and Tubes.	26.95 ea.
Portable Phonograph complete with Tubes and Speaker.	29.90 ea.
Automatic Portable Phonograph complete with Tubes and Speaker.	49.95 ea.

### PREPARED ASSORTMENTS

100 1/3 Watt Resistors All Insulated.	2.98
100 1/2 Watt Resistors All Insulated.	3.98
100 1 Watt Resistors All Insulated.	4.45
50 2 Watt Resistors All Insulated.	3.98
50 200 Volt Paper Condensers.	2.48
50 Mica Condensers.	2.98
20 Dry Electrolytic Filter Condensers.	6.75
10 25 ft. Rolls Hookup Wire—Ass't'd Colors.	1.98
10 Volume and Tone Controls—No Switches.	1.98
100 Ft. Snelgell and Vinylite.	.98
10 Coils I.F., R.F., Ant. and Osc.	3.98
20 Water and Ceramic Band Switches.	3.98
20 Auto Suppressors.	2.98
50 Electrical Wiring Devices. Plugs, Taps, Bases, Elements, Fuses, etc.	5.00

### SEND FOR TRUTONE COMPLETE RADIO AND ELECTRICAL LIST

Terms: 25% deposit required with order. Balance C.O.D. Merchandise sent prepaid if full remittance accompanies order.

## TRUTONE PRODUCTS CO.

303 West 42nd Street, Dept. C, New York (18), N. Y.

## AMPLIFIER

### HIGH QUALITY CIRCUIT

For Musical, Mike & Phono  
2 Watts output at 1000 cycles

Your cost ..... \$5.10 less tubes

Write:

**STEWART MARSHALL CO.,**  
Terre Haute, Ind.

## REBUILDING A TELEVISER

(Continued from page 832)

types of switch to provide 3-pole, 3-position operation where the second and third positions are additive, each in turn to the first position. Capacity is added to the initial capacity for each of the lower frequency channels. If the special switch is unobtainable a 3-pole, 3-position switch can be used with individual capacitors provided to tune each channel. In the first case the highest frequency is adjusted first and each lower one in turn. If the second type of switch is used each channel is adjusted individually.

The oscillator frequencies to provide the proper intermediate frequencies for New York's stations will be: Audio i.f.—8.25 mc, Video 12.75 mc.

Channel 2 54-60 mc—Osc. Freq. 68 mc  
Channel 4 66-72 mc—Osc. Freq. 80 mc  
Channel 5 76-82 mc—Osc. Freq. 90 mc

An additional i.f. stage and the rebuilding of the audio i.f. as a true FM receiver for the sound channel is another worthwhile improvement.

The circuit for this is shown in Fig. I-1. Note that the added i.f. precedes the existing first video i.f. and is a composite of audio and video i.f. amplification at the intermediate frequencies. The audio is tapped at the same point as in the original circuit. It is now, however, in the plate of the first (composite) i.f. rather than the mixer plate. There follows (I-2) an i.f. stage at 8.25 mc, a limiter and discriminator, and the audio amplifier comprising a voltage amplifier and an output stage. The FM sound channel is essential for post-war television-sound reception.

The removal of the power components

from the chassis and their incorporation in a separate unit made room for the addition of the components for the FM audio i.f. system.

A Meissner 4.3 mc i.f. transformer for FM receivers was pressed into service by unwinding turns until the unit tuned to 8.25 mc. The discriminator transformer was constructed from the existing audio i.f. transformer in the kit. The secondary was tapped at the center and coupled from the center-tap with a 50- $\mu$ f capacitor to the plate side of the primary. This has proved more than just satisfactory. A photograph of the revised chassis arrangement is shown. The discriminator transformer is shown separately (Fig. 2).

Trap alignment procedure with a composite first i.f. for the audio channel and for the video channel in order to reduce the response of the latter to possible audio i.f. interference from the adjacent or co-channel is as follows:

The composite (first) i.f. trap is adjusted for minimum response to 14.25 mc at the video detector load. The 2nd i.f. (video) trap is tuned to 8.25 mc (max. response at FM limiter grid). The 3rd i.f. trap is tuned for minimum response at 14.25 mc, and the 4th i.f. trap is tuned for minimum response (at video detector) to 8.25 mc.

Proper alignment of the discriminator in the audio i.f. system can be made only with suitable instruments, although with great care in tuning, an amplitude-modulated signal generator may be employed. With this the i.f. amplifiers are tuned for maximum output at the intermediate frequency (8.25 mc). The discriminator primary is tuned for maximum response after first detuning the secondary. The secondary is then tuned for minimum response to the a.f. amplitude modulation. There are two peaks. The proper adjustment is the minimum response between the two peaks.

The separate power supply diagram is shown in Fig. 3. Two high-voltage transformers are connected in series to give approximately 4500 v.d.c. after rectification for the third anode (intensifier) of the 5CP type tube employed in the author's set. Potentials for second anode, deflection plates and focusing anode are obtained from dropping resistors comprising a bleeder across the high voltage supply. The low-voltage supply is included on the same chassis with high voltage. This high-voltage supply will deliver sufficient potential for tubes as large as 9 or 10 inches diameter. A 7-inch electrostatic deflection C-R tube type 7EP is listed, but we have been unable to obtain one. The larger types require magnetic deflection and will necessitate circuit changes in the sweep amplifier sections.

If higher anode potential is desired without removing components from the existing chassis this may be accomplished by connecting the high-voltage supply additively to the low-voltage

(Continued on page 881)

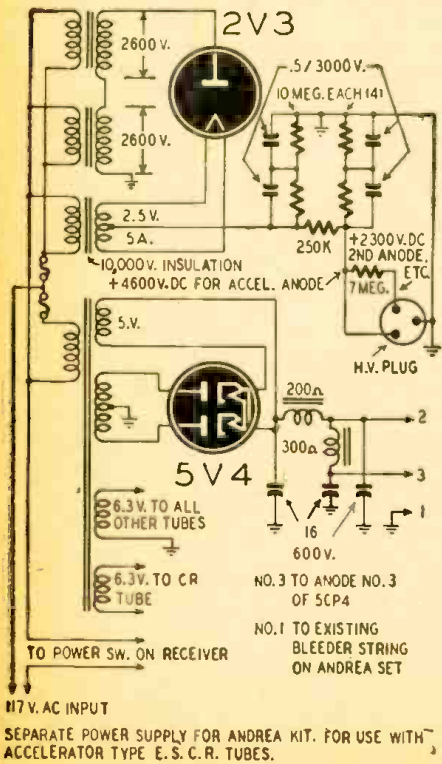

Fig. 3—Separate high-voltage power supply.

## Order from LAKE! You'll Make No Mistake! RADIO Cabinets & Parts



**NOW Available**

Postwar  
2 Post

**RECORD-CHANGER**

With luxurious brown leatherette portable case 15" L x 15" W x 10" D. Latest electronic developments make this modern record-changer the finest on the market today!

List Price... \$49.95 Dealer's net... \$29.97

Also blank table cabinets of walnut veneer in the following sizes, with speaker opening on left front side. (Note: 7" has center speaker orifice.)

#1	8 1/4" L x 5 1/2" M x 4" D	\$1.95
#2	10 1/4" L x 6 3/4" M x 5" D	\$2.75
#3	13 1/2" L x 7 5/8" M x 6 1/4" D	\$3.25
#7	10 3/4" L x 7" M x 5 1/2" D	\$2.50

\*Speaker Opening in center of front side.

All types of radio cabinets and parts are available at Lake's lower prices. A large stock is listed in our catalog.

**SERVICEMEN—RETAILERS**  
Join our customer list today.

Order our New Catalog Today!  
Get on our mailing list!

Dept. C



**LAKE RADIO SALES CO.**  
615 W. Randolph Street, Chicago 6, Ill.

## Immediate Delivery!

	Your Net
Headphones, Signal Corps, 8000 ohms and 200 ohms, each	\$ 2.49
Lots of 10, \$22.00; write for quantity prices	
Two post V.M. record-changer; it provides manual or automatic playing of ten standard 12" or twelve 10" discs with a minimum of waiting time between records	18.95
Phonograph motor for 110 volt A.C., 60 cycles and pickup that lists at \$10.00; both for...	7.95
Telegraph keys with cutout switch	.95
2500 mfd. 3 volt F.P. condensers	.49
Kit of twenty 5, 10 and 25-watt vitreous enameled resistors	1.89
Kit of ten bashtub condensers up to 1 mfd. 400 V.	1.95
8" P.M. speakers	3.59
5Y3G tubes	.39
5Y3GT tubes	.39
6J5 tubes	.48
12A6GT tubes	.89
10-12 tube power transformer, 6.3 V. winding; 100 Ma.	3.69

Plus shipping charges

Write for our illustrated literature featuring all types of radio parts and tubes

**ARROW SALES, INC.**

59 West Hubbard St. Dept. D Chicago 10, Illinois

## THE YEAR'S BIGGEST OFFER

**10 lb. Radio Parts Assortment**

A "find" for the radio serviceman. Hundreds of valuable radio parts, including coils, resistors, trimmer condensers, lugs, transformers, switches, hardware, etc.

Only ..... \$2.95

Write for radio parts circular

**RANDOLPH RADIO STORES**  
609 W. Randolph St. Chicago 6, Ill.

**Ted McElroy**

World's Largest Manufacturer of  
Wireless Telegraphic Apparatus  
COMPLETE CENTRAL OFFICE EQUIPMENT

**McElroy Manufacturing Corp.**  
82 Brookline Avenue • Boston, Massachusetts

# MILO

Your "Q" for Quality

IMMEDIATE DELIVERY

WESTON Model 798

THE COMPLETE MUTUAL CONDUCTANCE TUBE CHECKER AND ANALYZER

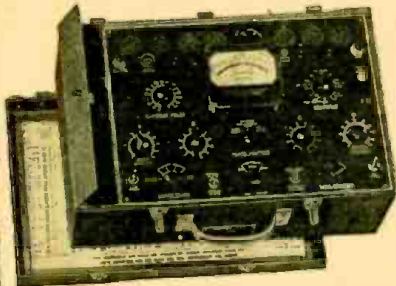

\$187.<sup>00</sup> Net

### Features

- Mutual Conductance or "Good-Bad" readings on all receiving type tubes.
- Complete volt-ohm-milliammeter ranges in addition to tube testing facilities.
- Tube checker ranges—3000/6000/12,000 micromhos
- New Patented test circuit using differential frequency system.
- Tubes tested with a high frequency signal (5 kc)
- Adjustable Plate, Screen, Signal and Grid Bias voltages.
- Hot neon leakage test between any two tube elements
- Analyzer ranges:
 

Volts AC	Volts DC
7.5/150/750	7.5/150/750
Current	Resistance
7.5 Milliamperes DC	100,000 Ohms
150 Milliamperes DC	1,000,000 Ohms

## New DU MONT

CATHODE-RAY OSCILLOGRAPH

Type 274 \$99.<sup>50</sup> Net

### function

The Du Mont Type 274 Cathode-ray Oscillograph is an inexpensive, general purpose instrument designed for routine laboratory and production testing, and for radio servicing. Featuring a 5" cathode-ray tube in a compact, portable, versatile oscillograph, the Type 274 fulfills a long standing need in the instrument field.

Have complete stock ON HAND of Aerovox, Simpson, Hammarlund, I.R.C., B&W, Utah, Premax and other nationally known parts and equipment.

If not rated, 20% with order, balance C.O.D.

Dept. C.

# MILO



Radio and Electronics Corp.

200 Greenwich St., N. Y. 7, N. Y.  
BEekman 3-2980-1

Export Div.—WESTERN INTERNATIONAL  
168 WASHINGTON ST., N. Y. 6, N. Y.

# COMMUNICATIONS

## APPEARS DISSATISFIED WITH EDITORIALS

Dear Editor:

This is directed to the attention of whoever writes the "Communications" column—just print it if you dare.

After reading the editorials in the last three or four copies of your publication, count me, and at least 40 GI's and hams, off your purchasing list.

Maybe we have been presented in a distorted view but while we are out protecting the necks of your money-hungry manufacturers, we thought we'd be given at least an EQUAL chance with the already established dealers. That opportunity seems to be a small recompense for three years of a man's life or the thousands of our buddies lives—maybe we're asking too much though.—Take for instance the RFC—the GI is getting the same old shaft again. After the government, the state and the big dealers pick over all the

good items, the little GI gets what little is left (and believe me gentlemen—it's true, I know from experience).

And maybe I'm a little dense, but perhaps you will explain why manufacturers won't allow a dealer to handle more than one line. I worked in perhaps the largest Ham Shack in the country and we sold competing sets side-by-side. Could it possibly be that with the resulting competition, the prices would come down to where they should be and the manufacturer would make only his normal profit? It seems like a very nice inter-political set-up — something REALLY SMELLS . . .

Thanks again for getting behind the serviceman and cutting his throat—we sure know who is on our side don't we ? ? ? ?

ROBERT C. FOSTER, W9JWY,  
Oak Park, Ill.

## HAS LITTLE TROUBLE GETTING MATERIAL

Dear Editor:

I was interested in Mr. Massey's letter in the May issue. Last October, I decided to obtain a good stock of radio parts. I talked to some of the local servicemen and they led me to believe that the serviceman was only able to get an occasional condenser or resistor.

When I presented my problems to the distributors, I found them courteous and willing to cooperate. One distributor told me, "Your appearance is neat and your records seem straight so I think that we will be able to fix you

up." I was unable to get a franchise for some of the most popular brands of radios but was able to get a new brand which I believe to be as good as, or better than, the well-known brands.

I found that if the product has a 90-day guarantee, the customer regards it as trustworthy. To date, I have nearly a complete stock of radio parts which I value at \$1000. I think that the other servicemen either didn't try hard enough or tried the wrong way.

RAY M. DIRBA,  
Wallis, Texas

## GETS ONLY TROUBLE—NO MATERIAL

Dear Editor:

I have just finished reading your editorial on page 529 of the May issue. I feel that it is a fair statement regarding the Ex-Serviceman vs. Radio Manufacturer and that it considered both sides of the controversy.

Here is another "squawk." How about the poor experimenter, home set builder and student? I have been trying to buy a two-gang variable condenser, 365  $\mu$ mf "superhet type" with trimmers, for more than two years. There just aren't any in this area and I have been unsuccessful in getting them in the mail-order houses in Chicago. Some types of tubes are also very scarce.

There are a lot of new sets being built by the manufacturers and they have the condensers. Why should all of them be taken by the manufacturer? It is very discouraging not to be able to get vital parts. It makes a fellow want to chuck the whole business out of the window and try some other line.

The only reason that I am writing this at all is that I feel that I am only one of a vast army of students and experimenters who suffer from the same situation. Can something be done to give us fellows just a trickle of the necessary parts?

C. G. LYTLE,  
Vancouver, Wash.

## HAS GOOD LUCK WITH POSTWAR 2-TUBER

Dear Editor:

You published in your March 1944 issue an article by Homer L. Davidson entitled "A Postwar 2-Tuber," which I built recently. I have so much good luck with it that I use it as much as my SX28. The panel size is 4½ inches wide by 6 inches high and the chassis extends only 4½ inches

from the back of the panel. Using this little set on my outside antenna I am able to operate a small speaker. With headphones there are few sizeable stations which cannot be received on it.

KARL HEIN,  
Kalamazoo, Michigan.



## Civilian Radio Jobs Wanted

### FREE WANT-AD SERVICE

By Former Soldiers, Sailors, Marines

Radio-Craft offers its help-wanted columns free for the use of honorably discharged men in the armed services. State the type of position you seek, preferred locality, your experience, education, and other details. Confine ad to 50 words, or less. Supply name and address. Army veterans send section number or photostat of discharge paper. Navy men send photostat of discharge paper. Address RADIO-CRAFT, Classified Ad. Dept., 25 West Broadway, New York 7, N. Y. Your ad will contain a box number and replies will be forwarded to you.

**RADIO-RADAR Tech.:** 3 yrs. div. exp., 4 yrs. army radar, all types. J. Finkel, 238 Sutter Ave., Brooklyn 12; DI 6-9282.

**RADIO MECH.—Radio school grad,** wants job as apprentice. T. J. Fornabia, 418 E. 119th St., New York 35.

**RADIO TECH.,** 26, married; civ. and Army exp. J. Moretti, 4054 Carpenter Ave. N. Y. 68.

**ENGINEER, BSME, Penn. State,** young, married; exp., des., development; electronics tech. S. Kozuek, 1554 52d St., Brooklyn 19; WA 9-6717.

**RADAR TECH.,** ex-station chief charge of maint. repair; 4 yrs. theory, practice, microwave equip. Box AT-15, 2/2 Radio-Craft, 25 West Broadway, New York 7, N. Y.

**RADIO SCHOOL GRADUATE.** Desires position as radio repairman. Some experience and knowledge of FM. Age 31, married, willing worker. Vet. Morris Zeig, 674 Ashford St., Brooklyn 7, N. Y.

**TECHNICIAN-RADAR OPER.** 2nd class radio telegraphy and telephone licenses. Army and civilian schooling, 25 yrs. of age. Call FL4-4712 or write 148-09 Northern Blvd., Flushing, N. Y.

**RADIO REPAIRMAN,** part-time; student; 4 yrs. exp. 1st-c. photo lic. M. Gottlieb, 1745 Rulton Avenue, N. Y. C. 57. LU-8-4375.

**RADIO TECH.:** Civilian, Army exp. radar, electronics; prefer laboratory work. M. Zwerin, 3093 Brighton 4th Street, Brooklyn 24, DE 2-1009.

**RADIO TECH.:** 2 yrs. Navy radar exp.; 3 yrs. coll. elect. eng. H. Haberman, 450 New Lots Avenue, Brooklyn 7.

**RADIO REPAIRMAN:** Have F.C.C. 2nd-class Commercial License; have 5 yrs. experience on FM & AM equipment. Martin Rubin, 575 Ocean Avenue, Brooklyn 26, N. Y.

**TECHNICIAN:** 5 yrs. experience. Engineering Student, Laboratory work preferred; references. Elton Nachman, 45 Park Avenue, Mt. Vernon, N. Y.

**ELECTRONIC TECH.,** desires installation, maintenance, development or repair work; license; B.S. H. W. Kohn, 577 Hunterdon Street, Newark 8, N. J. Bielow 3-1360.

**RADIO MECHANIC:** 3 yrs. exp.; work radio store; willing learn; chauff. lic. A. Grosso, 252 Mott St., New York 12.

**RADIO TECH.—1/c phone,** 2/c tel.; grad. RCA; salary secondary to apply. M. Blumenthal, 208 Beach 91 Street, Rockaway Beach, N. Y.

**RADIO, ELECTRICAL** Laboratory assistant, Bklyn Tech. grad. (electrical), two years S.C. Communications, familiar tools, drawing. I. Wolf, 61 Leo Ave., Bklyn, N. Y.

**TRAINEE—**Three years army experience on Electronic equipment. Desire an opportunity in field. Stanley Repeck, 311 Battle St., Brooklyn 2, N. Y., Box No. 8V-1.

**RADIO REPAIR,** civilian and army exp. RCA graduate. C. Schwartz, 134 Penn St., Bklyn, N. Y. 11.

## OPPORTUNITY AD-LETS

Advertisements in this section cost 20 cents a word for each insertion. Name, address and initials must be included at the above rate. Cash should accompany all classified advertisements unless placed by an accredited advertising agency. No advertisement for less than ten words accepted. Ten percent discount six issues, twenty percent for twelve issues. Objectionable or misleading advertisements not accepted. Advertisements for October, 1946, issue must reach us not later than August 23, 1946. Radio-Craft • 25 W. B'way • New York 7, N. Y.

**HAMS AND S.W. FANS 2 1/2 METER RECEIVER.** Brand new. Also preselectors, 10 to 20 meters. Write for details. Constant Electric, 112 Cornelia Street, Brooklyn, N. Y.

**"RADIOBUILDER"—PARTS, DATA, SAMPLE 10C.** Laboratories, Box 1-b, San Carlos, California.

**USED CORRESPONDENCE COURSES, EDUCATIONAL** and Technical Books Bought, Sold, Rented, Catalog Free. Educational Exchange, Henagar, Ala.

**BUILD YOUR OWN RADIO 5 TUBE SUPER HET KIT** complete with tubes and walnut cabinet using 50L6-35Z5-12SA7-12BK1-12SQ7. Easy to wire. Your cost \$16.95. McGee Radio Co., 1330 Broadway, Denver, Colo.

**MAGAZINES (BACK DATED)—FOREIGN, DOMESTIC,** arts, books, booklets, subscriptions, etc., etc. Catalog 10c (refund). Cicerone's, 863 First Ave., New York 17, N. Y.

**AMATEUR RADIO LICENSES, COMPLETE CODE** and theory preparation for passing amateur radio examinations. Home study and resident courses. American Radio Institute, 101 West 63rd Street, New York City. See our ad on page 884.

**CORRESPONDENCE COURSES AND SELF-INSTRUCTION** books, slightly used. Sold, Rented, Exchanged. All subjects. Satisfaction guaranteed. Cash paid for used courses. Complete information and 92-page illustrated bargain catalog free. Write—NEELSON COMPANY, Dept. 2-89, Chicago 4.

**RADIO TUBES, PARTS WHOLESALER, BULLETIN 3c.** Henshaw Radio Co., 3313 Delavan, Kansas City, Kansas.

## REBUILDING A TELEVISER

(Continued from page 879)

supply. To perform this operation the "cold" (minus) end of the high-voltage transformer is connected to the B+ end of the low-voltage power supply at point L in the diagram of Fig. 1 (No. 3 pin of the speaker plug). The high-voltage filter condenser is removed from ground and connected to point L and the last 1-meg resistor in the high-voltage bleeder string is removed from ground and connected to the plus of the low-voltage supply at the No. 3 pin of the speaker plug.

The series-connected power supply is shown at J.

**Warning:** Remember that the voltages used in these supplies are dangerous. Never work on the set with the power turned on.

With a separate power pack, an FM audio section, extra i.f. stage and provision for at least the three channels below 100 mc, the receiver will be comparable to any of the new sets at three times its original cost. If electrostatic deflection kinescopes of 9- or 10-inch diameter become available they can probably be substituted with no change necessary other than socket connections. The larger screen tube may require higher deflection voltages. This would involve additional sweep amplification.

Photographs made directly off the screen of the receiver on which the above changes have been made are shown to



Typical screen pattern before the changeover.



Images are much better with the new hookup. illustrate the effect of the changes. The "VE" image was made prior to the improvement of the receiver. Hum can be seen in the wavy verticals of the VE characters. The "Today's News" photograph was made recently. Improvement in contrast, detail and absence of the hum components are noticeable.

## HERSHEL'S

### LOW PRICED SPECIALS

Famous for low prices and quick delivery

#### DYNAMOTOR—6 or 12 V

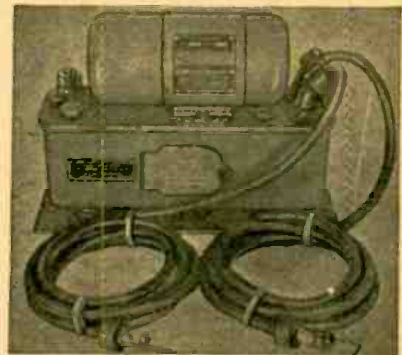

500 VDC at 160 MA Mounted on box with circuit breakers, relays, interference filter and two 10' cables. Army Surplus. **\$9.95**

6.3V. 6A. 110 V-60 cy. Fil Trans ..... **\$1.49**

28V. 2A 110 V-60 cy. Trans. .... **\$1.29**

30 mc Silver Slug Tuned single I.F. In can ..... **.29**

#### NAVY 8N-I.I.F.F.

#### TRANSMITTER & RECEIVER



A 24 tube unit that may be easily converted to 144 mc transmitter and receiver. Supplied less power transformer and tubes. **\$14.95**

Oil filled paper condenser IMFD 600 w.v.d.c. .... **.39**

Oil filled paper condenser IMFD 1000 w.v.d.c. .... **.69**

Tubes VR 150 ..... **.49**

Tubes 955, 9004 ..... **.65**

1T4, 3Q4, 3S4 6SN7, 12H6, 12SH7, ..... **.49**

200 W. 75M ohms Bleeder ..... **.49**

100W 2500 ohms Bleeder Var. .... **.49**

Johnson 25W proclin sockets, 4 prongs ..... **.39**

3000 WVDE .002 Mica 2.5 Amp. 300 KC ..... **.89**

20% DEPOSIT WITH ALL C.O.D. ORDERS

#### HERSHEL RADIO CO.

5249 GRAND RIVER, DETROIT 8, MICH.

## Do you need

### BINDING POSTS?



The XL PUSH POST with its Spring Action assures Constant Contact and quick connection.

Manufactured in All Aluminum Type M at 12c each.

Aluminum Body, Bakelite Top Type B1

Types CP or NP, ALL BRASS-STAINLESS STEEL SPRING & PIN, PROVEN

by 240 HR. SALT SPRAY TEST as NON-CORROSIVE at 20c each.

Manufacturers and Dealers Liberal Discounts

#### X. L. RADIO LABORATORIES

420 West Chicago Ave., Chicago 10, Ill.

Automobile radiotelephones will be available to New York subscribers this Fall.

# a Sensational TERMINAL Value!

## PRECISION

WIRE WOUND RESISTORS  
IRC - SHALLCROSS - MADISON

For Meter Multipliers, High Fidelity Amplifiers and other applications where 1% tolerance is required.

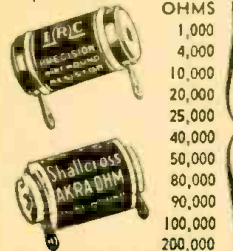

OHMS  
1,000  
4,000  
10,000  
20,000  
25,000  
40,000  
50,000  
80,000  
90,000  
100,000  
200,000

**35¢** EACH

**3 FOR \$1.00**

.5 megohm **75c** each, **3 for \$2.00**  
1.0 megohm **95c** each, **3 for \$2.50**

## METER SPECIALS!

G.E.  $3\frac{1}{2}$ " Round  
0-20 Microamperes  
Scale calibrated 0-100, Net **9.95**  
DeJur  $3\frac{1}{2}$ " Round  
0-200 Microamperes, Net **6.95**  
Minimum order \$2.00. No C.O.D.'s

We pay postage anywhere in U.S.A.

**TERMINAL**  
*Radio Corporation*  
85 CORTLANDT ST. N. Y. 7, N. Y.  
WOrth 2-4415

## RISCO SPECIALS Immediate Delivery

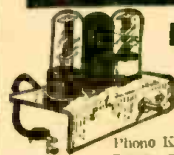

### PHONO AMPLIFIER

3 tube A.C.-D.C.  
completely wired  
with vol. and  
tone controls **\$3.50**

Phono Kit with 3 tubes—5" speaker **\$7.95**  
DETROLA RECORD CHANGER **\$17.50**  
VM MIXER CHANGER **\$17.95**

**ASTATIC**  
Curved Arm  
L-70  
Crystal Pickup



**\$2.19**

**GTC 50L6**  
Output Trans.  
**53¢**

INSULATED RESISTOR KIT  
100 assorted— $\frac{1}{4}$ ,  $\frac{1}{2}$ , 1 watt **\$2.10**  
By-Pass condenser kit  
15 assorted—all 800V **.89c**  
Emerson 20-20-150V. elect. cond. **.44**  
Osc. coil center tapped—456kc. 12SA7 **.19**  
25 asstd. mica cond.—color coded **.89**  
Phosphor bronze dial cable. 25 ft. **.25**  
Signal Corps Telegraph keys with cutoff switch **.75**  
25% Refund on C.O.D. Orders  
FREE: Send for Catalog C

**RISCO SALES CO.**  
WHOLESALE RADIO DISTRIBUTORS  
224 E. 65th ST., NEW YORK 21, N. Y.

### New Photo Electric Unit

For numerous control applications such as burglar alarms, industrial safety controls, automatic counters, or in conjunction with a chime or bell to announce entrance of persons in stores and offices. For A.C. Complete with all tubes **\$11.95** and built-in SPDT relay.



**ADSON RADIO CO.**  
221 FULTON ST. NEW YORK 7, N. Y.

## INDEX TO ADVERTISERS

Adson Radio Co.	882	National Radio Institute	809
Mitchell Adv. Agency		Van Sant, Dugdale & Co.	
Aerovox Corp.	860	National Schools	817
Austin C. Lescarbours & Staff		The Mayers Co.	
Allied Radio Corp.	857	National Union Radio Corp.	810
George Brodsky		Hutchins Advertising Co., Inc.	
Almo Radio Co.	868	Newark Electric Co.	865
E. L. Brown Co.		Charles Brunelle Advertising	
American Parts, Inc.	877	Niagara Radio Supply	856
American Television Institute	820	Burke and Wayburne	
Turner Adv. Agency		Ohmite Mfg. Co.	862
Amplifier Co. of America	873	The Fensholt Co.	
Sternfield-Godley, Inc.		Olson Radio Warehouse	866
Arrow Sales, Inc.	879	Jessop Advertising Co.	
Sander Rodkin Adv. Agency		Onan & Sons, D. W.	855
Atlas Electronics Co.	844	Graves and Assoc.	
Mitchell Advertising Agency		Opportunity Adlets	881
Atomic Heater & Radio Corp.	855	Pa-Kette Radio Co.	882
W. Montague Pearsall		Arrow Advertising Agency	
Audel Publishers	877	Panoramic Radio Corp.	Inside Front Cover
Grant & Wadsworth		Shappe Wilkes, Inc.	
Audio Sales Co.	872	Pyramid Electric Co.	Inside Back Cover
Mitchell Advertising Agency		The Arnold Cohan Corp.	
Balizer, Peter	872	Radio Corporation of America	816
Bell Telephone Labs	848	J. Walter Thompson Co.	
N. W. Ayer & Son		Radio Dealers Supply Co.	875
Buffalo Radio Supply	871	H. J. Gold Co.	
International Advertising Agency		Radio Electric Service Co.	875
Burstein-Applebee Co.	874	David Zibman Adv.	
Frank E. Whalen Adv. Co.		Radio Ham Shack	867
California Radio & Electronics Co.	811	Kupsick Adv. Agency	
Mitchell Advertising Agency		Radio Maintenance	812
Cannon Co., C. F.	882	Shappe-Wilkes Adv. Agency	
M. J. Werner Adv.		Radio Product Sales Co.	861
Capitol Radio Engineering Institute	818	Barton A. Stebbins Adv. Agency	
Henry J. Kaufman & Associates			
Cleveland Institute of Radio Elecs.	863, 872	RADIO SCHOOL DIRECTORY—See Page 884	
Kenneth Kolpein		American Radio Institute	
Communications Equipment Co.	859	Sternfield-Godley, Inc.	
Borough Advertising Co.		Baltimore Technical Institute	
Concord Radio Corp.	853	Candler System Co.	
E. H. Brown Adv. Agency		Rand-Ries Adv., Inc.	
Constant Electric	877	Commercial Radio Institute	
Coyne Electrical School	852	Electronics Institute, Inc.	
Phil Gordon Agency		Lincoln Engineering School	
Crabtree Wholesale Radio	863	Buchanan-Thomas Adv.	
DeForest's Training, Inc.	815	Melville Radio Institute	
MacDonald Cook Co.		Seidell Adv.	
Dow Radio	872	RCA Institutes	
Electro-Voice Corp.	Back Cover	Tri-State College	
Henry H. Teplitz		Clem J. Steigmeyer Adv.	
Free Want Ad Service	881	Western Radio Institute	
General Cement Mfg. Co.	878	YMCA	
Turner Adv. Agency		Cecil & Presbrey	
General Electric Co.	864	Radionic Equipment Co.	873
Maxon, Inc.		Hirshon-Garfield, Inc.	
Greenwich Sales Co.	878	Radio Wire Television	869
Harrison Radio Co.	870	Reiss Adv. Agency	
Altomari Advertising Agency		Radolek Company	878
Hershel Radio Co.	881	Turner Co.	
Highbridge Radio-Television & Appl. Co.	883	Randolph Radio Stores	879
Howard House	855	Reed Mfg. Co.	863
N. W. Ayer & Son		Risco Sales Co.	882
Kelvin Electronics Co.	853	Diener & Dorskind	
Sternfield-Godley, Inc.		Scenic Radio & Electronics Co.	875
Kwitheat Div. Sound Equip. Corp.	871	Sigmon's Radio Supply	874
West-Marquis, Inc.		Advertising, Inc.	
Lake Radio Sales Co.	879	Solar Capacitor Sales Corp.	864
Sander Rodkin Adv. Agency		O. S. Tyson & Co., Inc.	
Leeds Radio Co.	874	Sprague Products Co.	846, 847
Mitchell Adv. Co.		Harry P. Bridge Co.	
Liberty Sales Co.	844	Sprayberry Academy of Radio	813
Sternfield-Godley, Inc.		Harry P. Bridge Co.	
Lifetime Sound Equipment Co.	866	Sterling Electronic Co.	863
The Miller Agency Co.		Stewart Marshall Co.	878
McElroy Manufacturing Co.	879	Superior Instruments	851
Shappe Wilkes Adv. Agency		Mitchell Adv.	
McMurdo Silver Co.	819	Supreme Publications	845
Edward Owen & Co.		Henry H. Teplitz Adv.	
Maedel Publishing House	883	Sylvania Electric Products, Inc.	849
Manuscripts Wanted	875	Newell-Emmett Co.	
Marcotte Co., A. J.	883	"Tab" Technical Apparatus Bldrs.	869
Morlock Adv. Agency		Mitchell Adv. Agency	
Maritime Switchboard	868, 871	Terminal Radio Co.	882
Metropolitan Electronic & Inst. Co.	876	Regent Adv. Agency	
Mitchell Advertising Agency		Triplitt Electrical Instrument Co.	861
Milo Radio & Elec. Corp.	880	Western Adv. Agency	
Burke & Wayburne		Trutone Products Co.	878
Murray Hill Books, Inc.	843	Terrill Belknap Marsh and Assoc.	
Harry P. Bridge		Verfrod Corporation	862
N. J. Industrial Company	883	Mitchell Adv. Agency	
National Plans Co.	857	World Radio Laboratories	859
National Radio Distributors	873	Pfeiffer Adv. Agency	
Burke & Wayburne		X L Radio Laboratories	881



## CANNON-BALL

Phones have kept in the lead over twenty-five years through real performance. Write for Folder R-9, illustrating complete line of rugged, unusually sensitive, dependable Cannon-Ball Headsets.

Scientifically built Heavy duty magnets greatly increase their efficiency.

**C. F. CANNON COMPANY**  
SPRINGWATER, N. Y.

*Headset Headquarters*



## NEW TINY POCKET SIZE RADIO!

Slips in your pocket or purse—WEIGHT only 3 ozs. Complete. READY TO PLAY as shown with self-contained phone for personal use. Smooth, durable black and silver plastic case. New patented Fixed Crystal—NO TUBES, BATTERIES OR ELECTRIC PLUG IS REQUIRED. USUALLY RECEIVES LOCAL BROADCASTS CLEARLY without outside aerial wire.

GUARANTEED TO WORK when connected and used according to instructions sent with each radio. Can be used in homes, offices, hotels, cabins, bed, or other hours, etc.

**SEND ONLY \$1.00** (cash, money order, check) and pay postman \$2.00, plus delivery fees on arrival or send \$3.00 for postpaid delivery. IDEAL GIFT FOR CHILDREN OR ADULTS ALIKE! Get your PA-KETTE RADIO TODAY—NOW. Dealers in most cities.

**PA-KETTE RADIO COMPANY**  
DEPT. RC-9 KEARNEY, NEBRASKA

# BOOK REVIEWS

**ELECTRONICS FOR ENGINEERS**, by John Markus and Vin Zeluff. Published by McGraw-Hill Book Company. Stiff cloth covers, 9x11 inches, 390 pages. Price \$6.00.

This book contains a wealth of technical information and data for radio and electronic engineers and engineering students. It is a compilation of 142 papers that have been printed in *Electronics* magazine since April 1930. The articles selected for this book have been in great demand as reference material for engineers.

The material is presented in the form of papers, data sheets, design charts and graphs. There are design charts and graphs covering all phases of communication work as well as electronic heating, mathematics and permanent magnets.

All material of a similar nature has been grouped together in a single chapter for easy reference. There are 28 chapters with the heading at the top of each page, so that it is not necessary to resort to the index to find the necessary references.

**WHY SMASH ATOMS?** by Arthur K. Solomon, Research Fellow in Physics and Chemistry, Harvard University; Staff Member, Radiation Laboratory, Massachusetts Institute of Technology. Published by Harvard University Press. Size 6½ by 9¼ inches, stiff cloth covers, 204 pages, illustrated. Price \$3.00.

The author has presented the subject of atomic reaction in a most interesting and lucid manner—we might almost say in a grand manner. He gives the names of men in science who made important discoveries along the upward path which culminated in the atomic bomb and the dawn of a new era in physics.

One valuable feature of the book is that the important ground work on simple electron and nuclear theory is explained in a clear and interesting style. The first chapter starts with the electron; then we learn something about the nature of the proton, the neutron, the nucleus and atomic number. Following chapters—with beautiful illustrations—are devoted to atom smashers, including the voltage doubler, the Van der Graff electrostatic generator, the Cyclotron and others.

Geiger counters and cloud chambers are explained clearly, as is the subject of uranium fission. Other chapters cover atomic energy, uranium, plutonium, application of nuclear energy in medicine, the atomic bomb, etc.

The excellent line illustrations by Katherine Campbell Duff lend an air of charm and a clear interpretation of the various actions in the new world of nuclear physics. An excellent glossary of atomic energy terms is provided, together with a complete index of the subjects covered in the book.—*H.W.S.*

**ELECTRICAL AND RADIO DICTIONARY**, by Dunlap and Haan. Published by American Technical Society. Stiff cloth covers, 6 x 8½ inches, 114 pages, plus page index. Price \$1.00.

This dictionary of words and terms used in electrical and radio fields is useful to the student or engineer. The words and terms are divided into two sections. In the first, words are defined as they apply to general electricity, in the second, definitions are given as used in radio.

Elsewhere in the book are numerous tables, charts, diagrams, formulas and symbols containing information and data most often sought by the student and engineer.

**THE RADIO AMATEUR'S HANDBOOK** (Twenty-third Edition—1946), by the Headquarters Staff of the American Radio Relay League. Published by the American Radio Relay League. Hard paper covers, 6½ x 9½ inches, 688 pages. Price \$1.00 in continental U. S. A.; \$1.50 elsewhere.

The ARRL Handbook, one of the most widely-read radio publications, needs no review or introduction to the radio-minded public. For years it has been a "must" on the bookshelf of radio engineers, operators and experimenters and anyone who has read or owned a copy invariably purchases the latest edition as soon as it leaves the presses.

This, the first peacetime edition in four years, is very similar in many respects to the 1945 edition. The close similarity between these editions is probably caused by lack of amateur experiment and development during the war years. The chapters on WERS and carrier-current communication have been omitted and more space given to material on antenna construction and v.h.f. equipment.

More than 200 pages are devoted to catalog section, listing the complete line of more than one manufacturer. A complete index, 10-pages, adds much to the utility of The Handbook.—*R.F.S.*

# MATHEMATICS FOR RADIO

Two volumes, prepared for home study. Book I (314 pp.) covers the algebra, arithmetic, and geometry; Book II (329 pp.) covers the advanced algebra, trigonometry, and complex numbers necessary to read technical books and articles on radio.

MAEDEL PUBLISHING HOUSE Room 117  
593 East 38 Street, Brooklyn, New York

Send me MATHEMATICS FOR RADIO AND COMMUNICATION as checked below. I enclose payment therefor with the understanding that I may return the book(s) within 5 days in good condition and my money will be refunded.

Name .....

Address .....

- Book I at \$3.75 plus 6c postage
- Book II at \$4.00 plus 6c postage
- Books I and II at \$7.75 postage prepaid

Foreign and Canadian prices 25c per volume higher

## OSCILLOSCOPE FOUNDATION KIT 5 INCH

Consisting of Case, Chassis, two shelves (right & left), tube shield and bracket, front panel, screen window frame, handle, plastic window socket, with 5CP1 Cathode Ray tube —  
Special \$18.95

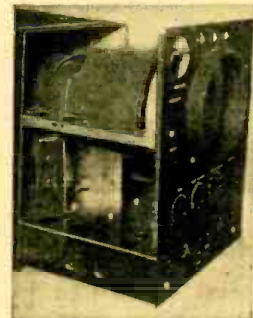

KIT without Cathode Ray tube ..... \$11.95  
5CP1 Cathode Ray tube only ..... 7.40  
Tube shield and bracket, only ..... 1.98  
3BP1—Cathode Ray Tubes ..... 5.25

HIGHBRIDGE RADIO TELEVISION  
AND APPLIANCE CO.

340 Canal Street New York 13, N. Y.

## PHONO AMPLIFIER

3-Tube, A.C.-D.C. Completely Wired  
Ready to Operate

**\$3.75**

(less tubes)



Uses 50L6-35Z5-12SQ7

**N. J. INDUSTRIAL CO.**

11 HILL STREET

NEWARK 2, NEW JERSEY

## MARCOT KEY MACHINE

Marcot No. 8 Key Machine Mounted on Cabinet ..... \$75.00  
Book on Modern Locksmithing ..... 3.95  
Auto Code Book and Auto Depth Keys ..... 12.50  
162 Doz. popular Key Blanks ..... 77.76  
Set Key Files, Tools, Pins, Springs, Thimble ..... 10.50  
\$179.71

A. J. MARCOTTE CO. 1200 N. Kedzie Ave. Dept. RC, Chicago 51, Ill.

# RADIO SCHOOL DIRECTORY

PREPARE NOW FOR SKILLED JOBS IN RADIO AND ELECTRONICS

**M**AKE a place for yourself in a new world of radio and electronics—a world in which revolutionary electronic developments will require highly specialized technical knowledge. Take a good course now to fit yourself for a good paying job. The training you need can be supplied by one of the schools advertised in this publication.

**RADIO**  
SERVICING  
BROADCAST ENGINEERING  
COMMERCIAL OPERATING  
FM—TELEVISION  
SHOP MATH  
HOME APPLIANCE  
REPAIRING

October Classes Now Forming

**Baltimore Technical Institute**  
1425 EUTAW PLACE  
BALTIMORE 17, MARYLAND

Veterans Accepted Under G.I. Bill  
Resident Courses Only

**RADIO COURSES**

- RADIO OPERATING • CODE
- RADIO SERVICING — ELECTRONICS
- REFRIGERATION SERVICING

Personal Counselling Services for Veterans  
Write for Latest Trade & Technical Catalog

**Y.M.C.A. TRADE & TECHNICAL SCHOOLS**  
4 W. 64th Street New York City

**SENDING SPEED**  
**CODE RECEIVING**

Be a "key" man. Learn how to send and receive messages in code by telegraph and radio. Commerce needs thousands of men for jobs. Good pay, adventure, interesting work. Learn at home quickly through famous Candler System. Write for FREE BOOK.

**CANDLER SYSTEM CO.**  
Dept. 3-K, Box 928, Denver 1, Colo., U.S.A.

**RCA INSTITUTES, Inc.**

Offer thorough training courses in all technical phases of

**Radio and Television**

DAYS—EVENINGS WEEKLY RATES

**VETERANS:** RCA Institutes is approved under G. I. Bill of Rights  
For Free Catalog Write Dept. RC-46

**RCA INSTITUTES, Inc.**  
A Radio Corporation of America Service  
75 VARICK STREET NEW YDRK 13, N. Y.

**RADIO ENGINEERING!**

VETERANS can complete work here in shortest possible time. Courses also in Civil, Electrical, Mechanical, Chemical, Aeronautical Engineering; Business Administration, Accounting, Secretarial Science. 63rd year. Enter Sept., Jan., Mar., June. School now filled to capacity. No applications can be accepted until further notice.

**TRI-STATE COLLEGE** 2496 College Ave. ANGOLA INDIANA

**RADIO**

Train with professionals. Complete. Intensified courses: Repair & Maintenance, Communications, High-speed telegraphy, SLP transcription, FCC exams, etc.

High School Students accepted for training as Merchant Marine Radio Officers. Gov't sponsorship available to veterans.

"A Radio School managed by radio men."  
45 W. 45th St., Dept. RC, New York 19, N.Y.

**MELVILLE RADIO INSTITUTE**

**COMMERCIAL RADIO INSTITUTE**

A radio training center for twenty-five years.

RESIDENT COURSES ONLY

Broadcast, Service, Aeronautical, Television and Marine telegraphy classes now forming. Literature upon request. Veteran training. Classes now forming for Oct. 1st.

Dept. C, 38 West Biddle St., Baltimore 1, Md.

**RADIO**

RADIO Technician and Radio Communications courses. Register now for new classes starting first MONDAY of each month. Day and Evening Classes.

**AMERICAN RADIO INSTITUTE**  
101 West 63rd St., New York 23, N. Y.  
APPROVED UNDER GI BILL OF RIGHTS.

**LEARN RAPID RADIO SERVICING**

Send for Free Information: "3 Ways to Learn Radio." Approved for Training Veterans.

**WESTERN RADIO INSTITUTE**  
1457 Glenarm, Denver 2, Colo.

**ELECTRONICS**

Electronic Technician Training Course. Qualify for Radio Communication (Commercial Government License); Radio Repair Service; or be an Industrial Electronic Technician. Register now for new classes starting every four weeks. Approved under G. I. Bill of Rights. Residence day and evening school. Write to

**ELECTRONICS INSTITUTE, INC.**  
21 HENRY, DETROIT 1, MICH.

Correspondence Courses in

**RADIO and ELECTRICAL ENGINEERING**

**ELECTRICAL ENGINEERING** Get good grasp of wide electrical field. Prepare yourself, at Low Cost, for secure future. Modern, simplified, you can understand quickly.

**RADIO ENGINEERING** Extra fine course in radio, publishes address, photo-electric work. Trains you to be super-service man, real vacuum tube technician. Servicemen needed badly. Diploma on completion. Tuition \$25, either course. Deferred payment plan. Get copies of school catalogs, student magazines, complete details. SEND NOW!

**FREE**

**LINCOLN ENGINEERING SCHOOL** Box 931C-91 Lincoln, Nebr.

**BLACK-LIGHT TELESCOPE**  
(Continued from page 826)

low current density, fine grain for high resolution, high voltage and vacuum operation, and insensitivity to caesium contamination, willemite has been used as the fluorescent material. In the preparation of the screen material, precautions are observed to insure an efficient screen of fine texture.

Willemite, in water suspension, is placed on the glass surface to be coated. A centrifuge is employed to lay down

the phosphor screen and the water is decanted off.

The completed tube, together with an ocular lens and infra-red optics, has unity magnification. Resolution is such as to resolve nearly 400 lines per inch.

A star of the fifth magnitude may be detected by the tube. This is equivalent to one-tenth of a candle-power at a distance of one mile—a very small amount of infra-red radiation, indeed.

Despite the high operating potential, the 4100-volt power unit is less than two pounds in weight. Two battery-operated models were produced, one using a small vibrator interrupter and one an impulse breaker closely resembling the hairspring assembly of a watch.

Powered by a single storage cell, the size of a flashlight cell, battery life is from one to two hours of operation in the first-mentioned type of supply, 50 hours in the second.

A third model employed a relaxation oscillator as the source of high voltage powered from the 117-volt line, rectified by another product of wartime research, a minute tube consuming but five hundredths of a watt in the filament.

The 1P25 tube being a recently-developed contribution to the art of electronics, mass production of the quantities necessary to supply the needs of our armed forces has presented countless problems in manufacture.

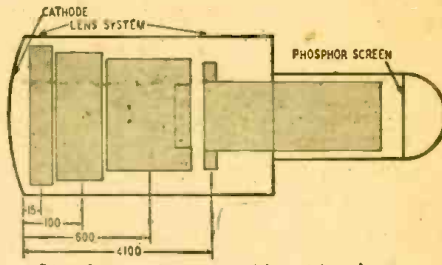

1P25 electron lens assembly, with voltages.

Defective operation occurs if, in the assembly and processing operations, even a slight contamination is introduced in the form of oils or vapors, metallic compounds or dirt. Therefore, extreme precautions toward cleanliness of parts and purity of atmosphere are observed.

Astigmatism in the completed tube appears as the result of misalignment of the electron lens assembly and members of the lens system being slightly out of round. This in turn tends to limit resolution.

However, the engineering staff of the corporation designed equipment and initiated specialized procedures and techniques so that during the war an average of over 1000 tubes per month were supplied by the production division of their vacuum tube laboratories.

In addition, large quantities of the complete unit, consisting of a Schmidt optics system for projection of the infra-red image upon the tube, an ocular lens system for image magnification and power supply, also a product of the engineering division, were supplied by the company. The entire assembly is contained within a sealed nitrogen-filled case for protection against moisture and dirt. Even submersion in water is not detrimental to operation.

A studio for radio and television is one of the features of the modernization plans of New York's Metropolitan Museum of Art, which include reconstruction of the present buildings. Below the studios will be an auditorium seating 1200 people, in which programs can either be originated or received.

# Portrait of a Very Happy Man



He's quite content now!  
He's found that he can  
kiss his capacitor  
worries goodbye --- be-  
cause Pyramid products  
are really good; they're  
modestly priced, and  
most important of all,  
Pyramid is delivering!!

WRITE FOR LITERATURE  
PYRAMID ELECTRIC COMPANY  
JERSEY CITY 6, N. J.

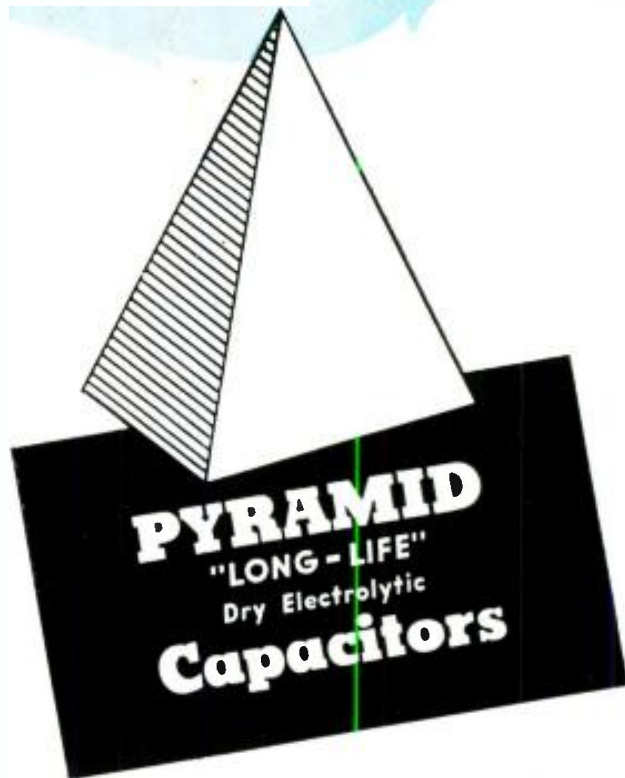

Announcing

# NEW Electro-Voice CARDYNE

Now you get More Features...  
More Advantages than ever... in a Single Head

## Cardioid Dynamic Microphone

New E-V developments bring you true cardioid unidirectivity... smooth, wide-range response... high output... and other desirable advantages in a rugged single-head dynamic.

Through the exclusive new E-V *Mechanophase*\* principle, the CARDYNE virtually eliminates unwanted sounds... gives you only the sound you want, with greater definition and fidelity. Substantially reduces background noise and reverberation. Increases effective working distance from microphone. Stops feedback. Permits increased loud-speaker volume. Gives extremely accurate pick-up and reproduction of music and speech... indoors and outdoors. Highly suitable for the most exacting sound pick-up work... in studio and remote broadcasting, disc and film recording, public address and communications.

Trim, modern, functional design, finished in rich satin chromium. Smooth, firm tilting action. "On-Off" switch. Ruggedly built to withstand severe operating conditions. Available in 50, 250, 500 ohms impedance, or Hi-Z (direct-to-grid, 25,000 ohms). Low impedances balanced to ground. Also available without "On-Off" switch. Send now for *Cardyne Bulletin No. 131*.

**CARDYNE II. Model 731.** List Price ..... \$75.00  
Frequency response, substantially flat, 30-12,000 c.p.s.

**CARDYNE I. Model 726.** List Price ..... \$55.00  
Frequency response, substantially flat, 40-10,000 c.p.s.

No finer choice than

# Electro-Voice

ELECTRO-VOICE, INC., 1241-G South Bend Ave., South Bend 24, Indiana  
Export Division: 13 East 40th St., New York 16, N. Y., Cables: Arlab



Cardioid (heart-shaped) Polar Pattern. Wide-angle front pick-up, horizontally and vertically, diminishes sharply to dead zone at rear. Sound at rear dead zone cancels out and is not reproduced. Solves everyday sound problems—in a great many applications.

Only the Cardyne Gives You All This!

- New E-V *Mechanophase*\* Principle
- True Cardioid Unidirectional Performance
- Reduces Background Noise, Reverberation
- Stops Feedback—Permits Greater Volume
- Relatively High Output
- New E-V Acoustalloy Diaphragm
- Substantially Flat, Wide-Range Response
- And other E-V Features

\*Patents Pending